



LK112 SERIES

LOW NOISE LOW DROPT VOLTAGE REGULATOR WITH SHUTDOWN FUNCTION

- OUTPUT CURRENT UP TO 150mA
- LOW DROPT VOLTAGE (350mV AT $I_{OUT}=150mA$)
- VERY LOW QUIESCENT CURRENT: 0.1 μA IN OFF MODE AND MAX 250 μA IN ON MODE AT $I_{OUT}=0mA$
- LOW OUTPUT NOISE: TYP 30 μV AT $I_{OUT}=60mA$ AND $10Hz < f < 80KHz$
- WIDE RANGE OF OUTPUT VOLTAGES
- INTERNAL CURRENT AND THERMAL LIMIT

DESCRIPTION

The LK112 is a low dropout linear regulator with a built in electronic switch. The internal switch can be controlled by TTL or CMOS logic levels. The device is ON state when the control pin is pulled to a logic high level. An external capacitor can be used connected to the noise bypass pin to lower the output noise level to 30 μV_{rms} . An internal PNP pass transistor is used to achieve a low dropout voltage.

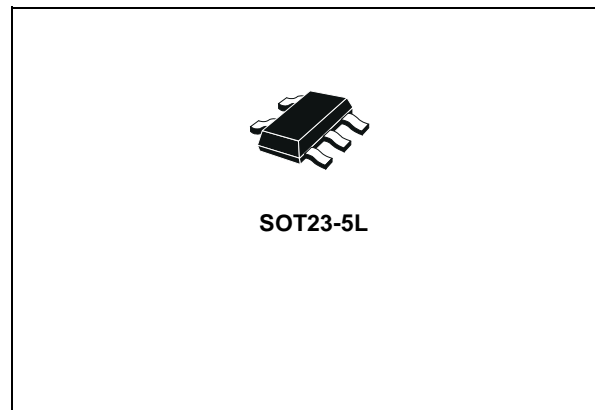

The LK112 has a very low quiescent current in ON MODE while in OFF MODE the I_q is reduced down to 100nA max. The internal thermal shutdown circuitry limits the junction temperature to below 150°C. The load current is internally monitored and the device will shutdown in the presence of a short circuit or overcurrent condition at the output.

SCHEMATIC DIAGRAM

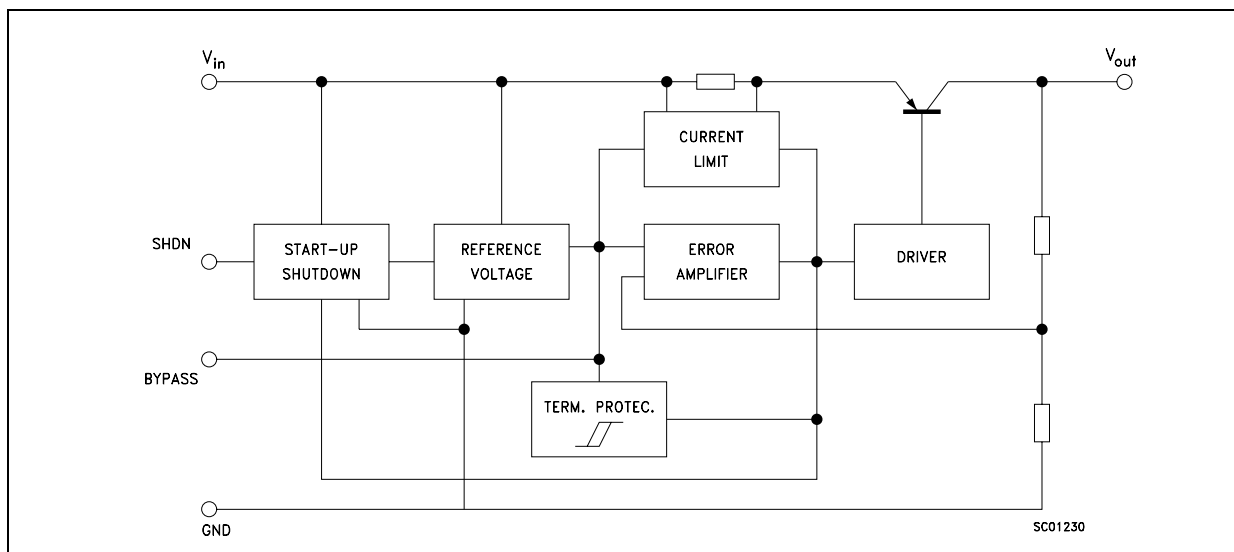

LK112 SERIES

ABSOLUTE MAXIMUM RATINGS

Symbol	Parameter ²	Value	Unit
V_I	DC Input Voltage	16	V
V_{SHDN}	Shutdown Input Voltage	16	V
I_O	Output Current	Internally limited	
T_{stg}	Storage Temperature Range	-55 to +150	°C
T_{op}	Operating Junction Temperature Range	-30 to +125	°C

THERMAL DATA

Symbol	Parameter	SOT23-5L	Unit
$R_{thj-case}$	Thermal Resistance Junction-case	81	°C/W
$R_{thj-amb}$	Thermal Resistance Junction-ambient	255	°C/W

CONNECTION DIAGRAM (top view)

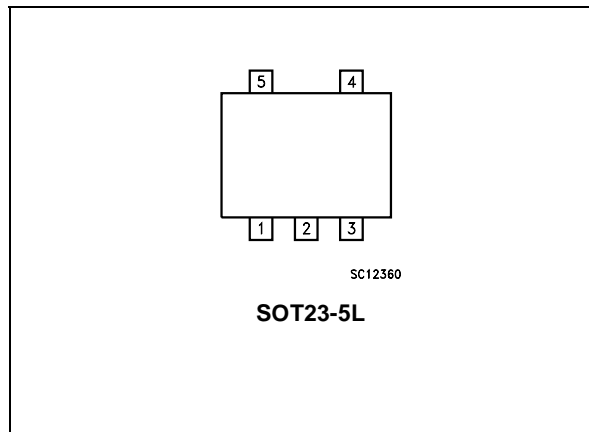

PIN DESCRIPTION

Pin N°	Symbol	Name and Function
1	SHDN	Shutdown Input: Disables the regulator when is connected to GND or to positive voltage less than 0.6V
2	GND	Ground Pin: Internally connected to the die attach flag to decrease the total thermal resistance and increase the package ability to dissipate power.
3	Bypass	Bypass Pin: Bypass with 0.1μF to improve the Vref thermal noise performances.
4	OUT	Output Port
5	IN	Input Port

ELECTRICAL CHARACTERISTICS FOR LK112 ($T_j = 25^\circ\text{C}$, $V_{IN}=V_{OUT}+1\text{V}$ (see Note 1), $I_{OUT}=0\text{mA}$, $V_{SHDN}=1.8\text{V}$, $C_I = 1\ \mu\text{F}$, $C_O = 2.2\ \mu\text{F}$, $C_{BYPASS} = 0.1\ \mu\text{F}$ unless otherwise specified)

Symbol	Parameter	Test Conditions	Min.	Typ.	Max.	Unit
I_d	Quiescent Current	ON MODE (except I_{SHDN})		175	250	μA
		OFF MODE $V_I = 8\text{V}$ $V_{SHDN} = 0\text{V}$		0	0.1	μA
V_O	Output Voltage	$I_O = 30\text{mA}$	(see table)			
ΔV_O	Line Regulation	$V_I = V_O+1\text{V}$ to $V_O+6\text{V}$, $V_O \leq 5.6\text{V}$		0.7	20	mV
		$V_I = V_O+1\text{V}$ to $V_O+6\text{V}$, $V_O > 5.6\text{V}$		0.8	40	mV
ΔV_O	Load Regulation	$I_O = 1$ to 60mA		15	30	mV
		$I_O = 1$ to 150mA		25	90	mV
V_d	Dropout Voltage	$I_O = 60\text{mA}$ (see Note 2)		0.17	0.24	V
		$I_O = 150\text{mA}$ (see Note 2)		0.29	0.35	V
I_O	Output Current Limit		150			mA
SVR	Supply Voltage Rejection	$V_I = V_O+1.5\text{V}$ $C_{BYP} = 0.1\ \mu\text{F}$ $C_O = 10\ \mu\text{F}$ $f = 400\text{Hz}$ $I_O = 30\text{mA}$		55		dB
eN	Output Noise Voltage	$B = 10\text{Hz}$ to 80KHz $C_{BYP} = 0.1\ \mu\text{F}$ $C_O = 10\ \mu\text{F}$ $V_I = V_O+1.5\text{V}$, $I_O = 60\text{mA}$		30		μVrms
I_{SHDN}	Shutdown Input Current	$V_{SHDN} = 1.8\text{V}$ Output ON		12	35	μA
V_{SHDN}	Shutdown Input Logic	Output ON Output OFF	1.8		0.6	V V
$\Delta V_O/T_j$	Output Voltage Temperature Coefficient	$I_O = 10\text{mA}$		0.09		$\text{mV}/^\circ\text{C}$

Note 1: for version with output voltage less than 2V $V_{IN}=2.4\text{V}$

Note 2: only for version with output voltage more than 2.1V

LK112 SERIES

ORDERING NUMBERS AND OUTPUT VOLTAGE

Part Number	Output Voltage	V _{OUT} Min	V _{OUT} Max	Test Voltage
LK112M13TR	1.3V	1.24V	1.36V	2.4V
LK112M14TR (*)	1.4V	1.34V	1.46V	2.4V
LK112M15TR	1.5V	1.44V	1.56V	2.4V
LK112M16TR	1.6V	1.54V	1.66V	2.4V
LK112M17TR	1.7V	1.64V	1.76V	2.4V
LK112M18TR	1.8V	1.74V	1.86V	2.4V
LK112M19TR (*)	1.9V	1.84V	1.96V	2.4V
LK112M20TR (*)	2.0V	1.94V	2.06V	3.0V
LK112M21TR	2.1V	2.04V	2.16V	3.1V
LK112M22TR (*)	2.2V	2.14V	2.26V	3.2V
LK112M23TR (*)	2.3V	2.24V	2.36V	3.3V
LK112M24TR (*)	2.4V	2.34V	2.46V	3.4V
LK112M25TR	2.5V	2.44V	2.56V	3.5V
LK112M26TR (*)	2.6V	2.54V	2.66V	3.6V
LK112M27TR (*)	2.7V	2.64V	2.76V	3.7V
LK112M28TR	2.8V	2.74V	2.86V	3.8V
LK112M29TR (*)	2.9V	2.84V	2.96V	3.9V
LK112M30TR	3.0V	2.94V	3.06V	4.0V
LK112M31TR (*)	3.1V	3.04V	3.16V	4.1V
LK112M32TR	3.2V	3.14V	3.26V	4.2V
LK112M33TR	3.3V	3.24V	3.36V	4.3V
LK112M34TR (*)	3.4V	3.335V	3.465V	4.4V
LK112M35TR (*)	3.5V	3.435V	3.565V	4.5V
LK112M36TR	3.6V	3.535V	3.655V	4.6V
LK112M37TR (*)	3.7V	3.630V	3.770V	4.7V
LK112M38TR	3.8V	3.725V	3.875V	4.8V
LK112M39TR (*)	3.9V	3.825V	3.975V	4.9V
LK112M40TR	4.0V	3.920V	4.080V	5.0V
LK112M41TR (*)	4.1V	4.020V	4.180V	5.1V
LK112M42TR (*)	4.2V	4.120V	4.280V	5.2V
LK112M43TR (*)	4.3V	4.215V	4.385V	5.3V
LK112M44TR (*)	4.4V	4.315V	4.485V	5.4V
LK112M45TR (*)	4.5V	4.410V	4.590V	5.5V
LK112M46TR (*)	4.6V	4.510V	4.690V	5.6V
LK112M47TR	4.7V	4.605V	4.795V	5.7V
LK112M48TR (*)	4.8V	4.705V	4.895V	5.8V
LK112M49TR (*)	4.9V	4.800V	5.000V	5.9V
LK112M50TR	5.0V	4.900V	5.100V	6.0V
LK112M55TR (*)	5.5V	5.390V	5.610V	6.5V
LK112M60TR	6.0V	5.880V	6.120V	7.0V
LK112M80TR	8.0V	7.840V	8.160V	9.0V

(*) Available on request

TYPICAL CHARACTERISTICS (unless otherwise specified $T_j = 25^\circ\text{C}$, $C_I = 1\mu\text{F}$, $C_O = 2.2\mu\text{F}$, $C_{BYP} = 100\text{nF}$)

Figure 1 : Output Voltage vs Temperature

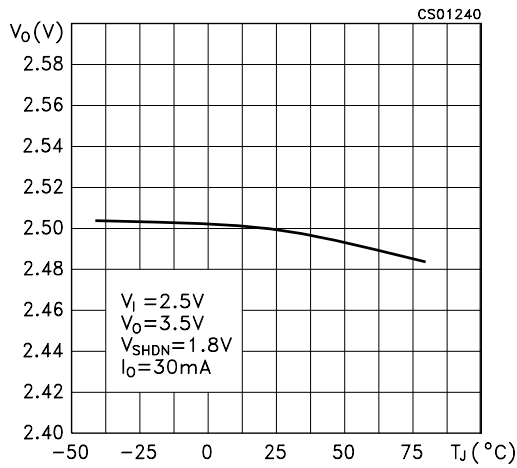

Figure 2 : Output Voltage vs Temperature

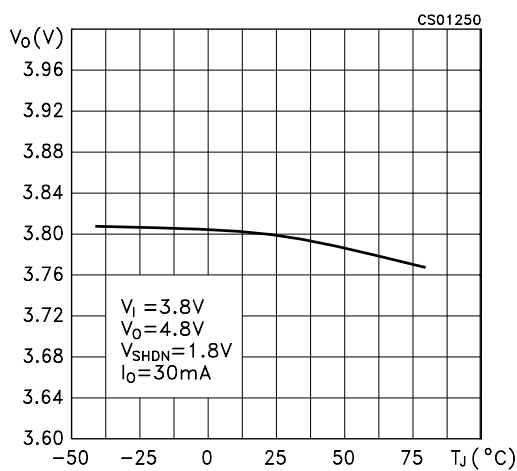

Figure 3 : Line Regulation vs Temperature

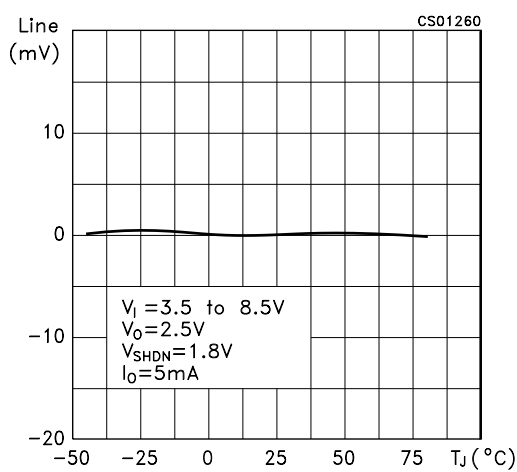

Figure 4 : Load Regulation vs Temperature

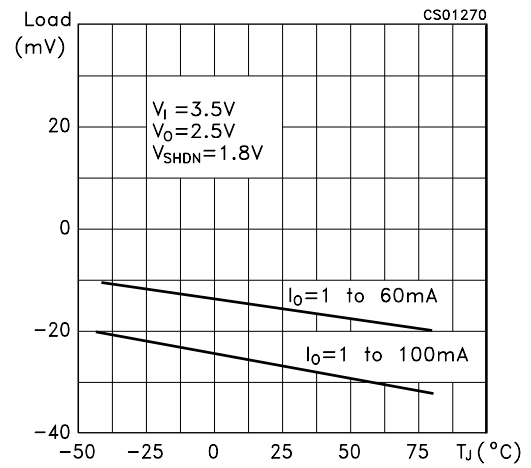

Figure 5 : Dropout Voltage vs Temperature

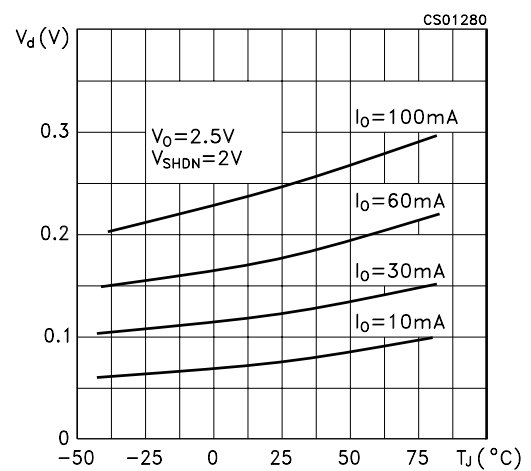

Figure 6 : Short Circuit Current vs Dropout Voltage

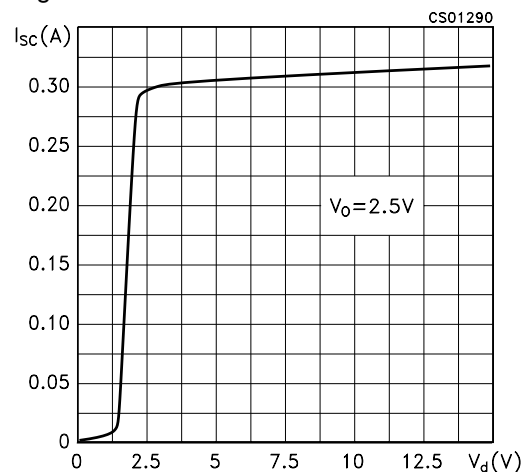

Figure 7 : Output Voltage vs Input Voltage

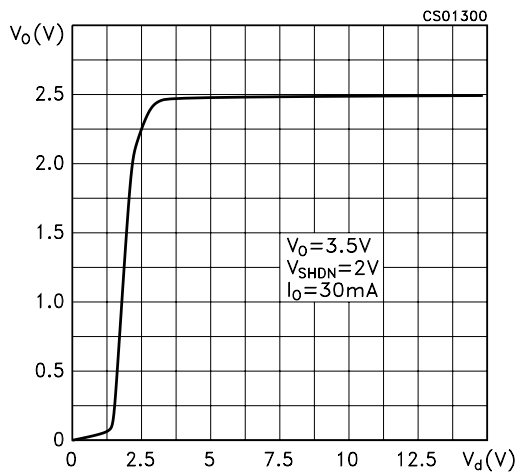

Figure 10 : Supply Voltage Rejection vs Temperature

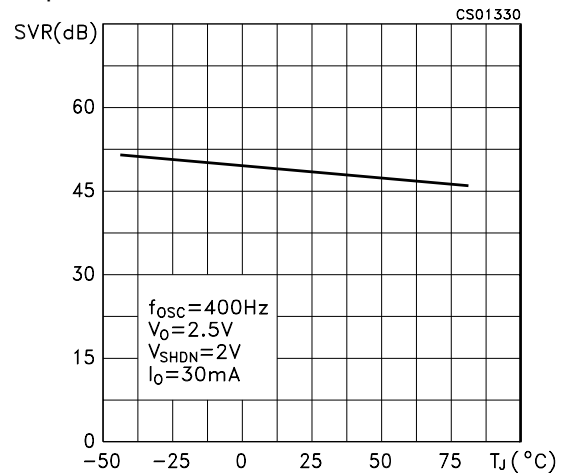

Figure 8 : Shutdown Voltage vs Temperature

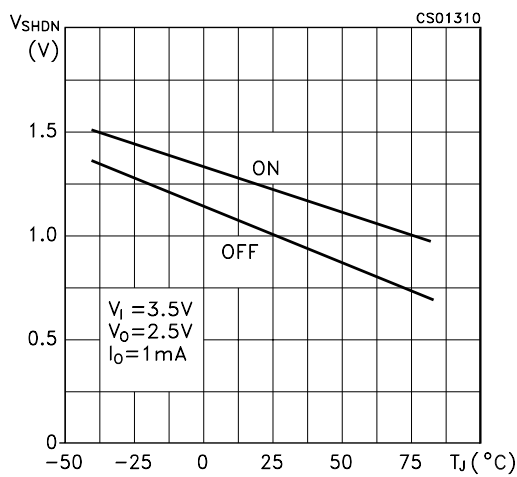

Figure 11 : Supply Voltage Rejection vs Output Current

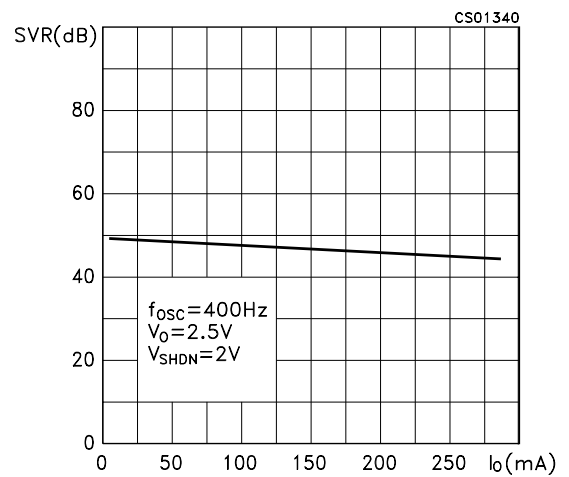

Figure 9 : Shutdown Current vs Shutdown Voltage

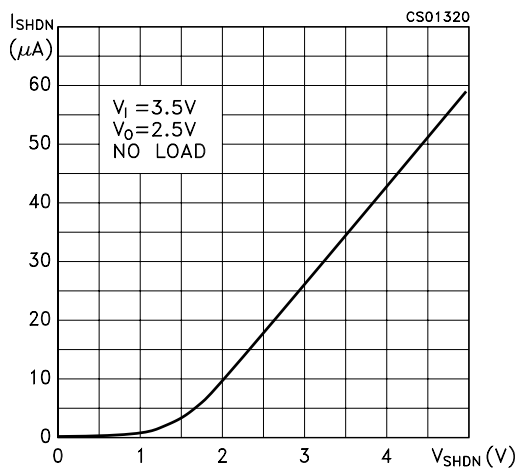

Figure 12 : Supply Voltage Rejection vs Frequency

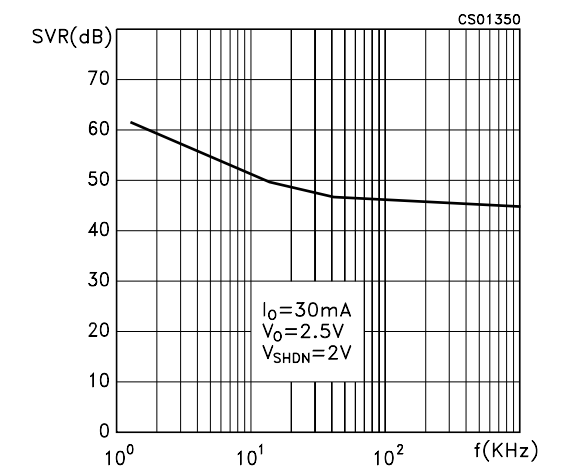

Figure 13 : Supply Voltage Rejection vs Temperature

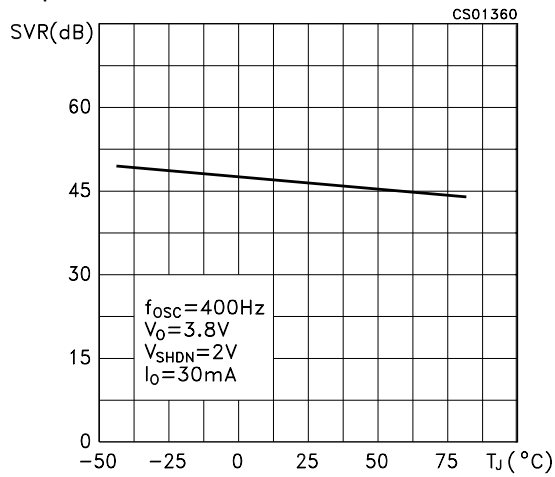

Figure 16 : Quiescent Current vs Shutdown Voltage

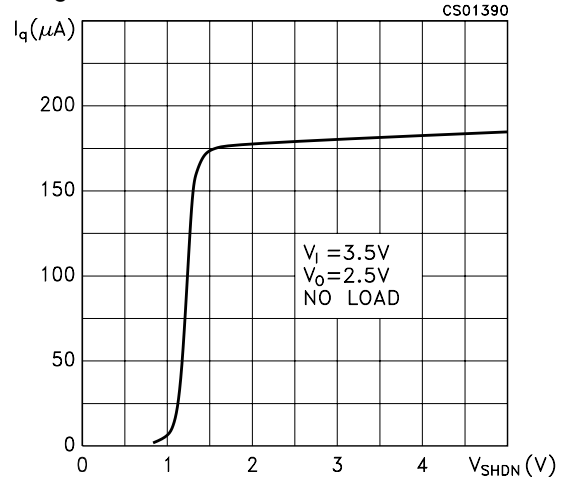

Figure 14 : Quiescent Current vs Temperature

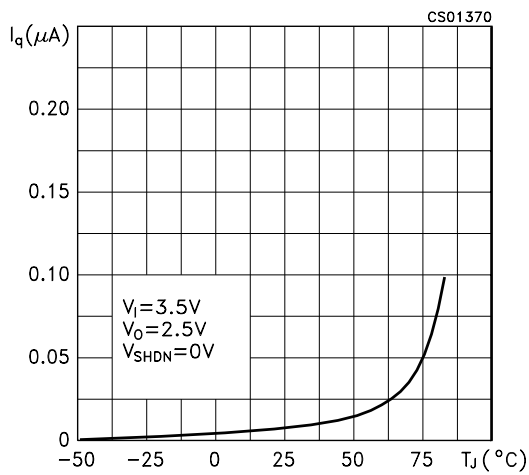

Figure 17 : Quiescent Current vs Output Current

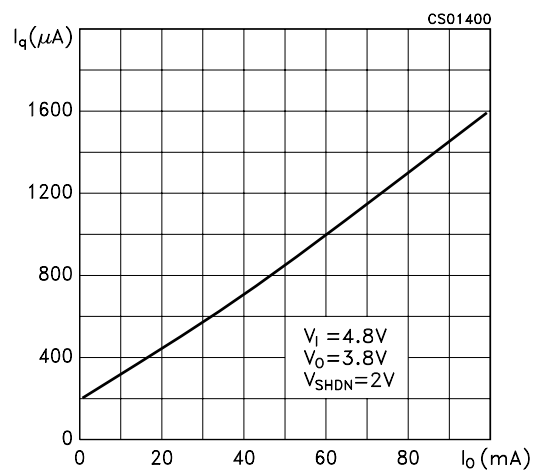

Figure 15 : Quiescent Current vs Input Voltage

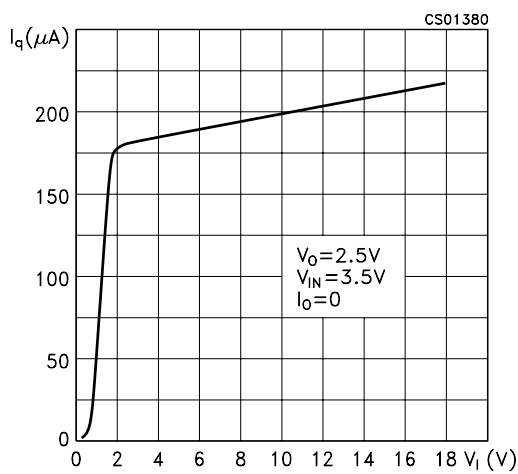

Figure 18 : Reverse Current vs Reverse Voltage

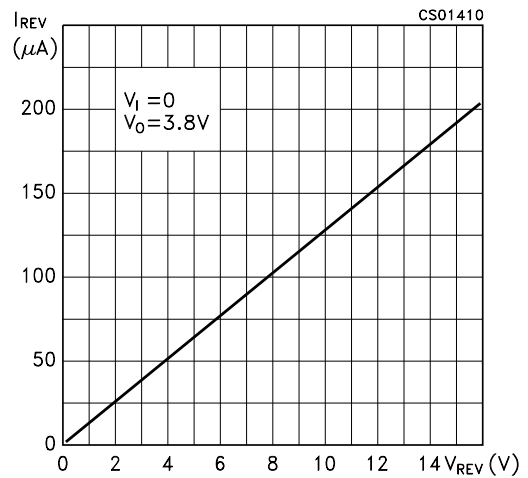

Figure 19 : Stability

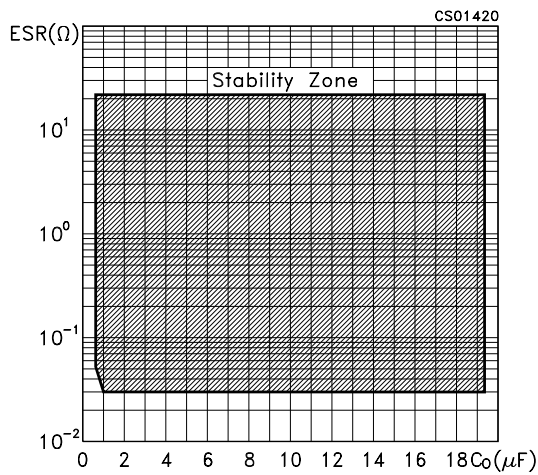

Figure 20 : Spectrum Noise

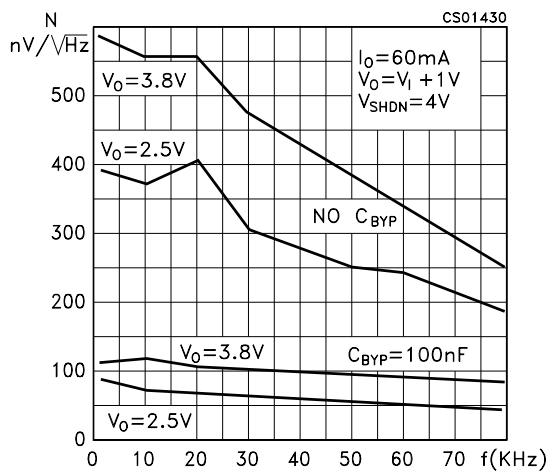

Figure 21 : Start-up Transient

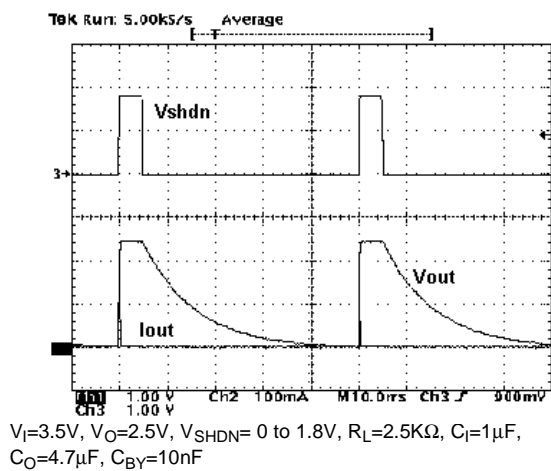

Figure 22 : Start-up Transient

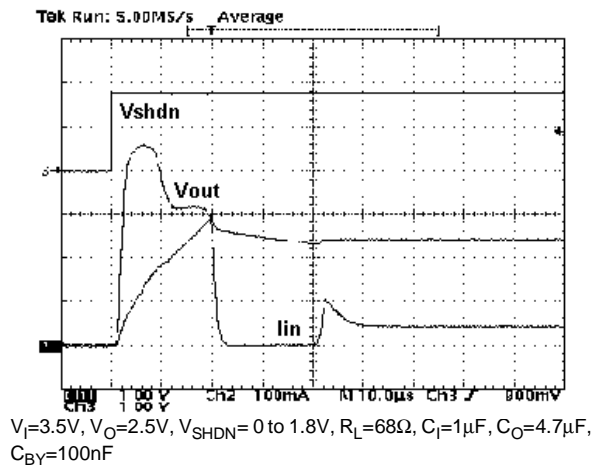

Figure 23 : Line Transient

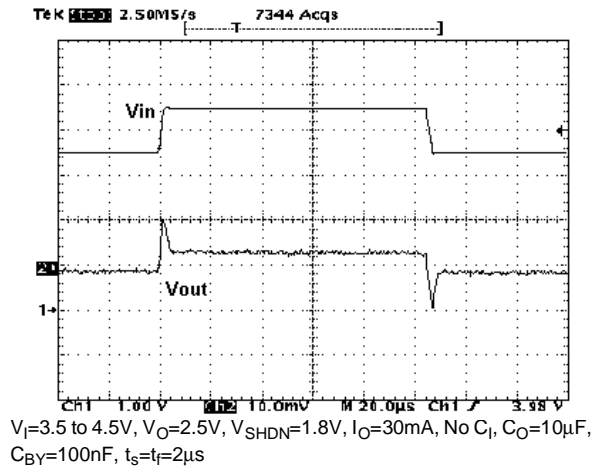

Figure 24 : Line Transient

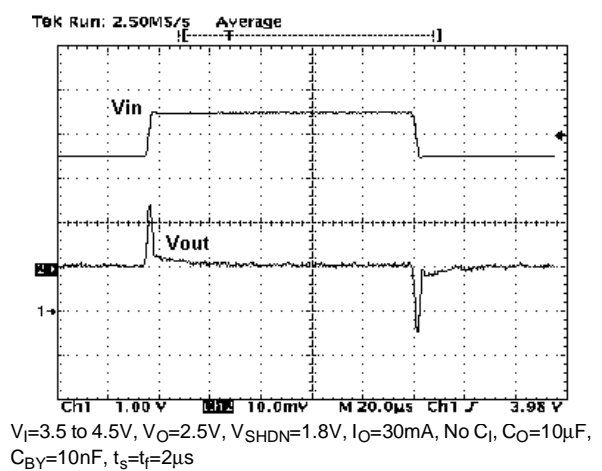
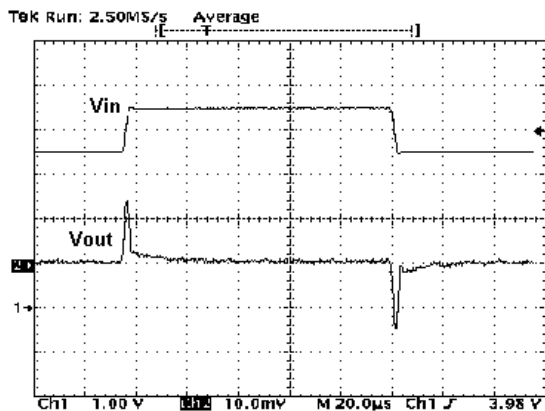
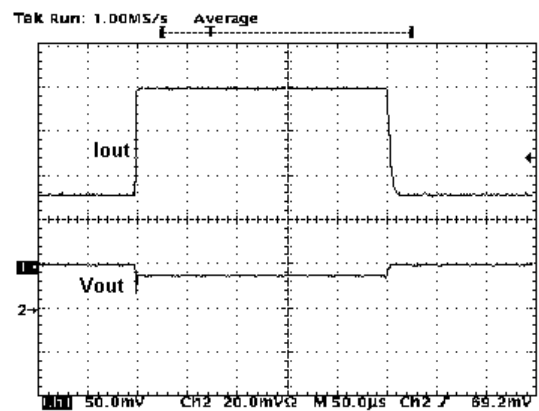

Figure 25 : Line Transient



$V_I=3.5$ to $4.5V$, $V_O=2.5V$, $V_{SHDN}=1.8V$, $I_O=30mA$, No C_I , $C_O=1\mu F$, $C_{BY}=1nF$, $t_s=t_f=2\mu s$

Figure 27 : Load Transient



$V_I=3.5V$, $V_O=2.5V$, $V_{SHDN}=1.8V$, $I_O=50$ to $100mA$, $C_I=1\mu F$, $C_O=10\mu F$, $C_{BY}=100nF$, $t_s=t_f=250ns$

Figure 26 : Load Transient

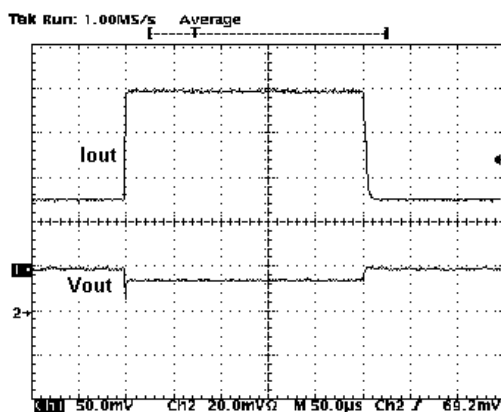

$V_I=3.5V$, $V_O=2.5V$, $V_{SHDN}=1.8V$, $I_O=50$ to $100mA$, $C_I=1\mu F$, $C_O=2.2\mu F$, $C_{BY}=10nF$, $t_s=t_f=250ns$

Figure 28 : Load Transient

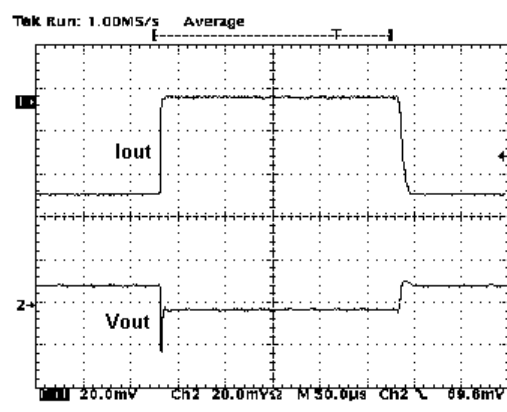

$V_I=4.8V$, $V_O=3.8V$, $V_{SHDN}=1.8V$, $I_O=50$ to $100mA$, $C_I=1\mu F$, $C_O=2.2\mu F$, $C_{BY}=10nF$, $t_s=t_f=250ns$

SOT23-5L MECHANICAL DATA

DIM.	mm.			mils		
	MIN.	TYP	MAX.	MIN.	TYP.	MAX.
A	0.90		1.45	35.4		57.1
A1	0.00		0.10	0.0		3.9
A2	0.90		1.30	35.4		51.2
b	0.35		0.50	13.7		19.7
C	0.09		0.20	3.5		7.8
D	2.80		3.00	110.2		118.1
E	1.50		1.75	59.0		68.8
e		0.95			37.4	
H	2.60		3.00	102.3		118.1
L	0.10		0.60	3.9		23.6

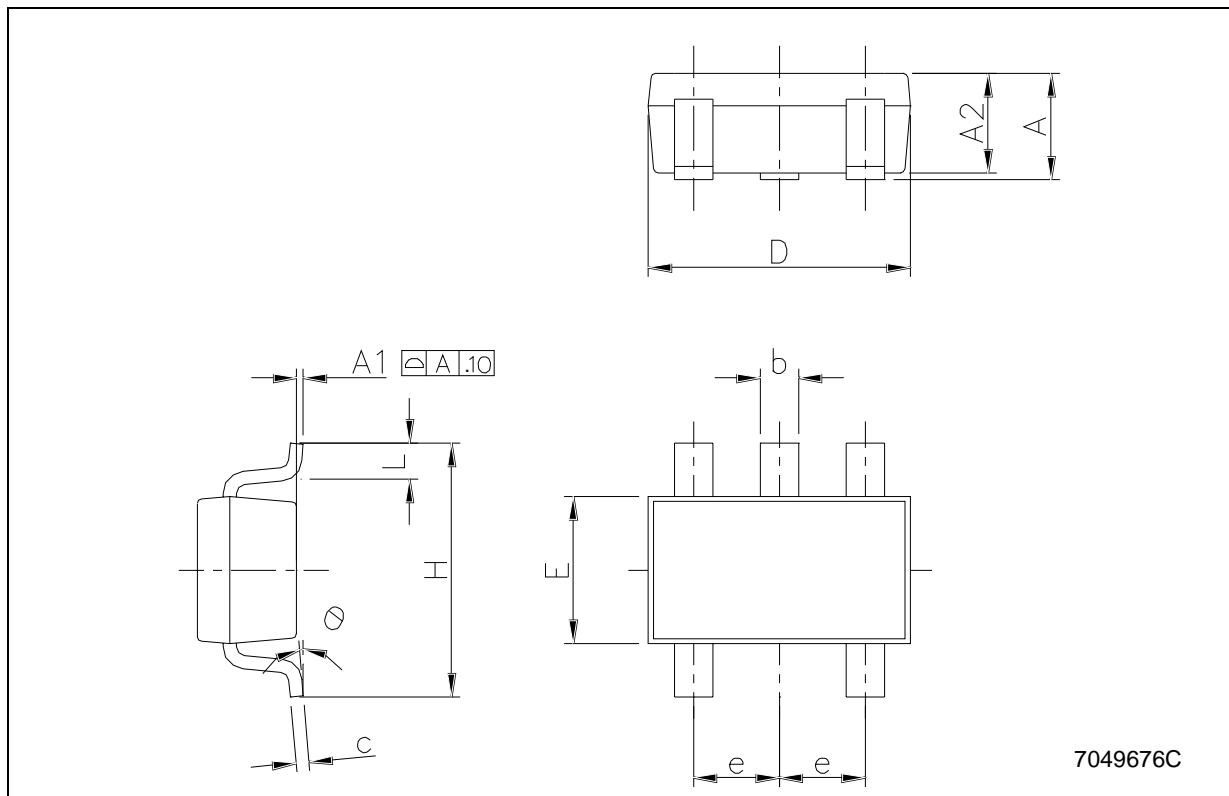

Tape & Reel SOT23-xL MECHANICAL DATA

DIM.	mm.			inch		
	MIN.	TYP	MAX.	MIN.	TYP.	MAX.
A			180			7.086
C	12.8	13.0	13.2	0.504	0.512	0.519
D	20.2			0.795		
N	60			2.362		
T			14.4			0.567
Ao	3.13	3.23	3.33	0.123	0.127	0.131
Bo	3.07	3.17	3.27	0.120	0.124	0.128
Ko	1.27	1.37	1.47	0.050	0.054	0.058
Po	3.9	4.0	4.1	0.153	0.157	0.161
P	3.9	4.0	4.1	0.153	0.157	0.161

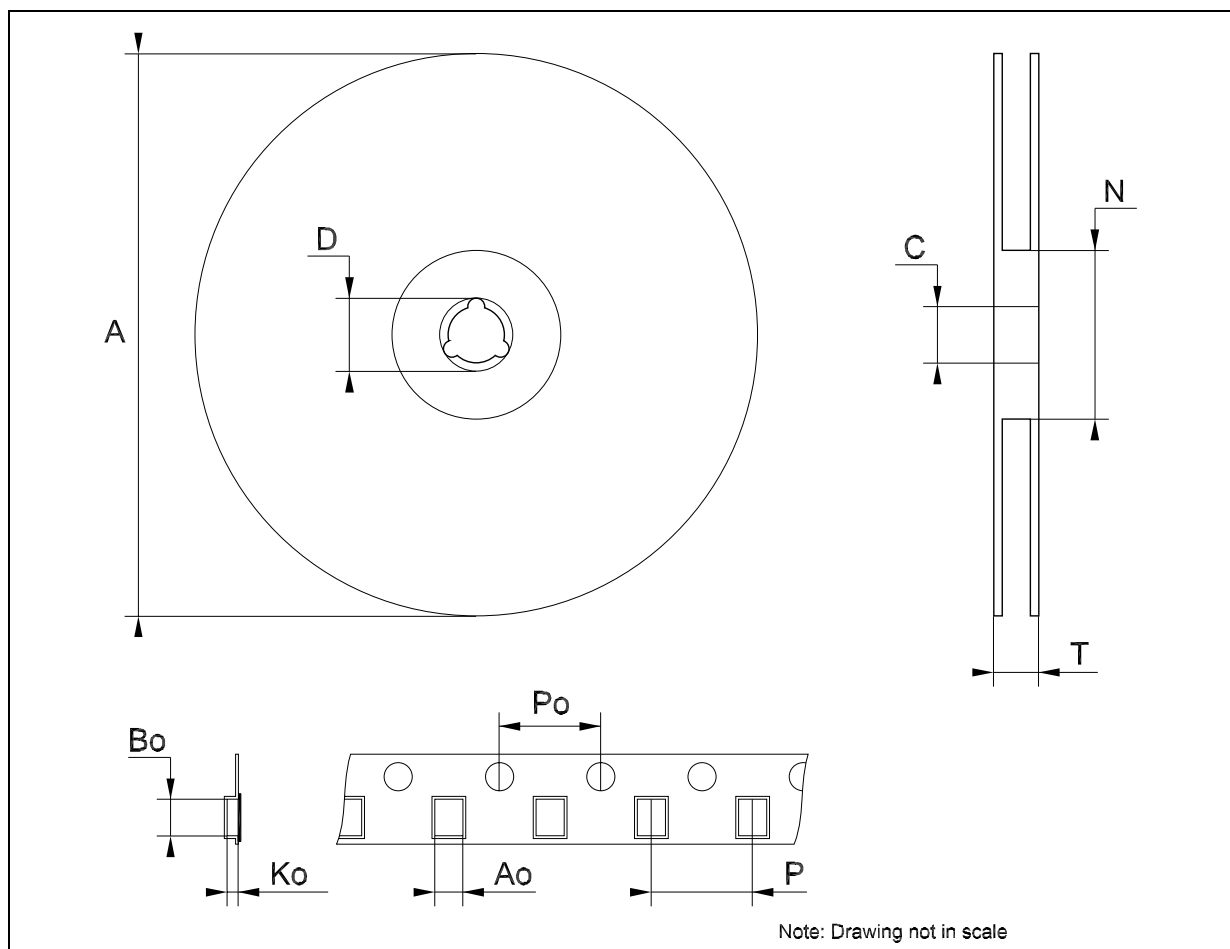

Information furnished is believed to be accurate and reliable. However, STMicroelectronics assumes no responsibility for the consequences of use of such information nor for any infringement of patents or other rights of third parties which may result from its use. No license is granted by implication or otherwise under any patent or patent rights of STMicroelectronics. Specifications mentioned in this publication are subject to change without notice. This publication supersedes and replaces all information previously supplied. STMicroelectronics products are not authorized for use as critical components in life support devices or systems without express written approval of STMicroelectronics.

© The ST logo is a registered trademark of STMicroelectronics

© 2003 STMicroelectronics - Printed in Italy - All Rights Reserved
STMicroelectronics GROUP OF COMPANIES

Australia - Brazil - Canada - China - Finland - France - Germany - Hong Kong - India - Israel - Italy - Japan - Malaysia - Malta - Morocco
Singapore - Spain - Sweden - Switzerland - United Kingdom - United States.

© <http://www.st.com>