

LM6132 Dual/LM6134 Quad Low Power 10 MHz Rail-to-Rail I/O Operational Amplifiers

General Description

The LM6132/34 provides new levels of speed vs power performance in applications where low voltage supplies or power limitations previously made compromise necessary. With only 360 $\mu\text{A}/\text{amp}$ supply current, the 10 MHz gain-bandwidth of this device supports new portable applications where higher power devices unacceptably drain battery life.

The LM6132/34 can be driven by voltages that exceed both power supply rails, thus eliminating concerns over exceeding the common-mode voltage range. The rail-to-rail output swing capability provides the maximum possible dynamic range at the output. This is particularly important when operating on low supply voltages. The LM6132/34 can also drive large capacitive loads without oscillating.

Operating on supplies from 2.7V to over 24V, the LM6132/34 is excellent for a very wide range of applications, from battery operated systems with large bandwidth requirements to high speed instrumentation.

Features

(For 5V Supply, Typ Unless Noted)

- Rail-to-Rail input CMVR -0.25V to 5.25V
- Rail-to-Rail output swing 0.01V to 4.99V
- High gain-bandwidth, 10 MHz at 20 kHz
- Slew rate 12 $\text{V}/\mu\text{s}$
- Low supply current 360 $\mu\text{A}/\text{Amp}$
- Wide supply range 2.7V to over 24V
- CMRR 100 dB
- Gain 100 dB with $R_L = 10\text{k}$
- PSRR 82 dB

Applications

- Battery operated instrumentation
- Instrumentation Amplifiers
- Portable scanners
- Wireless communications
- Flat panel display driver

Connection Diagrams

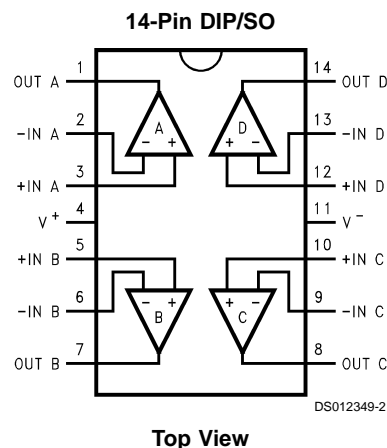
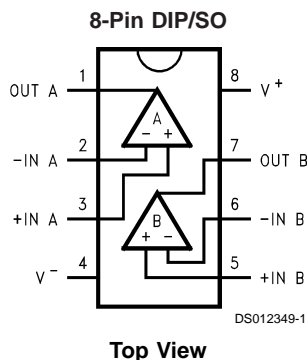

Ordering Information

| Package | Temperature Range Industrial, -40°C to $+85^{\circ}\text{C}$ | NSC Drawing | Transport Media |
|----------------------|---|----------------|--------------------|
| 8-Pin Molded DIP | LM6132AIN, LM6132BIN | N08E | Rails |
| 8-Pin Small Outline | LM6132AIM, LM6132BIM | M08A | Rails |
| | LM6132AIMX, LM6132BIMX | M08A | Tape and Reel |
| 14-Pin Molded DIP | LM6134AIN, LM6134BIN | N14A | Rails |
| 14-Pin Small Outline | LM6134AIM, LM6134BIM | M14A | Rails |
| | LM6134AIMX, LM6134BIMX | M14A | Tape and Reel |

Absolute Maximum Ratings (Note 1)

If Military/Aerospace specified devices are required, please contact the National Semiconductor Sales Office/Distributors for availability and specifications.

| | |
|--|--|
| ESD Tolerance (Note 2) | 2500V |
| Differential Input Voltage | 15V |
| Voltage at Input/Output Pin | (V ⁺)+0.3V, (V ⁻)-0.3V |
| Supply Voltage (V ⁺ -V ⁻) | 35V |
| Current at Input Pin | ±10 mA |
| Current at Output Pin (Note 3) | ±25 mA |
| Current at Power Supply Pin | 50 mA |
| Lead Temp. (soldering, 10 sec.) | 260°C |
| Storage Temperature Range | -65°C to +150°C |

Junction Temperature (Note 4)

150°C

Operating Ratings(Note 1)

| | |
|---------------------------------------|--------------------------------|
| Supply Voltage | 1.8V ≤ V _S ≤ 24V |
| Junction Temperature Range | |
| LM6132, LM6134 | -40°C ≤ T _J ≤ +85°C |
| Thermal resistance (θ _{JA}) | |
| N Package, 8-pin Molded DIP | 115°C/W |
| M Package, 8-pin Surface Mount | 193°C/W |
| N Package, 14-pin Molded DIP | 81°C/W |
| M Package, 14-pin Surface Mount | 126°C/W |

5.0V DC Electrical Characteristics

Unless otherwise specified, all limits guaranteed for T_J = 25°C, V⁺ = 5.0V, V⁻ = 0V, V_{CM} = V_O = V⁺/2 and R_L > 1 MΩ to V_S/2. **Boldface** limits apply at the temperature extremes

| Symbol | Parameter | Conditions | Typ (Note 5) | LM6134AI LM6132AI Limit (Note 6) | LM6134BI LM6132BI Limit (Note 6) | Units |
|-------------------|--|-------------------------------|-----------------|---|---|-------------|
| V _{OS} | Input Offset Voltage | | 0.25 | 2 4 | 6 8 | mV max |
| TCV _{OS} | Input Offset Voltage Average Drift | | 5 | | | μV/C |
| I _B | Input Bias Current | 0V ≤ V _{CM} ≤ 5V | 110 | 140 300 | 180 350 | nA max |
| I _{OS} | Input Offset Current | | 3.4 | 30 50 | 30 50 | nA max |
| R _{IN} | Input Resistance, CM | | 104 | | | MΩ |
| CMRR | Common Mode Rejection Ratio | 0V ≤ V _{CM} ≤ 4V | 100 | 75 70 | 75 70 | dB min |
| | | 0V ≤ V _{CM} ≤ 5V | 80 | 60 55 | 60 55 | |
| PSRR | Power Supply Rejection Ratio | ±2.5V ≤ V _S ≤ ±12V | 82 | 78 75 | 78 75 | dB min |
| V _{CM} | Input Common-Mode Voltage Range | | -0.25 | 0 | 0 | V |
| | | | 5.25 | 5.0 | 5.0 | |
| A _V | Large Signal Voltage Gain | R _L = 10k | 100 | 25 8 | 15 6 | V/mV min |
| V _O | Output Swing | 100k Load | 4.992 | 4.98 4.93 | 4.98 4.93 | V min |
| | | | 0.007 | 0.017 0.019 | 0.017 0.019 | V max |
| | | 10k Load | 4.952 | 4.94 4.85 | 4.94 4.85 | V min |
| | | | 0.032 | 0.07 0.09 | 0.07 0.09 | V max |
| | | 5k Load | 4.923 | 4.90 4.85 | 4.90 4.85 | V min |
| | | | 0.051 | 0.095 0.12 | 0.095 0.12 | V max |
| I _{SC} | Output Short Circuit Current LM6132 | Sourcing | 4 | 2 2 | 2 1 | mA min |
| | | Sinking | 3.5 | 1.8 1.8 | 1.8 1 | mA min |

5.0V DC Electrical Characteristics (Continued)

Unless otherwise specified, all limits guaranteed for $T_J = 25^\circ\text{C}$, $V^+ = 5.0\text{V}$, $V^- = 0\text{V}$, $V_{\text{CM}} = V_O = V^+/2$ and $R_L > 1\text{ M}\Omega$ to $V_S/2$. **Boldface** limits apply at the temperature extremes

| Symbol | Parameter | Conditions | Typ (Note 5) | LM6134AI LM6132AI Limit (Note 6) | LM6134BI LM6132BI Limit (Note 6) | Units |
|-----------------|--|---------------|-----------------|---|---|----------------------|
| I_{SC} | Output Short Circuit Current LM6134 | Sourcing | 3 | 2 1.6 | 2 1 | mA min |
| | | Sinking | 3.5 | 1.8 1.3 | 1.8 1 | mA min |
| I_S | Supply Current | Per Amplifier | 360 | 400 450 | 400 450 | μA max |

5.0V AC Electrical Characteristics

Unless otherwise specified, all limits guaranteed for $T_J = 25^\circ\text{C}$, $V^+ = 5.0\text{V}$, $V^- = 0\text{V}$, $V_{\text{CM}} = V_O = V^+/2$ and $R_L > 1\text{ M}\Omega$ to $V_S/2$. **Boldface** limits apply at the temperature extremes

| Symbol | Parameter | Conditions | Typ (Note 5) | LM6134AI LM6132AI Limit (Note 6) | LM6134BI LM6132BI Limit (Note 6) | Units |
|------------|------------------------------|---|-----------------|---|---|--------------------------------------|
| SR | Slew Rate | $\pm 4\text{V} @ V_S = \pm 6\text{V}$ $R_S < 1\text{ k}\Omega$ | 14 | 8 7 | 8 7 | $\text{V}/\mu\text{s}$ min |
| GBW | Gain-Bandwidth Product | $f = 20\text{ kHz}$ | 10 | 7.4 7 | 7.4 7 | MHz min |
| θ_m | Phase Margin | $R_L = 10\text{k}$ | 33 | | | deg |
| G_m | Gain Margin | $R_L = 10\text{k}$ | 10 | | | dB |
| e_n | Input Referred Voltage Noise | $f = 1\text{ kHz}$ | 27 | | | $\frac{\text{nV}}{\sqrt{\text{Hz}}}$ |
| i_n | Input Referred Current Noise | $f = 1\text{ kHz}$ | 0.18 | | | $\frac{\text{pA}}{\sqrt{\text{Hz}}}$ |

2.7V DC Electrical Characteristics

Unless otherwise specified, all limits guaranteed for $T_J = 25^\circ\text{C}$, $V^+ = 2.7\text{V}$, $V^- = 0\text{V}$, $V_{\text{CM}} = V_O = V^+/2$ and $R_L > 1\text{ M}\Omega$ to $V_S/2$. **Boldface** limits apply at the temperature extreme

| Symbol | Parameter | Conditions | Typ (Note 5) | LM6134AI LM6132AI Limit (Note 6) | LM6134BI LM6132BI Limit (Note 6) | Units |
|-----------------|---------------------------------|---|-----------------|---|---|------------------|
| V_{OS} | Input Offset Voltage | | 0.12 | 2 8 | 6 12 | mV max |
| I_B | Input Bias Current | $0\text{V} \leq V_{\text{CM}} \leq 2.7\text{V}$ | 90 | | | nA |
| I_{OS} | Input Offset Current | | 2.8 | | | nA |
| R_{IN} | Input Resistance | | 134 | | | $\text{M}\Omega$ |
| CMRR | Common Mode Rejection Ratio | $0\text{V} \leq V_{\text{CM}} \leq 2.7\text{V}$ | 82 | | | dB |
| PSRR | Power Supply Rejection Ratio | $\pm 1.35\text{V} \leq V_S \leq \pm 12\text{V}$ | 80 | | | dB |
| V_{CM} | Input Common-Mode Voltage Range | | | 2.7 0 | 2.7 0 | V |
| A_V | Large Signal Voltage Gain | $R_L = 10\text{k}$ | 100 | | | V/mV |
| V_O | Output Swing | $R_L = 100\text{k}$ | 0.03 | 0.08 0.112 | 0.08 0.112 | V max |
| | | | 2.66 | 2.65 2.25 | 2.65 2.25 | V min |
| I_S | Supply Current | Per Amplifier | 330 | | | μA |

2.7V AC Electrical Characteristics

Unless otherwise specified, all limits guaranteed for $T_J = 25^\circ\text{C}$, $V^+ = 2.7\text{V}$, $V^- = 0\text{V}$, $V_{\text{CM}} = V_O = V^+/2$ and $R_L > 1\text{ M}\Omega$ to $V_S/2$.

| Symbol | Parameter | Conditions | Typ (Note 5) | LM6134AI LM6132AI Limit (Note 6) | LM6134BI LM6132BI Limit (Note 6) | Units |
|------------|------------------------|--|-----------------|---|---|-------|
| GBW | Gain-Bandwidth Product | $R_L = 10\text{k}$, $f = 20\text{ kHz}$ | 7 | | | MHz |
| θ_m | Phase Margin | $R_L = 10\text{k}$ | 23 | | | deg |
| G_m | Gain Margin | | 12 | | | dB |

24V DC Electrical Characteristics

Unless otherwise specified, all limits guaranteed for $T_J = 25^\circ\text{C}$, $V^+ = 24\text{V}$, $V^- = 0\text{V}$, $V_{\text{CM}} = V_O = V^+/2$ and $R_L > 1\text{ M}\Omega$ to $V_S/2$. **Boldface** limits apply at the temperature extreme

| Symbol | Parameter | Conditions | Typ (Note 5) | LM6134AI LM6132AI Limit (Note 6) | LM6134BI LM6132BI Limit (Note 6) | Units |
|-----------------|---------------------------------|--|-----------------|---|---|----------------------|
| V_{OS} | Input Offset Voltage | | 1.7 | 3 5 | 7 9 | mV max |
| I_B | Input Bias Current | $0\text{V} \leq V_{\text{CM}} \leq 24\text{V}$ | 125 | | | nA |
| I_{OS} | Input Offset Current | | 4.8 | | | nA |
| R_{IN} | Input Resistance | | 210 | | | M Ω |
| CMRR | Common Mode Rejection Ratio | $0\text{V} \leq V_{\text{CM}} \leq 24\text{V}$ | 80 | | | dB |
| PSRR | Power Supply Rejection Ratio | $2.7\text{V} \leq V_S \leq 24\text{V}$ | 82 | | | dB |
| V_{CM} | Input Common-Mode Voltage Range | | -0.25 | 0 | 0 | V min |
| | | | 24.25 | 24 | 24 | V max |
| A_V | Large Signal Voltage Gain | $R_L = 10\text{k}$ | 102 | | | V/mV |
| V_O | Output Swing | $R_L = 10\text{k}$ | 0.075 | 0.15 | 0.15 | V max |
| | | | 23.86 | 23.8 | 23.8 | V min |
| I_S | Supply Current | Per Amplifier | 390 | 450 490 | 450 490 | μA max |

24V AC Electrical Characteristics

Unless otherwise specified, all limits guaranteed for $T_J = 25^\circ\text{C}$, $V^+ = 24\text{V}$, $V^- = 0\text{V}$, $V_{\text{CM}} = V_O = V^+/2$ and $R_L > 1\text{ M}\Omega$ to $V_S/2$.

| Symbol | Parameter | Conditions | Typ (Note 5) | LM6134AI LM6132AI Limit (Note 6) | LM6134BI LM6132BI Limit (Note 6) | Units |
|------------|-------------------------------------|---|-----------------|---|---|-------|
| GBW | Gain-Bandwidth Product | $R_L = 10\text{k}$, $f = 20\text{ kHz}$ | 11 | | | MHz |
| θ_m | Phase Margin | $R_L = 10\text{k}$ | 23 | | | deg |
| G_m | Gain Margin | $R_L = 10\text{k}$ | 12 | | | dB |
| THD + N | Total Harmonic Distortion and Noise | $A_V = +1$, $V_O = 20\text{V}_{\text{P-P}}$ $f = 10\text{ kHz}$ | 0.0015 | | | % |

Note 1: Absolute Maximum Ratings indicate limits beyond which damage to the device may occur. Operating Ratings indicate conditions for which the device is intended to be functional, but specific performance is not guaranteed. For guaranteed specifications and the test conditions, see the Electrical characteristics.

Note 2: Human body model, 1.5 k Ω in series with 100 pF.

Note 3: Applies to both single-supply and split-supply operation. Continuous short circuit operation at elevated ambient temperature can result in exceeding the maximum allowed junction temperature of 150°C.

Note 4: The maximum power dissipation is a function of $T_{\text{J(max)}}$, θ_{JA} , and T_A . The maximum allowable power dissipation at any ambient temperature is $P_D = (T_{\text{J(max)}} - T_A)/\theta_{\text{JA}}$. All numbers apply for packages soldered directly into a PC board.

Note 5: Typical Values represent the most likely parametric norm.

Note 6: All limits are guaranteed by testing or statistical analysis.

Typical Performance Characteristics $T_A = 25^\circ\text{C}$, $R_L = 10\text{ k}\Omega$ unless otherwise specified

Supply Current vs Supply Voltage

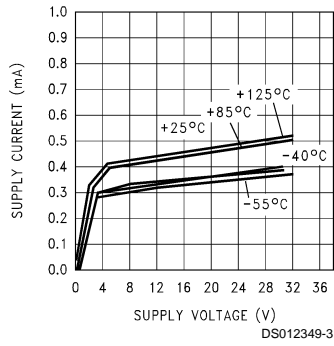

Offset Voltage vs Supply Voltage

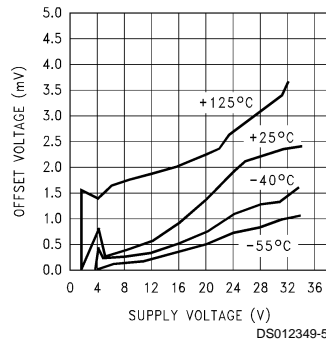

dV_{OS} vs V_{CM}

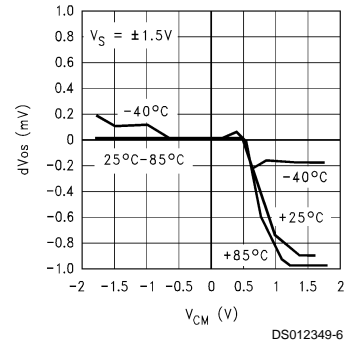

dV_{OS} vs V_{CM}

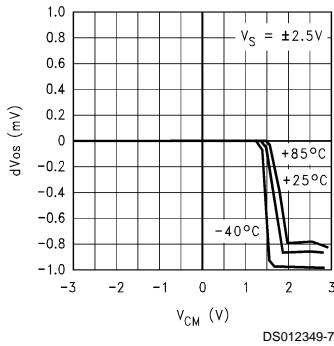

dV_{OS} vs V_{CM}

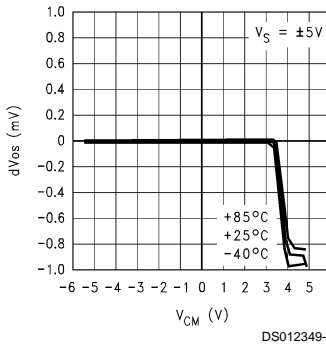

I_{bias} vs V_{CM}

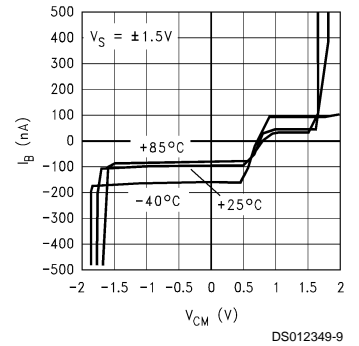

I_{bias} vs V_{CM}

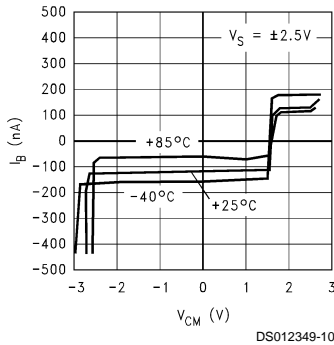

I_{bias} vs V_{CM}

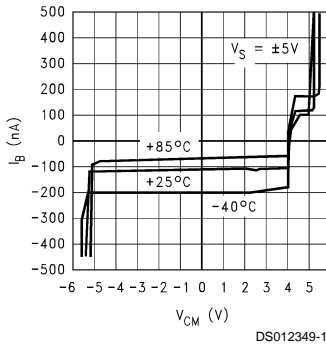

Input Bias Current vs Supply Voltage

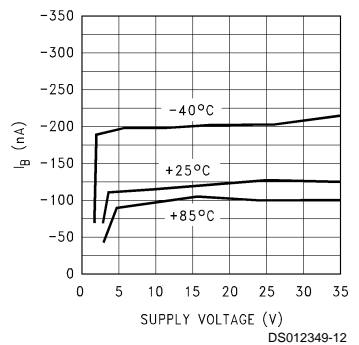

Neg PSRR vs Frequency

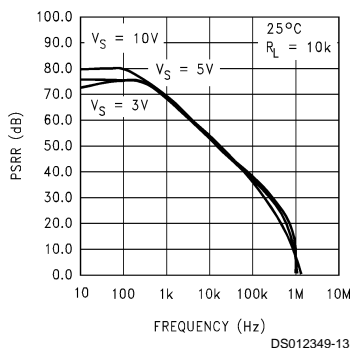

Pos PSRR vs Frequency

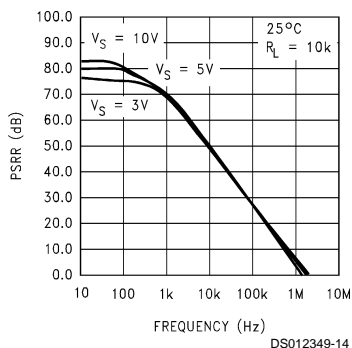

dV_{OS} vs Output Voltage

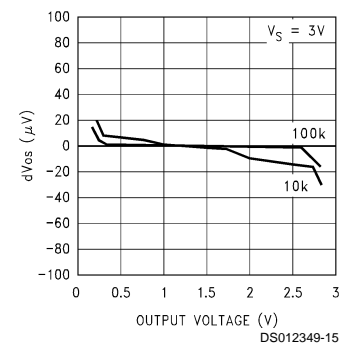

Typical Performance Characteristics $T_A = 25^\circ\text{C}$, $R_L = 10\text{ k}\Omega$ unless otherwise specified (Continued)

dV_{OS} vs Output Voltage

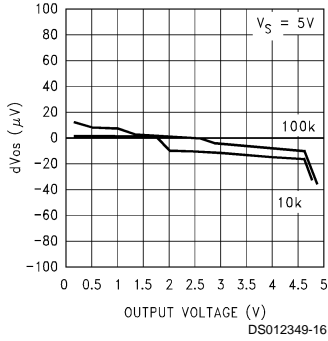

dV_{OS} vs Output Voltage

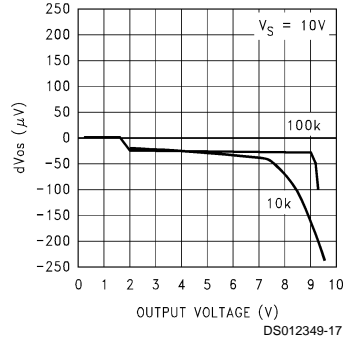

CMRR vs Frequency

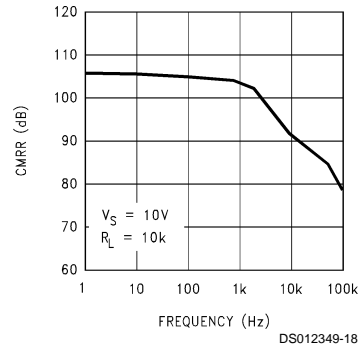

Output Voltage vs Sinking Current

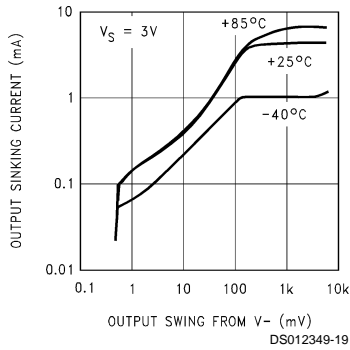

Output Voltage vs Sinking Current

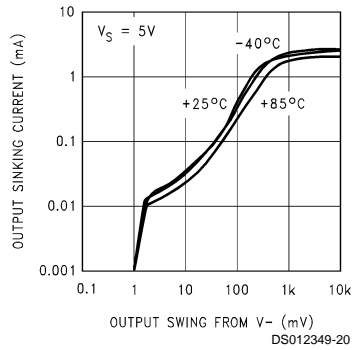

Output Voltage vs Sinking Current

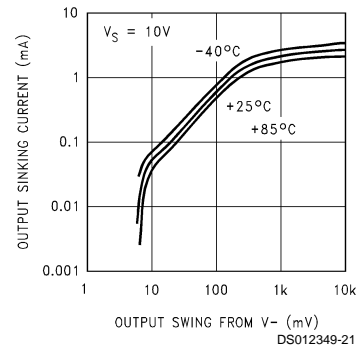

Output Voltage vs Sourcing Current

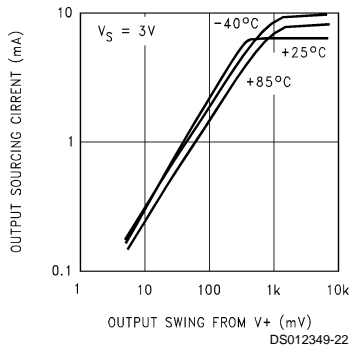

Output Voltage vs Sourcing Current

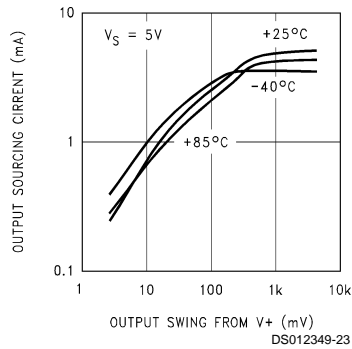

Output Voltage vs Sourcing Current

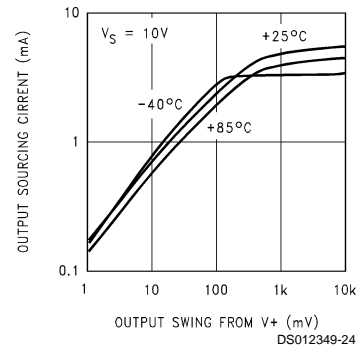

Typical Performance Characteristics $T_A = 25^\circ\text{C}$, $R_L = 10\text{ k}\Omega$ unless otherwise specified (Continued)

Noise Voltage vs Frequency

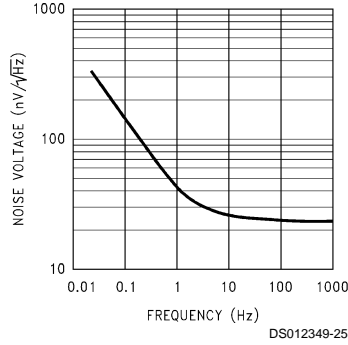

Noise Current vs Frequency

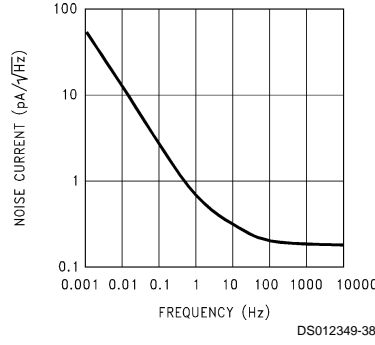

NF vs Source Resistance

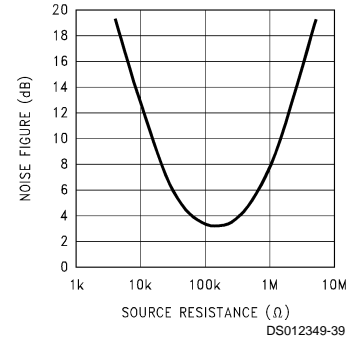

Gain and Phase vs Frequency

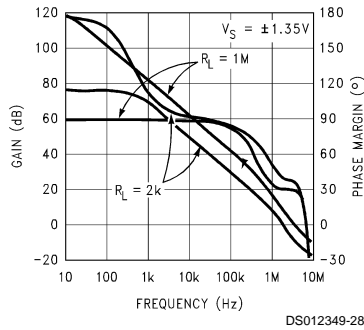

Gain and Phase vs Frequency

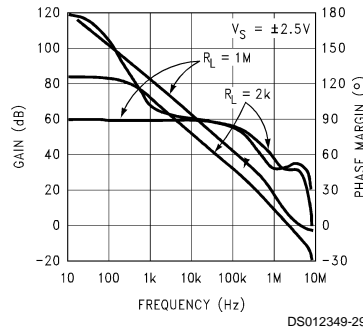

Gain and Phase vs Frequency

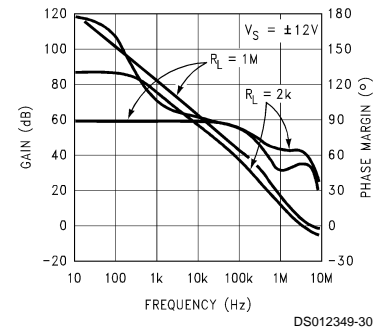

GBW vs Supply Voltage at 20 kHz

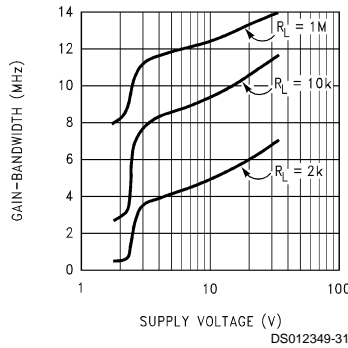

LM6132/34 Application Hints

The LM6132 brings a new level of ease of use to opamp system design.

With greater than rail-to-rail input voltage range concern over exceeding the common-mode voltage range is eliminated.

Rail-to-rail output swing provides the maximum possible dynamic range at the output. This is particularly important when operating on low supply voltages.

The high gain-bandwidth with low supply current opens new battery powered applications, where high power consumption, previously reduced battery life to unacceptable levels.

To take advantage of these features, some ideas should be kept in mind.

ENHANCED SLEW RATE

Unlike most bipolar opamps, the unique phase reversal prevention/speed-up circuit in the input stage eliminates phase reversal and allows the slew rate to be very much a function of the input signal amplitude.

Figure 2 shows how excess input signal is routed around the input collector-base junctions directly to the current mirrors.

The LM6132/34 input stage converts the input voltage change to a current change. This current change drives the current mirrors through the collectors of Q1–Q2, Q3–Q4 when the input levels are normal.

LM6132/34 Application Hints

(Continued)

If the input signal exceeds the slew rate of the input stage and the differential input voltage rises above a diode drop, the excess signal bypasses the normal input transistors, (Q1–Q4), and is routed in correct phase through the two additional transistors, (Q5, Q6), directly into the current mirrors.

This rerouting of excess signal allows the slew-rate to increase by a factor of 10 to 1 or more. (See *Figure 1*.)

As the overdrive increases, the opamp reacts better than a conventional opamp. Large fast pulses will raise the slew-rate to around 25V to 30V/ μ s.

Slew Rate vs Differential V_{IN}
 $V_S = \pm 12V$

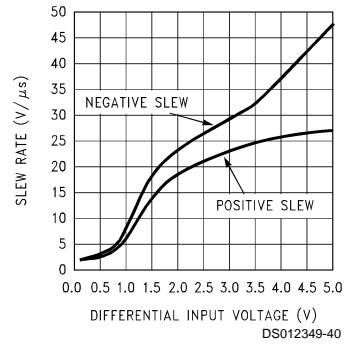

FIGURE 1.

This effect is most noticeable at higher supply voltages and lower gains where incoming signals are likely to be large.

This speed-up action adds stability to the system when driving large capacitive loads.

DRIVING CAPACITIVE LOADS

Capacitive loads decrease the phase margin of all opamps. This is caused by the output resistance of the amplifier and the load capacitance forming an R-C phase lag network. This can lead to overshoot, ringing and oscillation. Slew rate limiting can also cause additional lag. Most opamps with a fixed maximum slew-rate will lag further and further behind when driving capacitive loads even though the differential input voltage raises. With the LM6132, the lag causes the slew rate to raise. The increased slew-rate keeps the output following the input much better. This effectively reduces phase lag. After the output has caught up with the input, the differential input voltage drops down and the amplifier settles rapidly.

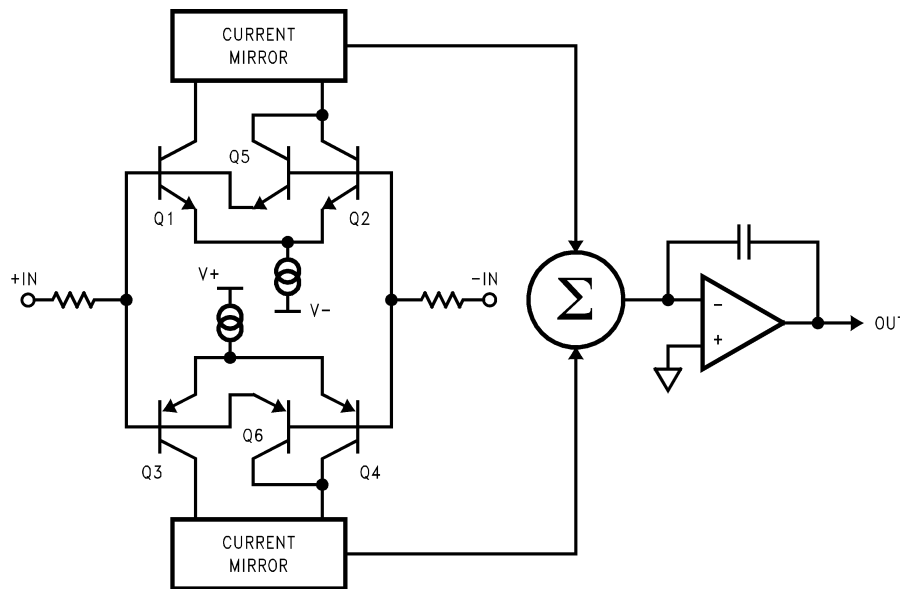

FIGURE 2.

DS012349-36

These features allow the LM6132 to drive capacitive loads as large as 500 pF at unity gain and not oscillate. The scope photos (*Figure 3* and *Figure 4*) above show the LM6132 driv-

ing a 500 pF load. In *Figure 3*, the lower trace is with no capacitive load and the upper trace is with a 500 pF load. Here we are operating on $\pm 12V$ supplies with a 20 Vp-p pulse. Ex-

LM6132/34 Application Hints

(Continued)

cellent response is obtained with a C_f of 39 pF. In *Figure 4*, the supplies have been reduced to $\pm 2.5V$, the pulse is 4 Vp-p and C_f is 39 pF. The best value for the compensation capacitor should be established after the board layout is finished because the value is dependent on board stray capacity, the value of the feedback resistor, the closed loop gain and, to some extent, the supply voltage.

Another effect that is common to all opamps is the phase shift caused by the feedback resistor and the input capacitance. This phase shift also reduces phase margin. This effect is taken care of at the same time as the effect of the capacitive load when the capacitor is placed across the feedback resistor.

The circuit shown in *Figure 5* was used for these scope photos.

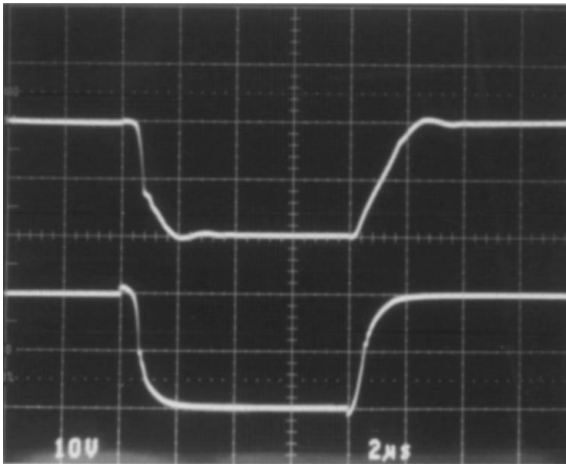

DS012349-45

FIGURE 3.

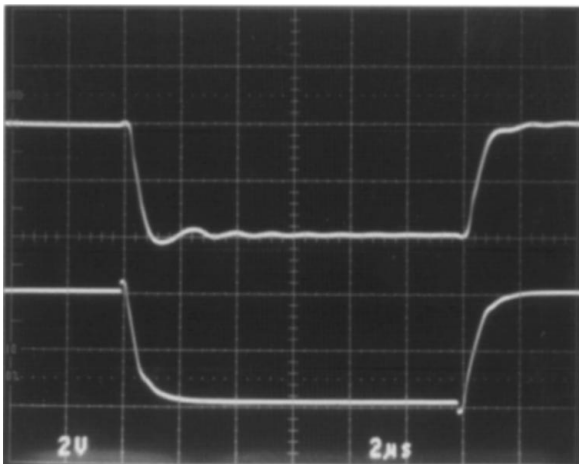

DS012349-42

FIGURE 4.

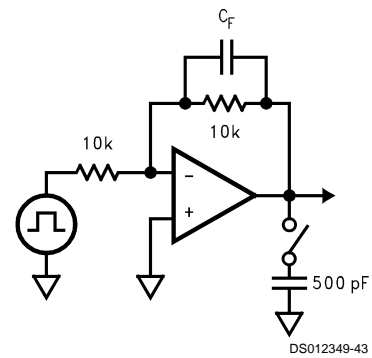

DS012349-43

FIGURE 5.

Figure 6 shows a method for compensating for load capacitance (C_o) effects by adding both an isolation resistor R_o at the output and a feedback capacitor C_f directly between the output and the inverting input pin. Feedback capacitor C_f compensates for the pole introduced by R_o and C_o , minimizing ringing in the output waveform while the feedback resistor R_f compensates for dc inaccuracies introduced by R_o . Depending on the size of the load capacitance, the value of R_o is typically chosen to be between 100 Ω to 1 k Ω .

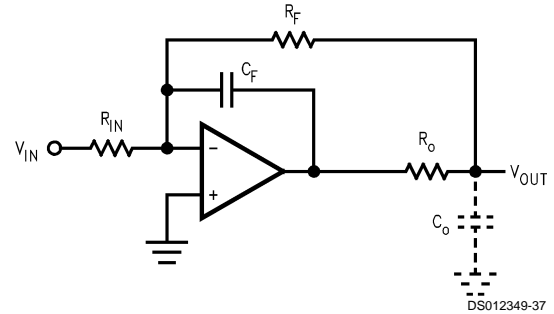

DS012349-37

FIGURE 6.

Typical Applications

3 OPAMP INSTRUMENTATION AMP WITH RAIL-TO-RAIL INPUT AND OUTPUT

Using the LM6134, a 3 opamp instrumentation amplifier with rail-to-rail inputs and rail to rail output can be made. These features make these instrumentation amplifiers ideal for single supply systems.

Some manufacturers use a precision voltage divider array of 5 resistors to divide the common-mode voltage to get an input range of rail-to-rail or greater. The problem with this method is that it also divides the signal, so to even get unity gain, the amplifier must be run at high closed loop gains. This raises the noise and drift by the internal gain factor and lowers the input impedance. Any mismatch in these precision resistors reduces the CMR as well. Using the LM6134, all of these problems are eliminated.

In this example, amplifiers A and B act as buffers to the differential stage (*Figure 7*). These buffers assure that the input impedance is over 100 M Ω and they eliminate the requirement for precision matched resistors in the input stage. They also assure that the difference amp is driven from a voltage source. This is necessary to maintain the CMR set by the matching of R1–R2 with R3–R4.

Physical Dimensions inches (millimeters) unless otherwise noted

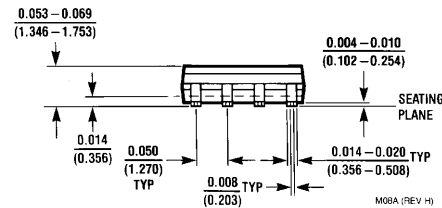
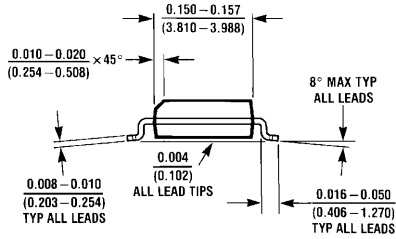
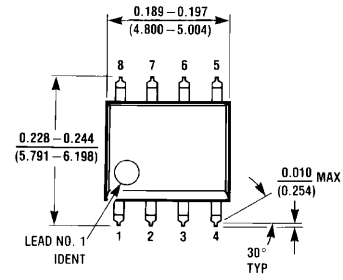

8-Lead (0.150" Wide) Molded Small Outline Package, JEDEC
Order Number LM6132AIM, LM6132BIM, LM6132AIMX or LM6132BIMX
NS Package Number M08A

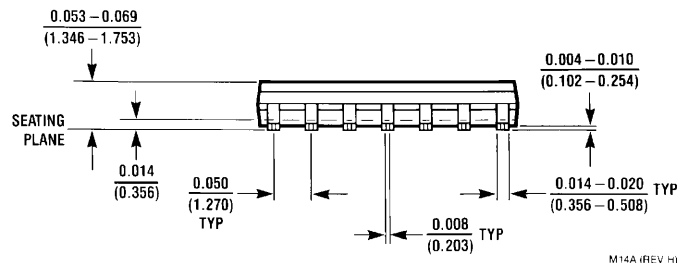
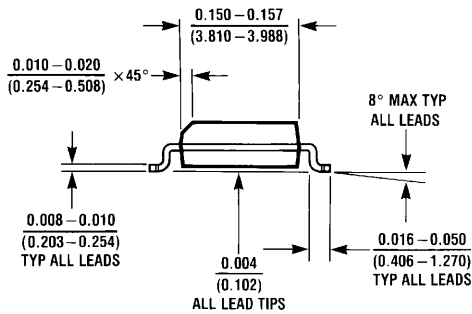
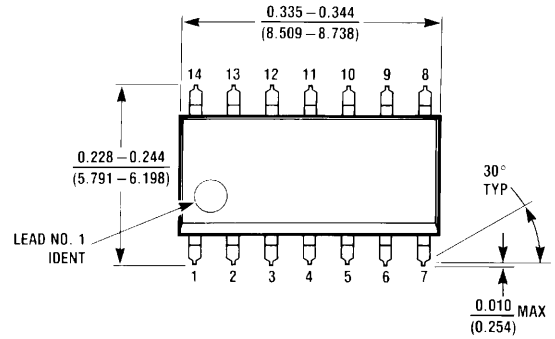

14-Lead (0.300" Wide) Molded Small Outline Package, JEDEC
Order Number LM6134AIM, LM6134BIM, LM6134AIMX or LM6134BIMX
NS Package Number M14A

Physical Dimensions inches (millimeters) unless otherwise noted (Continued)

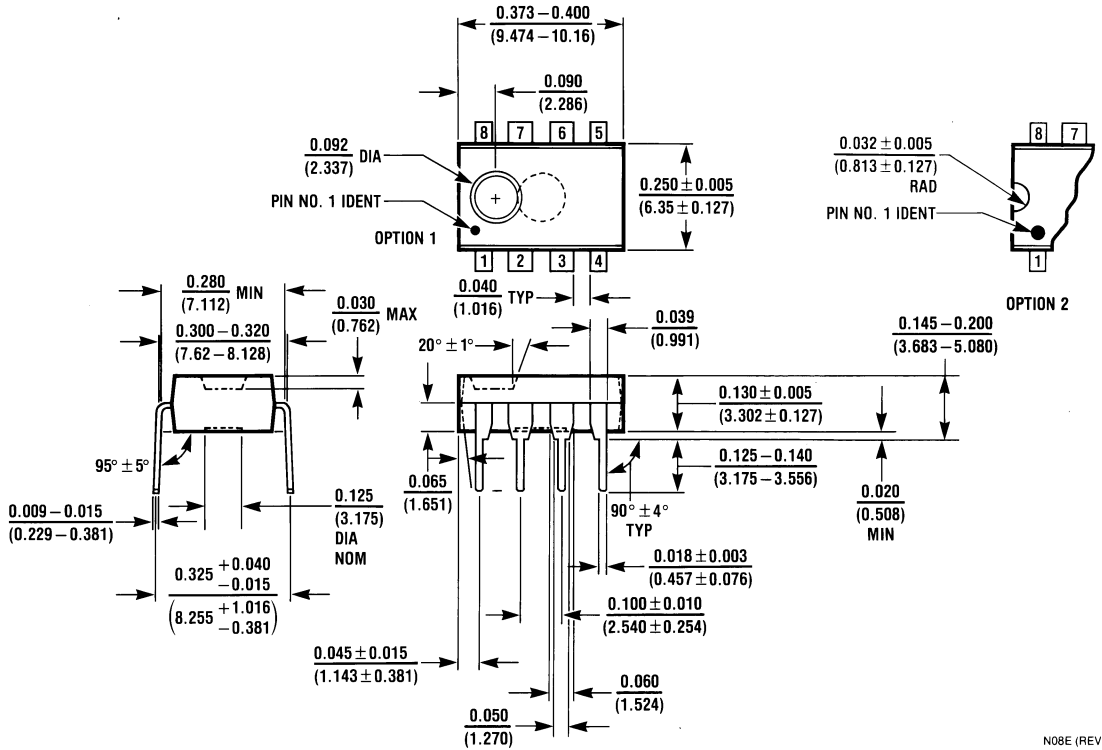

8-Lead (0.300" Wide) Molded Dual-In-Line Package
Order Number LM6132AIN, LM6132BIN
NS Package Number N08E

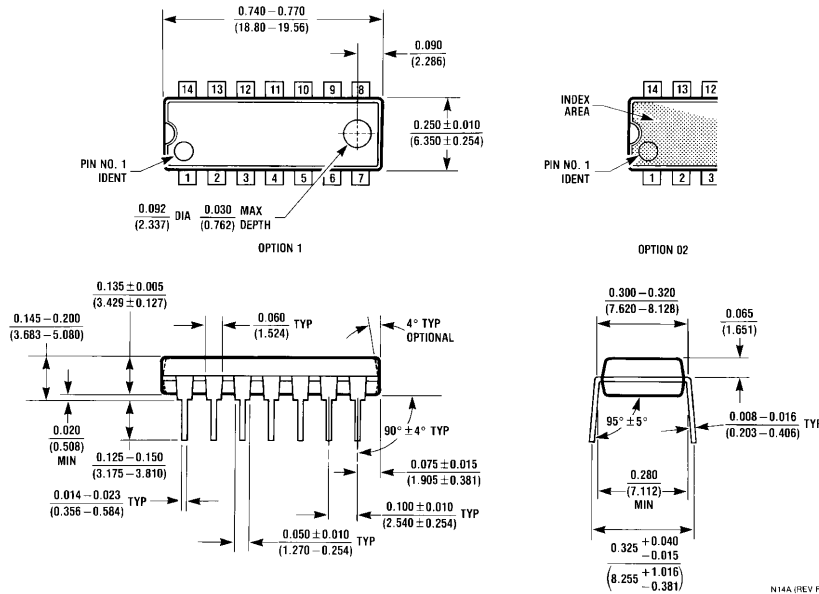

14-Lead (0.300" Wide) Molded Dual-In-Line Package
Order Number LM6134AIN, LM6134BIN
NS Package Number N14A

Notes

LIFE SUPPORT POLICY

NATIONAL'S PRODUCTS ARE NOT AUTHORIZED FOR USE AS CRITICAL COMPONENTS IN LIFE SUPPORT DEVICES OR SYSTEMS WITHOUT THE EXPRESS WRITTEN APPROVAL OF THE PRESIDENT AND GENERAL COUNSEL OF NATIONAL SEMICONDUCTOR CORPORATION. As used herein:

1. Life support devices or systems are devices or systems which, (a) are intended for surgical implant into the body, or (b) support or sustain life, and whose failure to perform when properly used in accordance with instructions for use provided in the labeling, can be reasonably expected to result in a significant injury to the user.
2. A critical component is any component of a life support device or system whose failure to perform can be reasonably expected to cause the failure of the life support device or system, or to affect its safety or effectiveness.



National Semiconductor Corporation
Americas
Tel: 1-800-272-9959
Fax: 1-800-737-7018
Email: support@nsc.com
www.national.com

National Semiconductor Europe
Fax: +49 (0) 180-530 85 86
Email: europe.support@nsc.com
Deutsch Tel: +49 (0) 69 9508 6208
English Tel: +44 (0) 870 24 0 2171
Français Tel: +33 (0) 1 41 91 8790

National Semiconductor Asia Pacific Customer Response Group
Tel: 65-2544466
Fax: 65-2504466
Email: ap.support@nsc.com

National Semiconductor Japan Ltd.
Tel: 81-3-5639-7560
Fax: 81-3-5639-7507