

### FEATURES

- Low Offset Voltage: 100  $\mu$ V max
- Low Drift: 2  $\mu$ V/ $^{\circ}$ C max
- Wide Gain Range 1 to 10,000
- High Common-Mode Rejection: 115 dB min
- High Bandwidth (G = 1000): 200 kHz typ
- Gain Equation Accuracy: 0.5% max
- Single Resistor Gain Set
- Input Overvoltage Protection
- Low Cost
- Available In Die Form

### APPLICATIONS

- Differential Amplifier
- Strain Gauge Amplifier
- Thermocouple Amplifier
- RTD Amplifier
- Programmable Gain Instrumentation Amplifier
- Medical Instrumentation
- Data Acquisition Systems

### GENERAL DESCRIPTION

The AMP02 is the first precision instrumentation amplifier available in an 8-pin package. Gain of the AMP02 is set by a single external resistor, and can range from 1 to 10,000. No gain set resistor is required for unity gain. The AMP02 includes an input protection network that allows the inputs to be taken 60 V beyond either supply rail without damaging the device.

Laser trimming reduces the input offset voltage to under 100  $\mu$ V. Output offset voltage is below 4 mV and gain accuracy is better than 0.5% for gain of 1000. PMI's proprietary thin-film resistor process keeps the gain temperature coefficient under 50 ppm/ $^{\circ}$ C.

Due to the AMP02's design, its bandwidth remains very high over a wide range of gain. Slew rate is over 4 V/ $\mu$ s making the AMP02 ideal for fast data acquisition systems.

### PIN CONNECTIONS

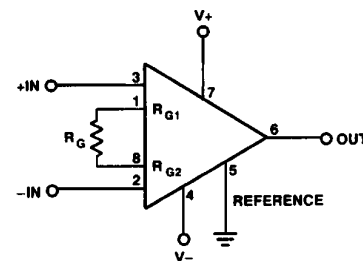
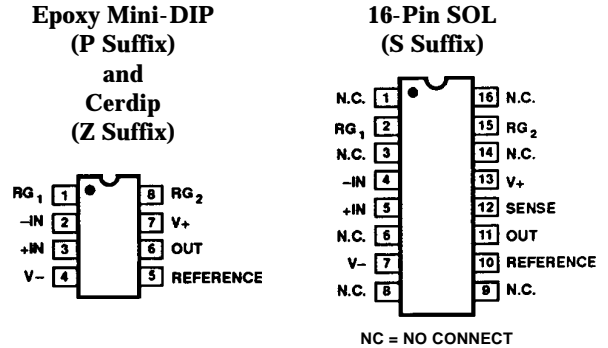

$$G = \frac{V_{OUT}}{(+IN) - (-IN)} = \left( \frac{50k\Omega}{R_G} \right) + 1$$

FOR SOL CONNECT SENSE TO OUTPUT

Figure 1. Basic Circuit Connections

A reference pin is provided to allow the output to be referenced to an external dc level. This pin may be used for offset correction or level shifting as required. In the 8-pin package, sense is internally connected to the output.

For an instrumentation amplifier with the highest precision, consult the AMP01 data sheet. For the highest input impedance and speed, consult the AMP05 data sheet.

### REV. D

Information furnished by Analog Devices is believed to be accurate and reliable. However, no responsibility is assumed by Analog Devices for its use, nor for any infringements of patents or other rights of third parties which may result from its use. No license is granted by implication or otherwise under any patent or patent rights of Analog Devices.

# AMP02-SPECIFICATIONS

## ELECTRICAL CHARACTERISTICS (@ $V_S = \pm 15\text{ V}$ , $V_{CM} = 0\text{ V}$ , $T_A = +25^\circ\text{C}$ , unless otherwise noted.)

Parameter	Symbol	Conditions	AMP02E			AMP02F			Units
			Min	Typ	Max	Min	Typ	Max	
<b>OFFSET VOLTAGE</b>									
Input Offset Voltage	$V_{IOS}$	$T_A = +25^\circ\text{C}$ $-40^\circ\text{C} \leq T_A \leq +85^\circ\text{C}$		20	100		40	200	$\mu\text{V}$
Input Offset Voltage Drift	$TCV_{IOS}$	$-40^\circ\text{C} \leq T_A \leq +85^\circ\text{C}$		50	200		100	350	$\mu\text{V}/^\circ\text{C}$
Output Offset Voltage	$V_{OOS}$	$T_A = +25^\circ\text{C}$ $-40^\circ\text{C} \leq T_A \leq +85^\circ\text{C}$		0.5	2		1	4	$\mu\text{V}/^\circ\text{C}$
Output Offset Voltage Drift	$TCV_{OOS}$	$-40^\circ\text{C} \leq T_A \leq +85^\circ\text{C}$		1	4		2	8	$\mu\text{V}/^\circ\text{C}$
Power Supply Rejection	PSR	$V_S = \pm 4.8\text{ V to } \pm 18\text{ V}$ $G = 100, 1000$ $G = 10$ $G = 1$		4	10		9	20	$\mu\text{V}/^\circ\text{C}$
		$V_S = \pm 4.8\text{ V to } \pm 18\text{ V}$ $-40^\circ\text{C} \leq T_A \leq +85^\circ\text{C}$ $G = 1000, 100$ $G = 10$ $G = 1$	115	125		110	115		dB
			100	110		95	100		dB
			80	90		75	80		dB
			110	120		105	110		dB
			95	110		90	95		dB
			75	90		70	75		dB
<b>INPUT CURRENT</b>									
Input Bias Current	$I_B$	$T_A = +25^\circ\text{C}$ $-40^\circ\text{C} \leq T_A \leq +85^\circ\text{C}$		2	10		4	20	nA
Input Bias Current Drift	$TCI_B$	$-40^\circ\text{C} \leq T_A \leq +85^\circ\text{C}$		150			250		$\text{pA}/^\circ\text{C}$
Input Offset Current	$I_{OS}$	$T_A = +25^\circ\text{C}$ $-40^\circ\text{C} \leq T_A \leq +85^\circ\text{C}$		1.2	5		2	10	nA
Input Offset Current Drift	$TCI_{OS}$	$-40^\circ\text{C} \leq T_A \leq +85^\circ\text{C}$		9			15		$\text{pA}/^\circ\text{C}$
<b>INPUT</b>									
Input Resistance	$R_{IN}$	Differential, $G \leq 1000$ Common-Mode, $G = 1000$		10			10		$\text{G}\Omega$
Input Voltage Range	IVR	$T_A = +25^\circ\text{C}$ (Note 1)	$\pm 11$	16.5		$\pm 11$	16.5		V
Common-Mode Rejection	CMR	$V_{CM} = \pm 11\text{ V}$ $G = 1000, 100$ $G = 10$ $G = 1$	115	120		110	115		dB
			100	115		95	110		dB
			80	95		75	90		dB
		$V_{CM} = \pm 11\text{ V}$ $-40^\circ\text{C} \leq T_A \leq +85^\circ\text{C}$ $G = 100, 1000$ $G = 10$ $G = 1$	110	120		105	115		dB
			95	110		90	105		dB
			75	90		70	85		dB
<b>GAIN</b>									
Gain Equation Accuracy	$G = \frac{50\text{ k}\Omega}{R_G} + 1$	$G = 1000$ $G = 100$ $G = 10$ $G = 1$			0.50			0.70	%
Gain Range	G		1		10k	1		10k	V/V
Nonlinearity		$G = 1$ to 1000		0.006			0.006		%
Temperature Coefficient	$G_{TC}$	$1 \leq G \leq 1000$ (Notes 2, 3)		20	50		20	50	$\text{ppm}/^\circ\text{C}$
<b>OUTPUT RATING</b>									
Output Voltage Swing	$V_{OUT}$	$T_A = +25^\circ\text{C}$ , $R_L = 1\text{ k}\Omega$ $R_L = 1\text{ k}\Omega$ , $-40^\circ\text{C} \leq T_A \leq +85^\circ\text{C}$	$\pm 12$ $\pm 11$	$\pm 13$ $\pm 12$		$\pm 12$ $\pm 11$	$\pm 13$ $\pm 12$		V V
Positive Current Limit		Output-to-Ground Short		22			22		mA
Negative Current Limit		Output-to-Ground Short		32			32		mA
<b>NOISE</b>									
Voltage Density, RTI	$e_n$	$f_O = 1\text{ kHz}$ $G = 1000$ $G = 100$ $G = 10$ $G = 1$		9 10 18 120			9 10 18 120		$\text{nV}/\sqrt{\text{Hz}}$ $\text{nV}/\sqrt{\text{Hz}}$ $\text{nV}/\sqrt{\text{Hz}}$ $\text{nV}/\sqrt{\text{Hz}}$
Noise Current Density, RTI	$i_n$	$f_O = 1\text{ kHz}$ , $G = 1000$		0.4			0.4		$\text{pA}/\sqrt{\text{Hz}}$
Input Noise Voltage	$e_n$ p-p	0.1 Hz to 10 Hz $G = 1000$ $G = 100$ $G = 10$		0.4 0.5 1.2			0.4 0.5 1.2		$\mu\text{V}$ p-p $\mu\text{V}$ p-p $\mu\text{V}$ p-p
<b>DYNAMIC RESPONSE</b>									
Small-Signal Bandwidth (-3 dB)	BW	$G = 1$ $G = 10$		1200 300			1200 300		kHz kHz
Slew Rate	SR	$G = 10$ , $R_L = 1\text{ k}\Omega$		200			200		kHz
Settling Time	$t_s$	To 0.01% $\pm 10\text{ V}$ Step $G = 1$ to 1000	4	6 10		4	6 10		V/ $\mu\text{s}$ $\mu\text{s}$
<b>SENSE INPUT</b>									
Input Resistance	$R_{IN}$			25			25		$\text{k}\Omega$
Voltage Range				$\pm 11$			$\pm 11$		V
<b>REFERENCE INPUT</b>									
Input Resistance	$R_{IN}$			50			50		$\text{k}\Omega$
Voltage Range				$\pm 11$			$\pm 11$		V
Gain to Output				1			1		V/V

Parameter	Symbol	Conditions	AMP02E			AMP02F			Units
			Min	Typ	Max	Min	Typ	Max	
POWER SUPPLY									
Supply Voltage Range	$V_S$	$T_A = +25^\circ\text{C}$ $-40^\circ\text{C} \leq T_A \leq +85^\circ\text{C}$	$\pm 4.5$		$\pm 18$	$\pm 4.5$		$\pm 18$	V
Supply Current	$I_{SY}$		5	5	6	5	5	6	mA

**NOTES**

<sup>1</sup>Input voltage range guaranteed by common-mode rejection test.

<sup>2</sup>Guaranteed by design.

<sup>3</sup>Gain tempo does not include the effects of external component drift.

Specifications subject to change without notice.

**ABSOLUTE MAXIMUM RATINGS**

Supply Voltage . . . . .  $\pm 18$  V

Common-Mode Input Voltage . [(V-) - 60 V] to [(V+) + 60 V]

Differential Input Voltage . . . [(V-) - 60 V] to [(V+) + 60 V]

Output Short-Circuit Duration . . . . . Continuous

Operating Temperature Range . . . . .  $-40^\circ\text{C}$  to  $+85^\circ\text{C}$

Storage Temperature Range . . . . .  $-65^\circ\text{C}$  to  $+150^\circ\text{C}$

Function Temperature Range . . . . .  $-65^\circ\text{C}$  to  $+150^\circ\text{C}$

Lead Temperature (Soldering, 10 sec) . . . . .  $+300^\circ\text{C}$

Package Type	$\theta_{JA}^2$	$\theta_{JC}$	Units
8-Pin Plastic DIP (P)	96	37	$^\circ\text{C}/\text{W}$
16-Pin SOL (S)	92	27	$^\circ\text{C}/\text{W}$

**NOTES**

<sup>1</sup>Absolute maximum ratings apply to both DICE and packaged parts, unless otherwise noted.

<sup>2</sup> $\theta_{JA}$  is specified for worst case mounting conditions, i.e.,  $\theta_{JA}$  is specified for device in socket for P-DIP package;  $\theta_{JA}$  is specified for device soldered to printed circuit board for SOL package.

**ORDERING GUIDE**

Model	$V_{IOS}$ max @ $T_A = +25^\circ\text{C}$	$V_{OOS}$ max @ $T_A = +25^\circ\text{C}$	Temperature Range	Package Description
AMP02EP	100 $\mu\text{V}$	4 mV	$-40^\circ\text{C}$ to $+85^\circ\text{C}$	8-Pin Plastic DIP
AMP02FP	200 $\mu\text{V}$	8 mV	$-40^\circ\text{C}$ to $+85^\circ\text{C}$	8-Pin Plastic DIP
AMP02AZ/883C	200 $\mu\text{V}$	10 mV	$-55^\circ\text{C}$ to $+125^\circ\text{C}$	8-Pin Cerdip
AMP02FS	200 $\mu\text{V}$	8 mV	$-40^\circ\text{C}$ to $+85^\circ\text{C}$	16-Pin SOIC
AMP02GBC				Die
AMP02FS-REEL	200 $\mu\text{V}$	8 mV	$-40^\circ\text{C}$ to $+85^\circ\text{C}$	16-Pin SOIC

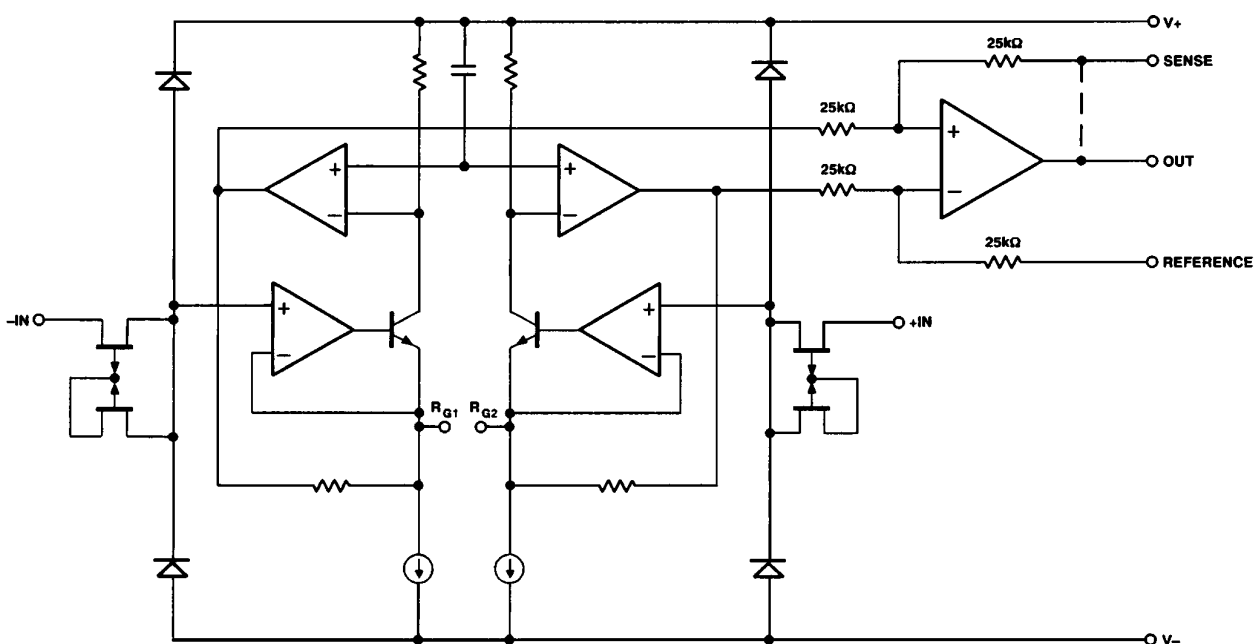
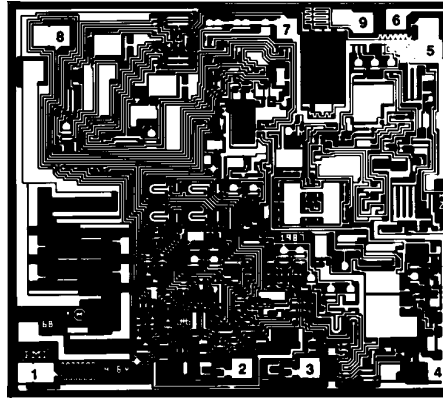

Figure 2. Simplified Schematic

# AMP02



- 1. RG<sub>1</sub>
- 2. -IN
- 3. +IN
- 4. V-
- 5. REFERENCE
- 6. OUT
- 7. V+
- 8. RG<sub>2</sub>
- 9. SENSE

CONNECT SUBSTRATE TO V-

DIE SIZE 0.103 X 0.116 inch, 11,948 sq. mils  
(2.62 X 2.95 mm, 7.73 sq. mm)

### Dice Characteristics

## WAFER TEST LIMITS at $V_S = \pm 15\text{ V}$ , $V_{CM} = 0\text{ V}$ , $T_A = +25^\circ\text{C}$ , unless otherwise noted.

Parameter	Symbol	Conditions	AMP02 GBC Limits	Units
Input Offset Voltage	$V_{IOS}$		200	$\mu\text{V}$ max
Output Offset Voltage	$V_{OOS}$		8	mV max
Power Supply Rejection	PSR	$V_S = \pm 4.8\text{ V to } \pm 18\text{ V}$ $G = 1000$ $G = 100$ $G = 10$ $G = 1$	110 110 95 75	dB min
Input Bias Current	$I_B$		20	nA max
Input Offset Current	$I_{OS}$		10	nA max
Input Voltage Range	IVR	Guaranteed by CMR Tests	$\pm 11$	V min
Common-Mode Rejection	CMR	$V_{CM} = \pm 11\text{ V}$ $G = 1000$ $G = 100$ $G = 10$ $G = 1$	110 110 95 75	dB min
Gain Equation Accuracy		$G = \frac{50\text{ k}\Omega}{R_G} + 1, G = 1000$	0.7	% max
Output Voltage Swing	$V_{OUT}$	$R_L = 1\text{ k}\Omega$	$\pm 12$	V min
Supply Current	$I_{SY}$		6	mA max

NOTE  
Electrical tests are performed at wafer probe to the limits shown. Due to variations in assembly methods and normal yield loss, yield after packaging is not guaranteed for standard product dice. Consult factory to negotiate specifications based on dice lot qualifications through sample lot assembly and testing.

### CAUTION

ESD (electrostatic discharge) sensitive device. Electrostatic charges as high as 4000 V readily accumulate on the human body and test equipment and can discharge without detection. Although the AMP02 features proprietary ESD protection circuitry, permanent damage may occur on devices subjected to high energy electrostatic discharges. Therefore, proper ESD precautions are recommended to avoid performance degradation or loss of functionality.



# Typical Performance Characteristics—AMP02

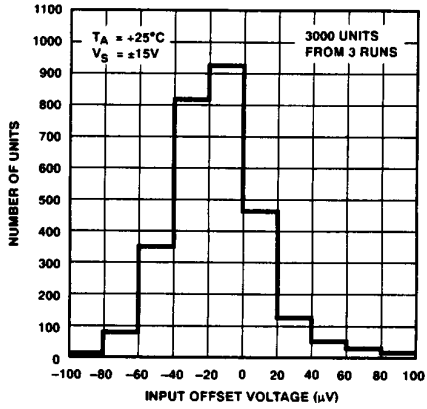

Figure 3. Typical Distribution of Input Offset Voltage

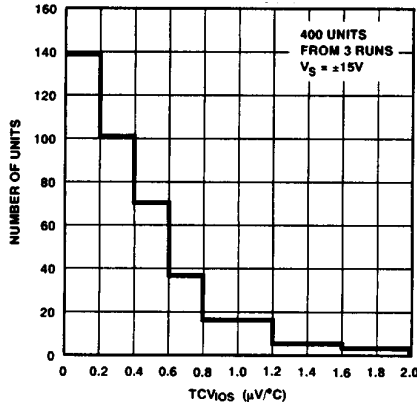

Figure 4. Typical Distribution of  $TCV_{ios}$

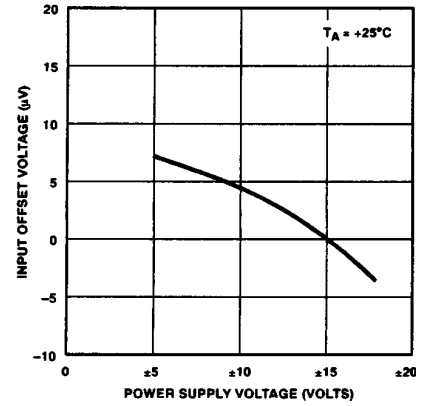

Figure 5. Input Offset Voltage Change vs. Supply Voltage

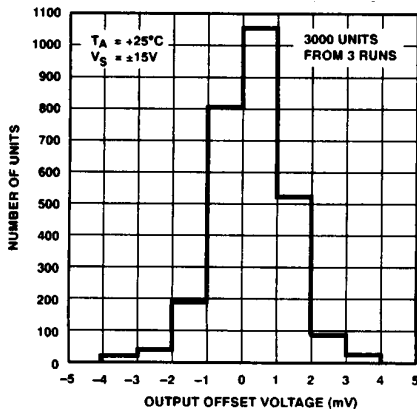

Figure 6. Typical Distribution of Output Offset Voltage

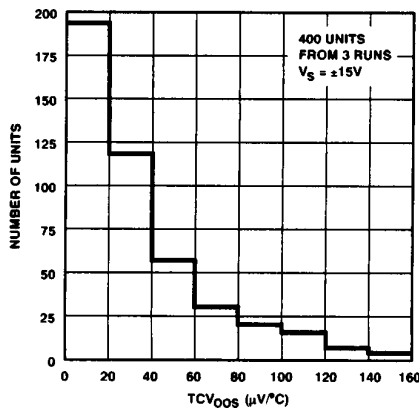

Figure 7. Typical Distribution of  $TCV_{oos}$

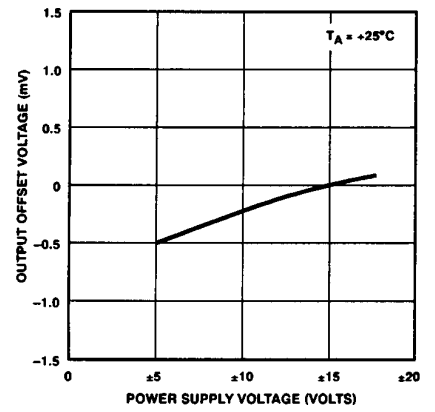

Figure 8. Output Offset Voltage Change vs. Supply Voltage

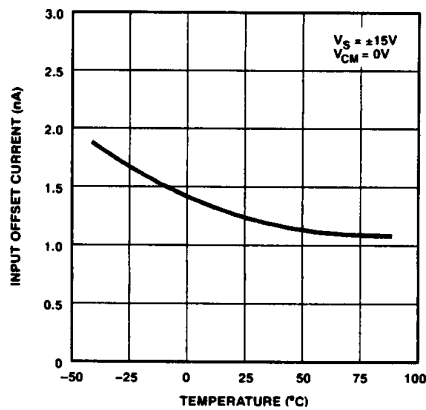

Figure 9. Input Offset Current vs. Temperature

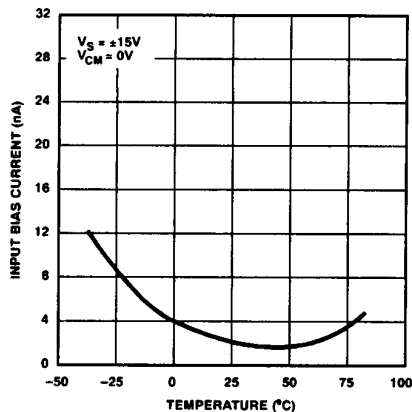

Figure 10. Input Bias Current vs. Temperature

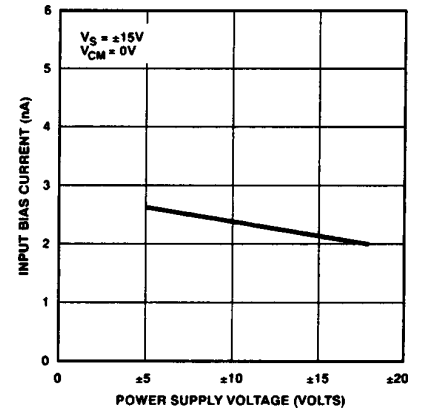

Figure 11. Input Bias Current vs. Supply Voltage

# AMP02

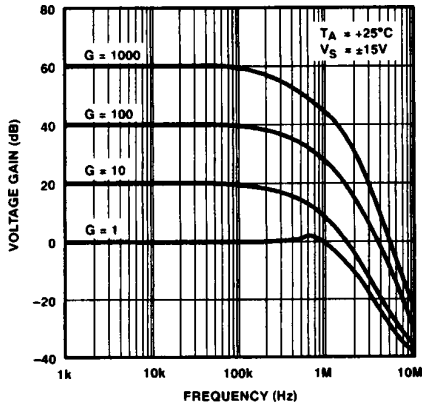

Figure 12. Closed-Loop Voltage Gain vs. Frequency

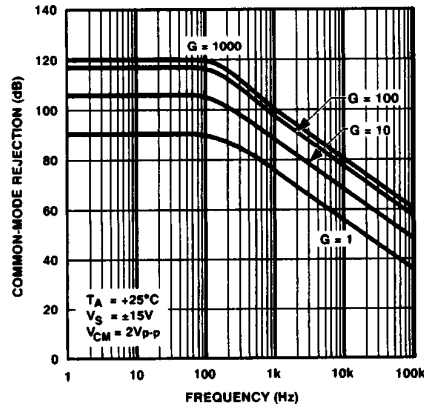

Figure 13. Common-Mode Rejection vs. Frequency

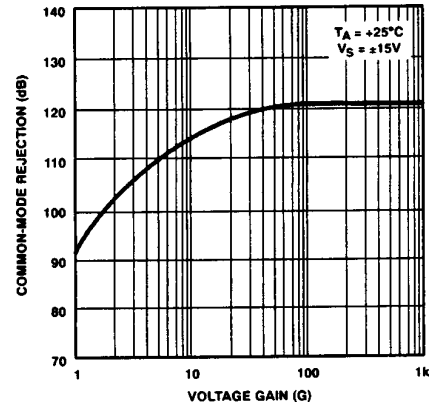

Figure 14. Common-Mode Rejection vs. Voltage Gain

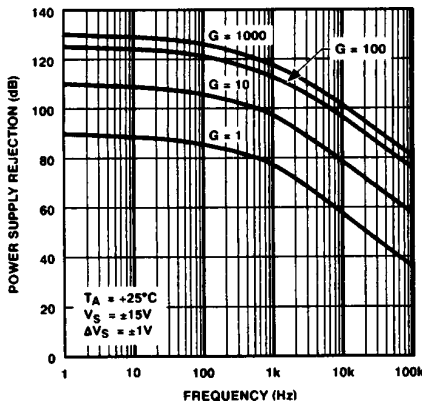

Figure 15. Positive PSR vs. Frequency

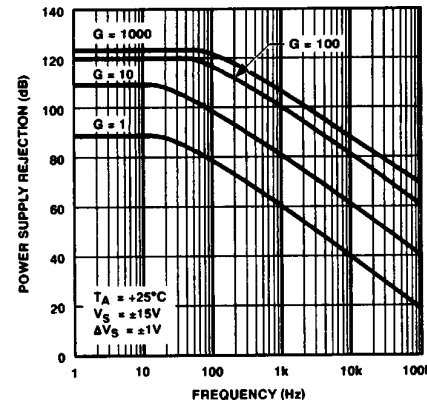

Figure 16. Negative PSR vs. Frequency

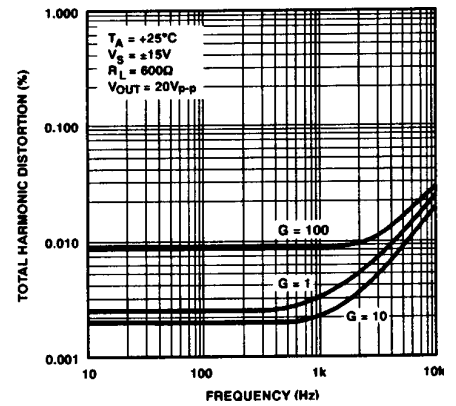

Figure 17. Total Harmonic Distortion vs. Frequency

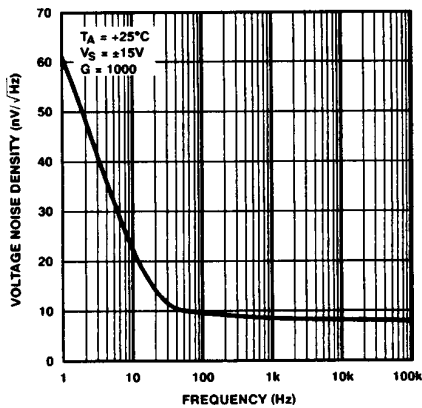

Figure 18. Voltage Noise Density vs. Frequency

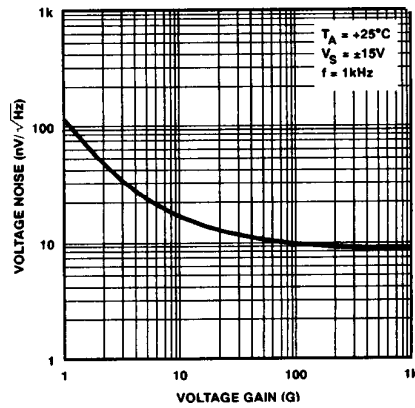

Figure 19. RTI Voltage Noise Density vs. Gain

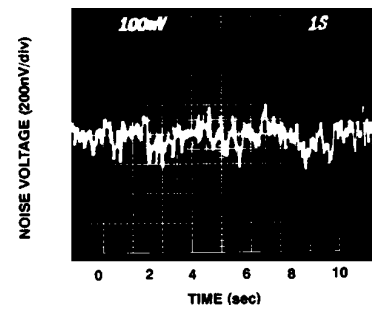

Figure 20. 0.1 Hz to 10 Hz Noise  $A_V = 1000$

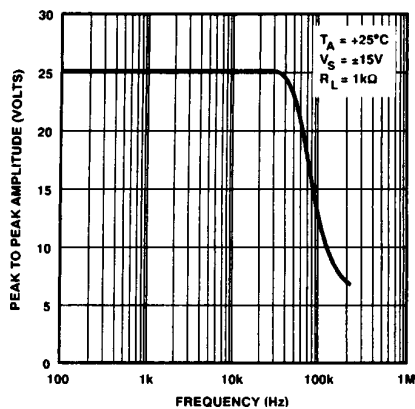

Figure 21. Maximum Output Swing vs. Frequency

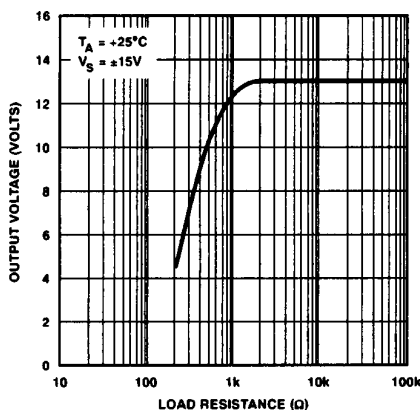

Figure 22. Maximum Output Voltage vs. Load Resistance

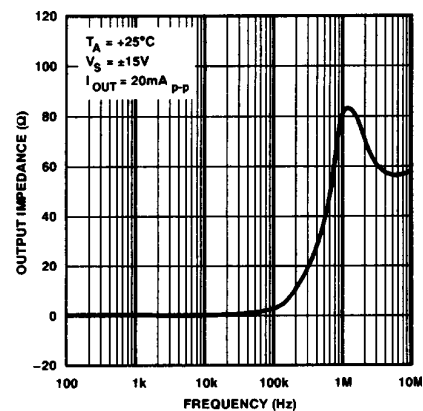

Figure 23. Closed Loop Output Impedance vs. Frequency

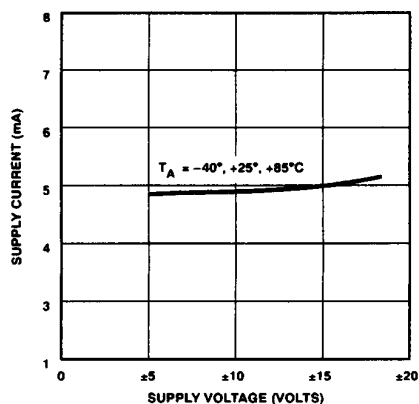

Figure 24. Supply Current vs. Supply Voltage

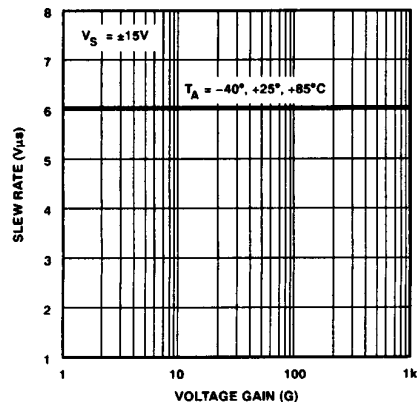

Figure 25. Slew Rate vs. Voltage Gain

# AMP02

## APPLICATIONS INFORMATION INPUT AND OUTPUT OFFSET VOLTAGES

Instrumentation amplifiers have independent offset voltages associated with the input and output stages. The input offset component is directly multiplied by the amplifier gain, whereas output offset is independent of gain. Therefore, at low gain, output-offset-errors dominate, while at high gain, input-offset-errors dominate. Overall offset voltage,  $V_{OS}$ , referred to the output (RTO) is calculated as follows:

$$V_{OS} (RTO) = (V_{IOS} \times G) + V_{OOS}$$

where  $V_{IOS}$  and  $V_{OOS}$  are the input and output offset voltage specifications and  $G$  is the amplifier gain.

The overall offset voltage drift  $TCV_{OS}$ , referred to the output, is a combination of input and output drift specifications. Input offset voltage drift is multiplied by the amplifier gain,  $G$ , and summed with the output offset drift:

$$TCV_{OS} (RTO) = (TCV_{IOS} \times G) + TCV_{OOS}$$

where  $TCV_{IOS}$  is the input offset voltage drift, and  $TCV_{OOS}$  is the output offset voltage drift. Frequently, the amplifier drift is referred back to the input (RTI) which is then equivalent to an input signal change:

$$TCV_{OS} (RTI) = TCV_{IOS} + \frac{TCV_{OOS}}{G}$$

For example, the maximum input-referred drift of an AMP02EP set to  $G = 1000$  becomes:

$$TCV_{OS} (RTI) = 2 \mu V/^{\circ}C + \frac{100 \mu V/^{\circ}C}{1000} = 2.1 \mu V/^{\circ}C$$

## INPUT BIAS AND OFFSET CURRENTS

Input transistor bias currents are additional error sources which can degrade the input signal. Bias currents flowing through the signal source resistance appear as an additional offset voltage. Equal source resistance on both inputs of an IA will minimize offset changes due to bias current variations with signal voltage and temperature. However, the difference between the two bias currents, the input offset current, produces an error. The magnitude of the error is the offset current times the source resistance.

A current path must always be provided between the differential inputs and analog ground to ensure correct amplifier operation. Floating inputs, such as thermocouples, should be grounded close to the signal source for best common-mode rejection.

## GAIN

The AMP02 only requires a single external resistor to set the voltage gain. The voltage gain,  $G$ , is:

$$G = \frac{50 \text{ k}\Omega}{R_G} + 1$$

and

$$R_G = \frac{50 \text{ k}\Omega}{G - 1}$$

The voltage gain can range from 1 to 10,000. A gain set resistor is not required for unity-gain applications. Metal-film or wire-wound resistors are recommended for best results.

The total gain accuracy of the AMP02 is determined by the tolerance of the external gain set resistor,  $R_G$ , combined with the gain equation accuracy of the AMP02. Total gain drift combines the mismatch of the external gain set resistor drift with that of the internal resistors (20 ppm/ $^{\circ}C$  typ). Maximum gain drift of the AMP02 independent of the external gain set resistor is 50 ppm/ $^{\circ}C$ .

All instrumentation amplifiers require attention to layout so thermocouple effects are minimized. Thermocouples formed between copper and dissimilar metals can easily destroy the  $TCV_{OS}$  performance of the AMP02 which is typically 0.5  $\mu V/^{\circ}C$ . Resistors themselves can generate thermoelectric EMFs when mounted parallel to a thermal gradient.

The AMP02 uses the triple op amp instrumentation amplifier configuration with the input stage consisting of two transimpedance amplifiers followed by a unity-gain differential amplifier. The input stage and output buffer are laser-trimmed to increase gain accuracy. The AMP02 maintains wide bandwidth at all gains as shown in Figure 26. For voltage gains greater than 10, the bandwidth is over 200 kHz. At unity-gain, the bandwidth of the AMP02 exceeds 1 MHz.

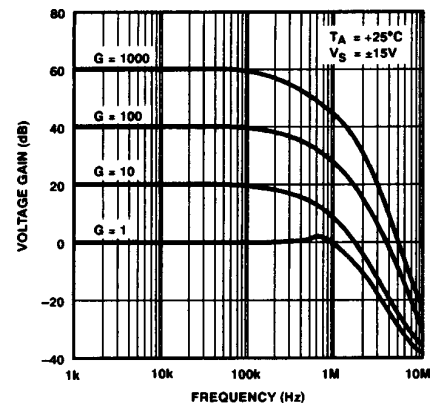

Figure 26. The AMP02 Keeps Its Bandwidth at High Gains

## COMMON-MODE REJECTION

Ideally, an instrumentation amplifier responds only to the difference between the two input signals and rejects common-mode voltages and noise. In practice, there is a small change in output voltage when both inputs experience the same common-mode voltage change; the ratio of these voltages is called the common-mode gain. Common-mode rejection (CMR) is the logarithm of the ratio of differential-mode gain to common-mode gain, expressed in dB. Laser trimming is used to achieve the high CMR of the AMP02.



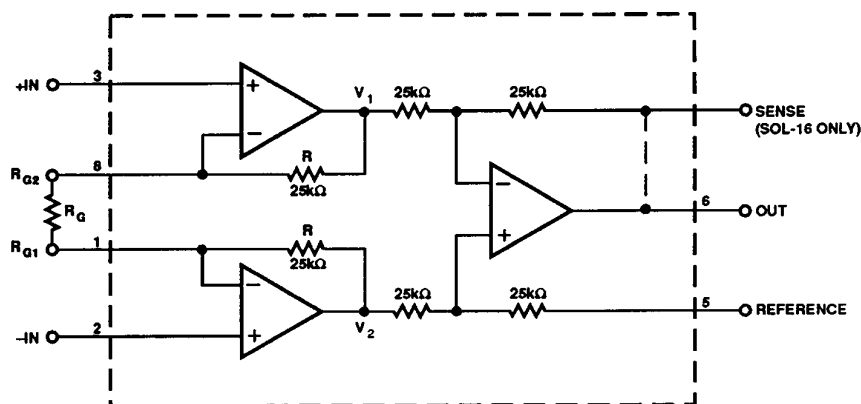

Figure 27. Triple Op Amp Topology of the AMP02

Figure 27 shows the triple op amp configuration of the AMP02. With all instrumentation amplifiers of this type, it is critical not to exceed the dynamic range of the input amplifiers. The amplified differential input signal and the input common-mode voltage must not force the amplifier's output voltage beyond  $\pm 12$  V ( $V_S = \pm 15$  V) or nonlinear operation will result.

The input stage amplifier's output voltages at  $V_1$  and  $V_2$  equals:

$$\begin{aligned} V_1 &= -\left(1 + \frac{2R}{R_G}\right) \frac{V_D}{2} + V_{CM} \\ &= -G \frac{V_D}{2} + V_{CM} \end{aligned}$$

$$\begin{aligned} V_2 &= \left(1 + \frac{2R}{R_G}\right) \frac{V_D}{2} + V_{CM} \\ &= G \frac{V_D}{2} + V_{CM} \end{aligned}$$

where

$$\begin{aligned} V_D &= \text{Differential input voltage} \\ &= (+IN) - (-IN) \end{aligned}$$

$$V_{CM} = \text{Common-mode input voltage}$$

$$G = \text{Gain of instrumentation amplifier}$$

If  $V_1$  and  $V_2$  can equal  $\pm 12$  V maximum, then the common-mode input voltage range is:

$$CMVR = \pm \left(12 \text{ V} - \frac{GV_D}{2}\right)$$

### GROUNDING

The majority of instruments and data acquisition systems the separate grounds for analog and digital signals. Analog ground may also be divided into two or more grounds which will be tied together at one point, usually the analog power-supply ground. In addition, the digital and analog grounds may be joined, normally at the analog ground pin on the A to D converter. Follow this basic practice is essential for good circuit performance.

Mixing grounds causes interactions between digital circuits and the analog signals. Since the ground returns have finite resistance and inductance, hundreds of millivolts can be developed between the system ground and the data acquisition components. Using separate ground returns minimizes the current flow in the sensitive analog return path to the system ground point. Consequently, noisy ground currents from logic gates do interact with the analog signals.

Inevitably, two or more circuits will be joined together with their grounds at differential potentials. In these situations, the differential input of an instrumentation amplifier, with its high CMR, can accurately transfer analog information from one circuit to another.

### SENSE AND REFERENCE TERMINALS

The sense terminal completes the feedback path for the instrumentation amplifier output stage and is internally connected directly to the output. For SOL devices, connect the sense terminal to the output. The output signal is specified with respect to the reference terminal, which is normally connected to analog ground. The reference may also be used for offset correction level shifting. A reference source resistance will reduce the common-mode rejection by the ratio of  $25 \text{ k}\Omega/R_{REF}$ . If the reference source resistance is  $1 \Omega$ , then the CMR will be reduced 88 dB ( $25 \text{ k}\Omega/1 \Omega = 88 \text{ dB}$ ).

# AMP02

## OVERVOLTAGE PROTECTION

Instrumentation amplifiers invariably sit at the front end of instrumentation systems where there is a high probability of exposure to overloads. Voltage transients, failure of a transducer, or removal of the amplifier power supply while the signal source is connected may destroy or degrade the performance of an unprotected device. A common technique used is to place limiting resistors in series with each input, but this adds noise. The AMP02 includes internal protection circuitry that limits the input current to  $\pm 4$  mA for a 60 V differential overload (see Figure 28) with power off,  $\pm 2.5$  mA with power on.

## POWER SUPPLY CONSIDERATIONS

Achieving the rated performance of precision amplifiers in a practical circuit requires careful attention to external influences. For example, supply noise and changes in the nominal voltage directly affect the input offset voltage. A PSR of 80 dB means that a change of 100 mV on the supply, not an uncommon value, will produce a  $10 \mu\text{V}$  input offset change. Consequently, care should be taken in choosing a power unit that has a low output noise level, good line and load regulation, and good temperature stability. In addition, each power supply should be properly bypassed.

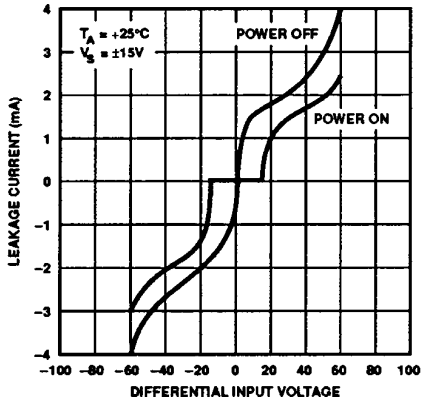
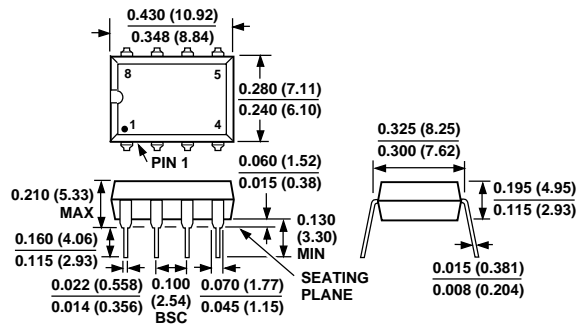

Figure 28. AMP02's Input Protection Circuitry Limits Input Current During Overvoltage Conditions

**OUTLINE DIMENSIONS**

Dimensions shown in inches and (mm).

**Mini-Dip (N-8) Package**



**Cerdip (Q-8) Package**

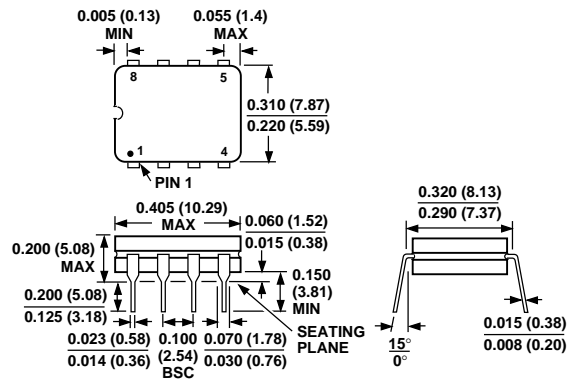

**SOL (R-16) Package**

