

GENERAL DESCRIPTION

The CM2830/CM2830A family is a positive voltage linear regulator developed utilizing CMOS technology featured low quiescent current (30 μ A typ.), low dropout voltage, and high output voltage accuracy. Built-in low on-resistance transistor provides low dropout voltage and large output current. A 2.2 μ F or greater can be used as an output capacitor.

The SOT-23-3, SOT-23-5, and TO-92 miniaturized package and the SOT-89 package are recommended for configuring portable devices and large current application, respectively.

These robust devices are designed to prevent device failure under the worst operation condition with both Thermal Shutdown and Current Fold-back.

FEATURES

- ◆ Very Low Dropout Voltage
- ◆ Low Current Consumption: Typ. 30 μ A, Max. 35 μ A
- ◆ Output Voltage: 1.5V, 1.8V, 1.9V, 2.0V, 2.2V, 2.5V, 2.7V, 2.8V, 2.9V, 3.0V, 3.3V, 3.5V, 3.6V, and 3.8V
- ◆ High Accuracy Output Voltage: +/- 1.5%
- ◆ Guaranteed 300mA Output
- ◆ Input Range up to 7.0V
- ◆ Thermal Shutdown
- ◆ Current Limiting
- ◆ Compact Package: TO-92, SOT-23-3, SOT-23-5, and SOT-89
- ◆ Factory Pre-set Output Voltages
- ◆ Short Circuit Current Fold-Back
- ◆ Low Temperature Coefficient

APPLICATIONS

- ◆ Battery-powered devices
- ◆ Personal communication devices
- ◆ Home electric/electronic appliances
- ◆ PC peripherals

TYPICAL APPLICATIONS

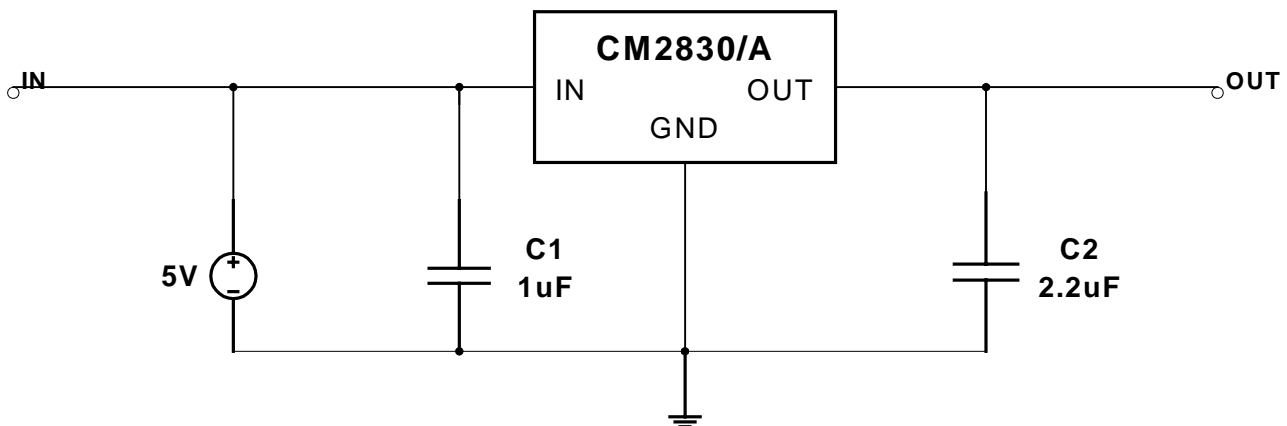

PIN CONFIGURATION

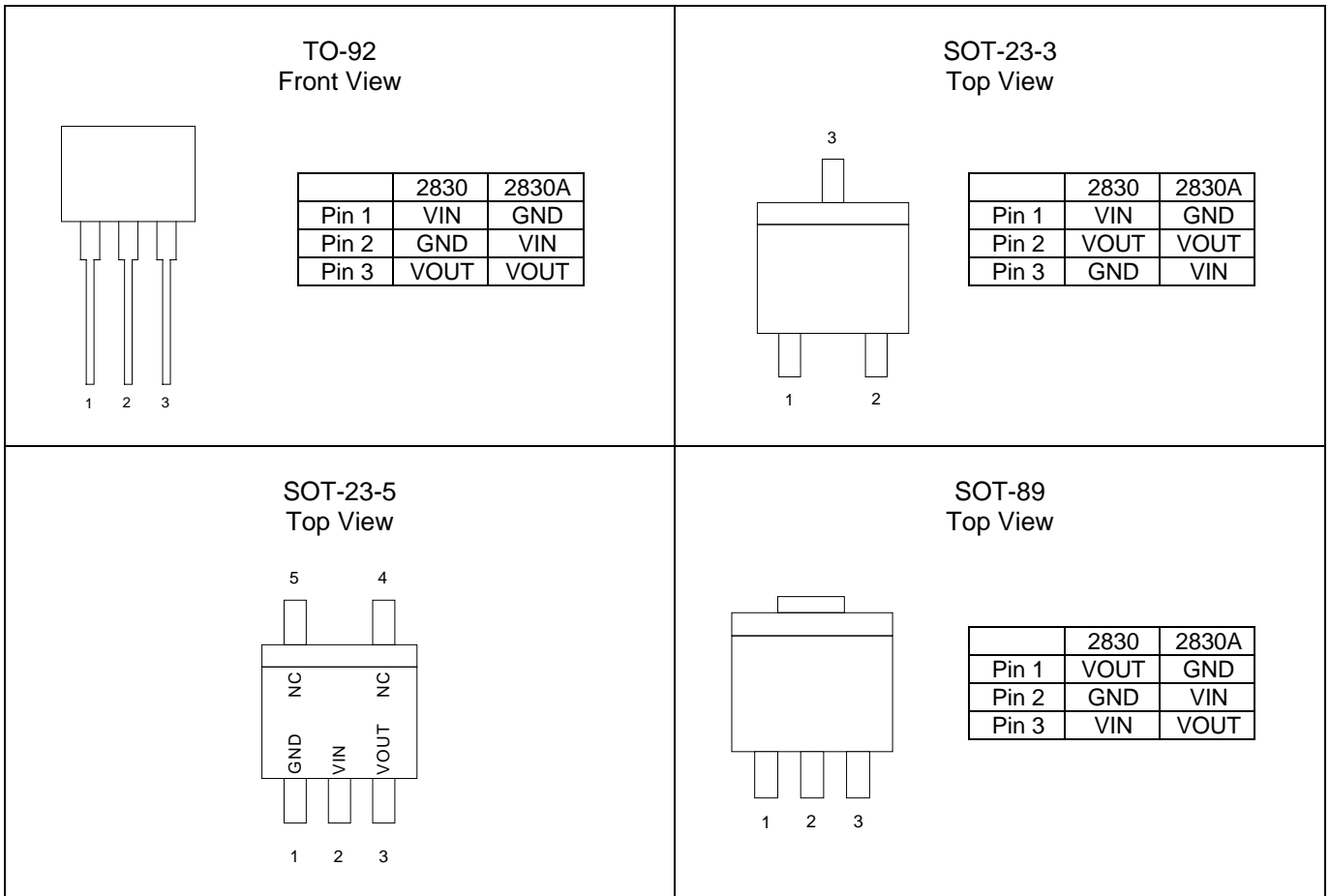

BLOCK DIAGRAM

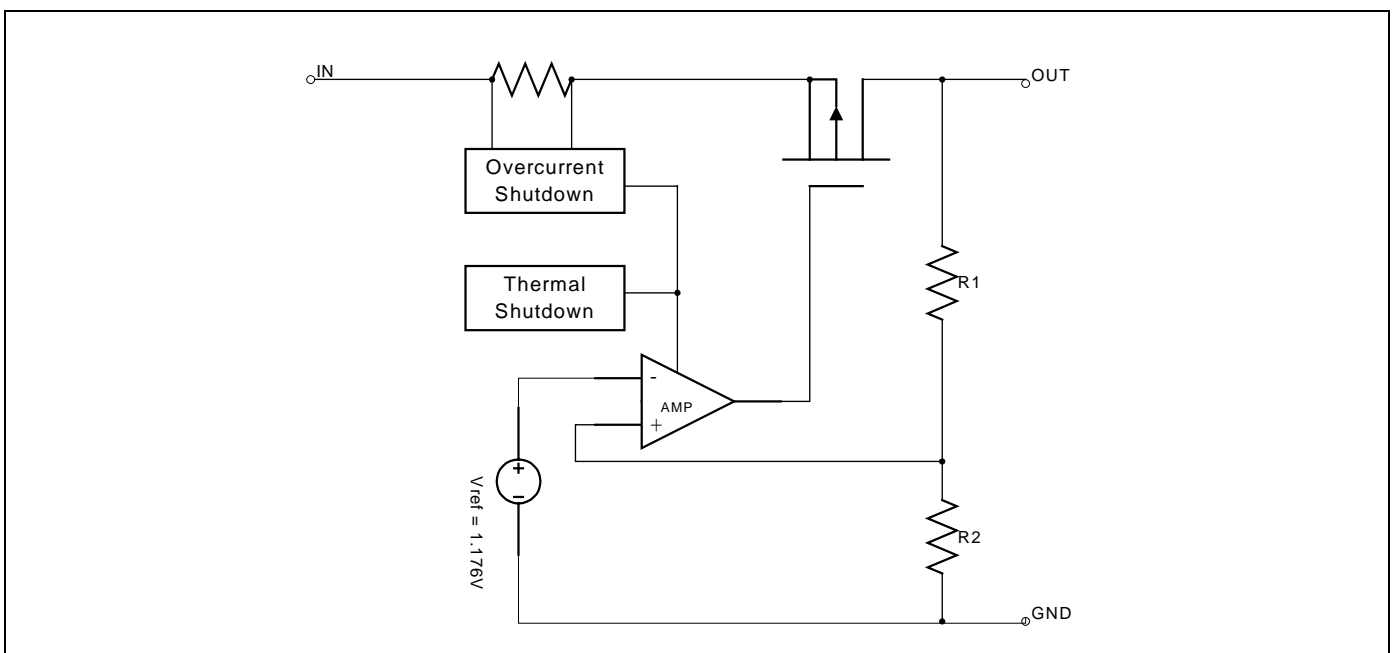

ORDERING INFORMATION**CM2830**

Part Number	Output Voltage	Temperature Range	Package
CM2830AIN92	1.5V	-40°C ~ +85°C	TO-92
CM2830AIM23	1.5V	-40°C ~ +85°C	SOT-23-3
CM2830AIM25	1.5V	-40°C ~ +85°C	SOT-23-5
CM2830AIM89	1.5V	-40°C ~ +85°C	SOT-89
CM2830DIN92	1.8V	-40°C ~ +85°C	TO-92
CM2830DIM23	1.8V	-40°C ~ +85°C	SOT-23-3
CM2830DIM25	1.8V	-40°C ~ +85°C	SOT-23-5
CM2830DIM89	1.8V	-40°C ~ +85°C	SOT-89
CM2830EIN92	1.9V	-40°C ~ +85°C	TO-92
CM2830EIM23	1.9V	-40°C ~ +85°C	SOT-23-3
CM2830EIM25	1.9V	-40°C ~ +85°C	SOT-23-5
CM2830EIM89	1.9V	-40°C ~ +85°C	SOT-89
CM2830FIN92	2.0V	-40°C ~ +85°C	TO-92
CM2830FIM23	2.0V	-40°C ~ +85°C	SOT-23-3
CM2830FIM25	2.0V	-40°C ~ +85°C	SOT-23-5
CM2830FIM89	2.0V	-40°C ~ +85°C	SOT-89
CM2830HIN92	2.2V	-40°C ~ +85°C	TO-92
CM2830HIM23	2.2V	-40°C ~ +85°C	SOT-23-3
CM2830HIM25	2.2V	-40°C ~ +85°C	SOT-23-5
CM2830HIM89	2.2V	-40°C ~ +85°C	SOT-89
CM2830KIN92	2.5V	-40°C ~ +85°C	TO-92
CM2830KIM23	2.5V	-40°C ~ +85°C	SOT-23-3
CM2830KIM25	2.5V	-40°C ~ +85°C	SOT-23-5
CM2830KIM89	2.5V	-40°C ~ +85°C	SOT-89
CM2830MIN92	2.7V	-40°C ~ +85°C	TO-92
CM2830MIM23	2.7V	-40°C ~ +85°C	SOT-23-3
CM2830MIM25	2.7V	-40°C ~ +85°C	SOT-23-5
CM2830MIM89	2.7V	-40°C ~ +85°C	SOT-89
CM2830NIN92	2.8V	-40°C ~ +85°C	TO-92
CM2830NIM23	2.8V	-40°C ~ +85°C	SOT-23-3
CM2830NIM25	2.8V	-40°C ~ +85°C	SOT-23-5
CM2830NIM89	2.8V	-40°C ~ +85°C	SOT-89
CM2830OIN92	2.9V	-40°C ~ +85°C	TO-92
CM2830OIM23	2.9V	-40°C ~ +85°C	SOT-23-3
CM2830OIM25	2.9V	-40°C ~ +85°C	SOT-23-5
CM2830OIM89	2.9V	-40°C ~ +85°C	SOT-89
CM2830PIN92	3.0V	-40°C ~ +85°C	TO-92
CM2830PIM23	3.0V	-40°C ~ +85°C	SOT-23-3
CM2830PIM25	3.0V	-40°C ~ +85°C	SOT-23-5
CM2830PIM89	3.0V	-40°C ~ +85°C	SOT-89

ORDERING INFORMATION (CONTINUED)

Part Number	Output Voltage	Temperature Range	Package
CM2830SIN92	3.3V	-40°C ~ +85°C	TO-92
CM2830SIM23	3.3V	-40°C ~ +85°C	SOT-23-3
CM2830SIM25	3.3V	-40°C ~ +85°C	SOT-23-5
CM2830SIM89	3.3V	-40°C ~ +85°C	SOT-89
CM2830UIN92	3.5V	-40°C ~ +85°C	TO-92
CM2830UIM23	3.5V	-40°C ~ +85°C	SOT-23-3
CM2830UIM25	3.5V	-40°C ~ +85°C	SOT-23-5
CM2830UIM89	3.5V	-40°C ~ +85°C	SOT-89
CM2830VIN92	3.6V	-40°C ~ +85°C	TO-92
CM2830VIM23	3.6V	-40°C ~ +85°C	SOT-23-3
CM2830VIM25	3.6V	-40°C ~ +85°C	SOT-23-5
CM2830VIM89	3.6V	-40°C ~ +85°C	SOT-89
CM2830XIN92	3.8V	-40°C ~ +85°C	TO-92
CM2830XIM23	3.8V	-40°C ~ +85°C	SOT-23-3
CM2830XIM25	3.8V	-40°C ~ +85°C	SOT-23-5
CM2830XIM89	3.8V	-40°C ~ +85°C	SOT-89
CM2830GAIN92	1.5V	-40°C ~ +85°C	TO-92
CM2830GAIM23	1.5V	-40°C ~ +85°C	SOT-23-3
CM2830GAIM25	1.5V	-40°C ~ +85°C	SOT-23-5
CM2830GAIM89	1.5V	-40°C ~ +85°C	SOT-89
CM2830GDIN92	1.8V	-40°C ~ +85°C	TO-92
CM2830GDIM23	1.8V	-40°C ~ +85°C	SOT-23-3
CM2830GDIM25	1.8V	-40°C ~ +85°C	SOT-23-5
CM2830GDIM89	1.8V	-40°C ~ +85°C	SOT-89
CM2830GEIN92	1.9V	-40°C ~ +85°C	TO-92
CM2830GEIM23	1.9V	-40°C ~ +85°C	SOT-23-3
CM2830GEIM25	1.9V	-40°C ~ +85°C	SOT-23-5
CM2830GEIM89	1.9V	-40°C ~ +85°C	SOT-89
CM2830GFIN92	2.0V	-40°C ~ +85°C	TO-92
CM2830GFIM23	2.0V	-40°C ~ +85°C	SOT-23-3
CM2830GFIM25	2.0V	-40°C ~ +85°C	SOT-23-5
CM2830GFIM89	2.0V	-40°C ~ +85°C	SOT-89
CM2830GHIN92	2.2V	-40°C ~ +85°C	TO-92
CM2830GHIM23	2.2V	-40°C ~ +85°C	SOT-23-3
CM2830GHIM25	2.2V	-40°C ~ +85°C	SOT-23-5
CM2830GHIM89	2.2V	-40°C ~ +85°C	SOT-89
CM2830GKIN92	2.5V	-40°C ~ +85°C	TO-92
CM2830GKIM23	2.5V	-40°C ~ +85°C	SOT-23-3
CM2830GKIM25	2.5V	-40°C ~ +85°C	SOT-23-5
CM2830GKIM89	2.5V	-40°C ~ +85°C	SOT-89
CM2830GMIN92	2.7V	-40°C ~ +85°C	TO-92
CM2830GMIM23	2.7V	-40°C ~ +85°C	SOT-23-3
CM2830GMIM25	2.7V	-40°C ~ +85°C	SOT-23-5
CM2830GMIM89	2.7V	-40°C ~ +85°C	SOT-89

ORDERING INFORMATION (CONTINUED)

Part Number	Output Voltage	Temperature Range	Package
CM2830GNIN92	2.8V	-40°C ~ +85°C	TO-92
CM2830GNIM23	2.8V	-40°C ~ +85°C	SOT-23-3
CM2830GNIM25	2.8V	-40°C ~ +85°C	SOT-23-5
CM2830GNIM89	2.8V	-40°C ~ +85°C	SOT-89
CM2830GOIN92	2.9V	-40°C ~ +85°C	TO-92
CM2830GOIM23	2.9V	-40°C ~ +85°C	SOT-23-3
CM2830GOIM25	2.9V	-40°C ~ +85°C	SOT-23-5
CM2830GOIM89	2.9V	-40°C ~ +85°C	SOT-89
CM2830GPIN92	3.0V	-40°C ~ +85°C	TO-92
CM2830GPIM23	3.0V	-40°C ~ +85°C	SOT-23-3
CM2830GPIM25	3.0V	-40°C ~ +85°C	SOT-23-5
CM2830GPIM89	3.0V	-40°C ~ +85°C	SOT-89
CM2830GSIN92	3.3V	-40°C ~ +85°C	TO-92
CM2830GSIM23	3.3V	-40°C ~ +85°C	SOT-23-3
CM2830GSIM25	3.3V	-40°C ~ +85°C	SOT-23-5
CM2830GSIM89	3.3V	-40°C ~ +85°C	SOT-89
CM2830GUIN92	3.5V	-40°C ~ +85°C	TO-92
CM2830GUIM23	3.5V	-40°C ~ +85°C	SOT-23-3
CM2830GUIM25	3.5V	-40°C ~ +85°C	SOT-23-5
CM2830GUIM89	3.5V	-40°C ~ +85°C	SOT-89
CM2830GVIN92	3.6V	-40°C ~ +85°C	TO-92
CM2830GVIM23	3.6V	-40°C ~ +85°C	SOT-23-3
CM2830GVIM25	3.6V	-40°C ~ +85°C	SOT-23-5
CM2830GVIM89	3.6V	-40°C ~ +85°C	SOT-89
CM2830GXIN92	3.8V	-40°C ~ +85°C	TO-92
CM2830GXIM23	3.8V	-40°C ~ +85°C	SOT-23-3
CM2830GXIM25	3.8V	-40°C ~ +85°C	SOT-23-5
CM2830GXIM89	3.8V	-40°C ~ +85°C	SOT-89

Note: For other pre-set output voltage, please contact Champion Sales office.

ORDERING INFORMATION (CONTINUED)**CM2830A**

Part Number	Output Voltage	Temperature Range	Package
CM2830AAIN92	1.5V	-40°C ~ +85°C	TO-92
CM2830AAIM23	1.5V	-40°C ~ +85°C	SOT-23-3
CM2830AAIM89	1.5V	-40°C ~ +85°C	SOT-89
CM2830ADIN92	1.8V	-40°C ~ +85°C	TO-92
CM2830ADIM23	1.8V	-40°C ~ +85°C	SOT-23-3
CM2830ADIM89	1.8V	-40°C ~ +85°C	SOT-89
CM2830AEIN92	1.9V	-40°C ~ +85°C	TO-92
CM2830AEIM23	1.9V	-40°C ~ +85°C	SOT-23-3
CM2830AEIM89	1.9V	-40°C ~ +85°C	SOT-89
CM2830AFIN92	2.0V	-40°C ~ +85°C	TO-92
CM2830AFIM23	2.0V	-40°C ~ +85°C	SOT-23-3
CM2830AFIM89	2.0V	-40°C ~ +85°C	SOT-89
CM2830AHIN92	2.2V	-40°C ~ +85°C	TO-92
CM2830AHIM23	2.2V	-40°C ~ +85°C	SOT-23-3
CM2830AHIM89	2.2V	-40°C ~ +85°C	SOT-89
CM2830AKIN92	2.5V	-40°C ~ +85°C	TO-92
CM2830AKIM23	2.5V	-40°C ~ +85°C	SOT-23-3
CM2830AKIM89	2.5V	-40°C ~ +85°C	SOT-89
CM2830AMIN92	2.7V	-40°C ~ +85°C	TO-92
CM2830AMIM23	2.7V	-40°C ~ +85°C	SOT-23-3
CM2830AMIM89	2.7V	-40°C ~ +85°C	SOT-89
CM2830ANIN92	2.8V	-40°C ~ +85°C	TO-92
CM2830ANIM23	2.8V	-40°C ~ +85°C	SOT-23-3
CM2830ANIM89	2.8V	-40°C ~ +85°C	SOT-89
CM2830AOIN92	2.9V	-40°C ~ +85°C	TO-92
CM2830AOIM23	2.9V	-40°C ~ +85°C	SOT-23-3
CM2830AOIM89	2.9V	-40°C ~ +85°C	SOT-89
CM2830APIN92	3.0V	-40°C ~ +85°C	TO-92
CM2830APIM23	3.0V	-40°C ~ +85°C	SOT-23-3
CM2830APIM89	3.0V	-40°C ~ +85°C	SOT-89
CM2830ASIN92	3.3V	-40°C ~ +85°C	TO-92
CM2830ASIM23	3.3V	-40°C ~ +85°C	SOT-23-3
CM2830ASIM89	3.3V	-40°C ~ +85°C	SOT-89
CM2830AUIN92	3.5V	-40°C ~ +85°C	TO-92
CM2830AUIM23	3.5V	-40°C ~ +85°C	SOT-23-3
CM2830AUIM89	3.5V	-40°C ~ +85°C	SOT-89
CM2830AVIN92	3.6V	-40°C ~ +85°C	TO-92
CM2830AVIM23	3.6V	-40°C ~ +85°C	SOT-23-3
CM2830AVIM89	3.6V	-40°C ~ +85°C	SOT-89
CM2830AXIN92	3.8V	-40°C ~ +85°C	TO-92
CM2830AXIM23	3.8V	-40°C ~ +85°C	SOT-23-3
CM2830AXIM89	3.8V	-40°C ~ +85°C	SOT-89

ORDERING INFORMATION (CONTINUED)

Part Number	Output Voltage	Temperature Range	Package
CM2830AGAIN92	1.5V	-40°C ~ +85°C	TO-92
CM2830AGAIM23	1.5V	-40°C ~ +85°C	SOT-23-3
CM2830AGAIM89	1.5V	-40°C ~ +85°C	SOT-89
CM2830AGDIN92	1.8V	-40°C ~ +85°C	TO-92
CM2830AGDIM23	1.8V	-40°C ~ +85°C	SOT-23-3
CM2830AGDIM89	1.8V	-40°C ~ +85°C	SOT-89
CM2830AGEIN92	1.9V	-40°C ~ +85°C	TO-92
CM2830AGEIM23	1.9V	-40°C ~ +85°C	SOT-23-3
CM2830AGEIM89	1.9V	-40°C ~ +85°C	SOT-89
CM2830AGFIN92	2.0V	-40°C ~ +85°C	TO-92
CM2830AGFIM23	2.0V	-40°C ~ +85°C	SOT-23-3
CM2830AGFIM89	2.0V	-40°C ~ +85°C	SOT-89
CM2830AGHIN92	2.2V	-40°C ~ +85°C	TO-92
CM2830AGHIM23	2.2V	-40°C ~ +85°C	SOT-23-3
CM2830AGHIM89	2.2V	-40°C ~ +85°C	SOT-89
CM2830AGKIN92	2.5V	-40°C ~ +85°C	TO-92
CM2830AGKIM23	2.5V	-40°C ~ +85°C	SOT-23-3
CM2830AGKIM89	2.5V	-40°C ~ +85°C	SOT-89
CM2830AGMIN92	2.7V	-40°C ~ +85°C	TO-92
CM2830AGMIM23	2.7V	-40°C ~ +85°C	SOT-23-3
CM2830AGMIM89	2.7V	-40°C ~ +85°C	SOT-89
CM2830AGNIN92	2.8V	-40°C ~ +85°C	TO-92
CM2830AGNIM23	2.8V	-40°C ~ +85°C	SOT-23-3
CM2830AGNIM89	2.8V	-40°C ~ +85°C	SOT-89
CM2830AGOIN92	2.9V	-40°C ~ +85°C	TO-92
CM2830AGOIM23	2.9V	-40°C ~ +85°C	SOT-23-3
CM2830AGOIM89	2.9V	-40°C ~ +85°C	SOT-89
CM2830AGPIN92	3.0V	-40°C ~ +85°C	TO-92
CM2830AGPIM23	3.0V	-40°C ~ +85°C	SOT-23-3
CM2830AGPIM89	3.0V	-40°C ~ +85°C	SOT-89
CM2830AGSIN92	3.3V	-40°C ~ +85°C	TO-92
CM2830AGSIM23	3.3V	-40°C ~ +85°C	SOT-23-3
CM2830AGSIM89	3.3V	-40°C ~ +85°C	SOT-89
CM2830AGUIN92	3.5V	-40°C ~ +85°C	TO-92
CM2830AGUIM23	3.5V	-40°C ~ +85°C	SOT-23-3
CM2830AGUIM89	3.5V	-40°C ~ +85°C	SOT-89
CM2830AGVIN92	3.6V	-40°C ~ +85°C	TO-92
CM2830AGVIM23	3.6V	-40°C ~ +85°C	SOT-23-3
CM2830AGVIM89	3.6V	-40°C ~ +85°C	SOT-89
CM2830AGXIN92	3.8V	-40°C ~ +85°C	TO-92
CM2830AGXIM23	3.8V	-40°C ~ +85°C	SOT-23-3
CM2830AGXIM89	3.8V	-40°C ~ +85°C	SOT-89

Note: For other pre-set output voltage, please contact Champion Sales office.

ABSOLUTE MAXIMUM RATINGS

Input Voltage +7V
 Output Current $P_D / (V_{IN} - V_o)$
 Output Voltage GND-0.3V to $V_{IN}+0.3V$
 ESD Classification B

OPERATING RATINGS

Ambient Temperature Range (T_A) -40°C to +85°C
 Junction Temperature Range -40°C to +125°C

THERMAL INFORMATION

Parameter		Maximum	Unit
Thermal Resistance (θ_{jc})	SOT-23-3	170	°C/W
	SOT-23-5	160	
	SOT-89	100	
	TO-92	100	
Thermal Resistance (θ_{ja})	SOT-23-3	330	°C/W
	SOT-23-5	320	
	SOT-89	300	
	TO-92	300	
Internal Power Dissipation (P_D) ($\Delta T = 100^\circ\text{C}$)	SOT-23-3	225	mW
	SOT-23-5	250	
	SOT-89 (CM2830)	500	
	SOT-89 (CM2830A)	400	
	TO-92	500	
Maximum Junction Temperature		150	°C
Maximum Lead Temperature (10 Sec)		300	°C

*With Junction sink capable of twice times of θ_{jc}

Caution: Stress above the listed absolute rating may cause permanent damage to the device.

ELECTRICAL CHARACTERISTICS

T_A = +25°C; unless otherwise noted

Parameter	Test Conditions	CM2830/CM2830A			Unit
		Min.	Typ.	Max.	
Input Voltage		Note 1		7	V
Output Voltage Accuracy	I _o = 1mA	-1.5		1.5	%
Dropout Voltage	I _o = 300mA, V _{OUT} =V _{O(NOM)} -1.5%,	1.2V<V _{O(NOM)} <=2.0V		1300	mV
		2.0V<V _{O(NOM)} <=2.5V		800	
		2.5V<V _{O(NOM)}		300	
Output Current	V _{OUT} > 1.2V	300			mA
Short Circuit Current	V _{OUT} < 1.05V		150	300	mA
Current Limit	V _{OUT} >1.2V	300	450		mA
Quiescent Current	V _{IN} =5V, No Load		30	35	μ A
Ground Pin Current	I = 1mA to 300mA		30	35	μ A
Line Regulation	I _{OUT} =5mA, V _{IN} =V _{OUT} +1 to V _{OUT} +2, V _{OUT} <= 3.0V	-0.15	0.03	0.15	%
	I _{OUT} =5mA, V _{IN} =V _{OUT} +1 to V _{OUT} +2, V _{OUT} > 3.0V	-0.3	0.06	0.3	
Load Regulation	I _o =1mA to 300mA	-1	0.2	1	%
Power Supply Rejection	I _o = 100mA C _O =2.2 μ F ceramic	f=1KHz		60	dB
		f=10KHz		50	
		f=100KHz		40	
Over Temperature Shutdown			150		°C
Over Temperature Hysteresis			30		°C
Output Noise	F=10Hz to 100kHz, C _O =2.2 μ F, I _o = 10mA		30		μ Vrms
Output Voltage Temp. Coeff.			25		ppm/°C

Note 1. V_{IN(MIN)} = V_{OUT} + V_{DROPOUT}

DETAILED DESCRIPTION

The CM2830/CM2830A family of CMOS regulators contain a PMOS pass transistor, voltage reference, error amplifier, over-current protection, thermal shutdown, and short circuit protection.

The P-channel pass transistor receives data from the error amplifier, over-current shutdown, short output protection, and thermal protection circuits. During normal operation, the error amplifier compares the output voltage to a precision reference. Over-current and Thermal shutdown circuits become active when the junction temperature exceeds 150°C, or the current exceeds 300mA. During thermal shutdown, the output voltage remains low. Normal operation is restored when the junction temperature drops below 120°C.

The CM2830/CM2830A switches from voltage mode to current mode when the load exceeds the rated output current. This prevents over-stress. The CM2830 also incorporates current fold-back to reduce power dissipation when the output is short-circuited. This feature becomes active when the output drops below 1.05V, and reduces the current flow by 65%. Full current is restored when the voltage exceeds 1.05V.

EXTERNAL CAPACITOR

The CM2830/2830A is stable with an output capacitor to ground of 2.2 μ F or greater. It can keep stable even with higher or poor ESR capacitors. A second capacitor is recommended between the input and ground to stabilize V_{IN}. The input capacitor should be larger than 0.1 μ F to have a beneficial effect. All capacitors should be placed in close proximity to the pins. A "quiet" ground termination is desirable.

TYPICAL ELECTRICAL CHARACTERISTICS

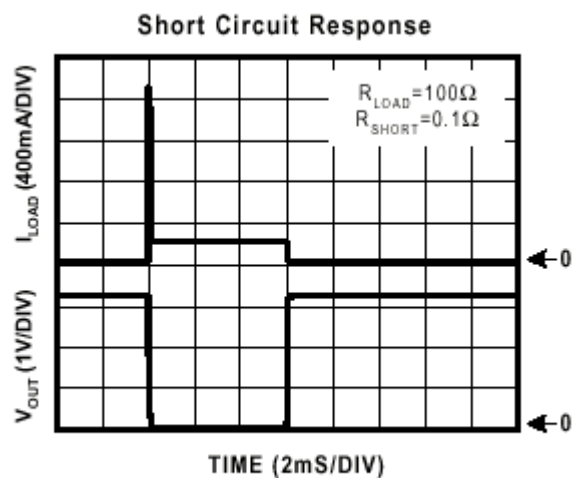
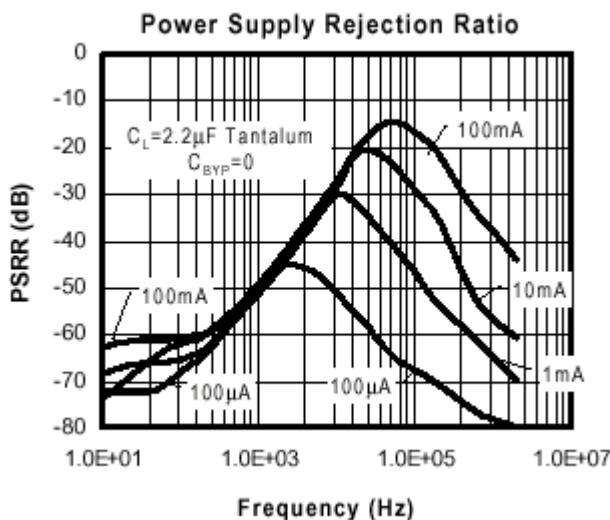
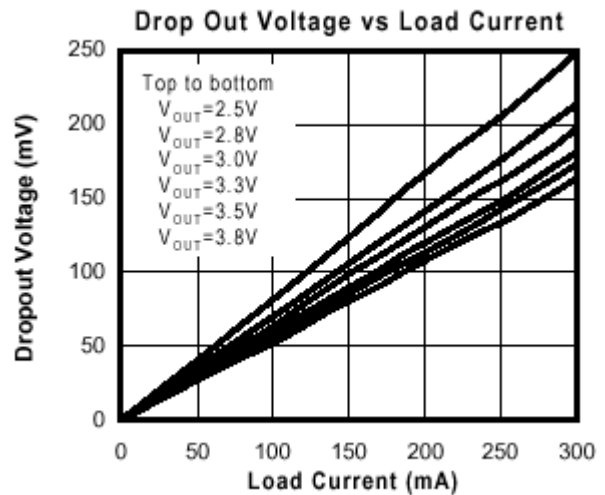
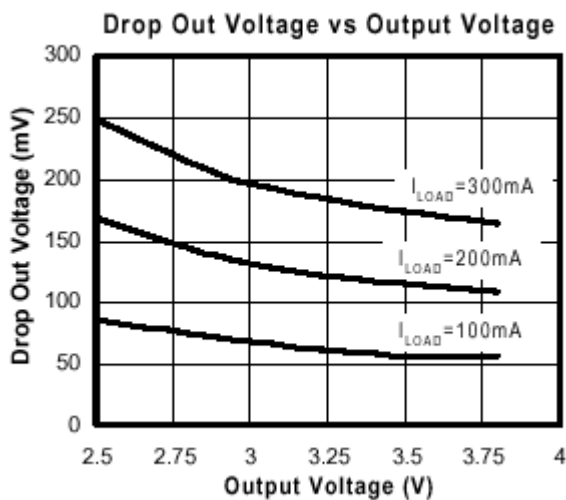
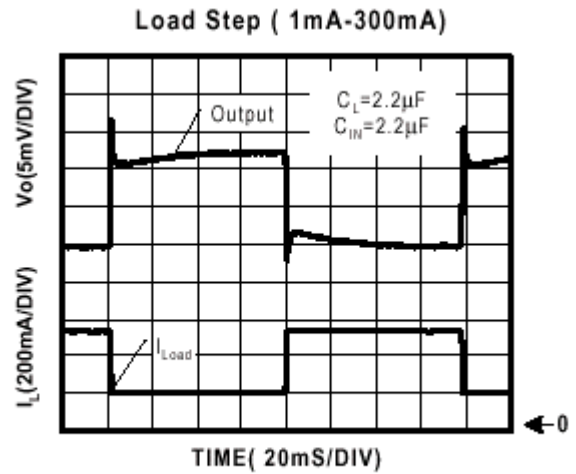
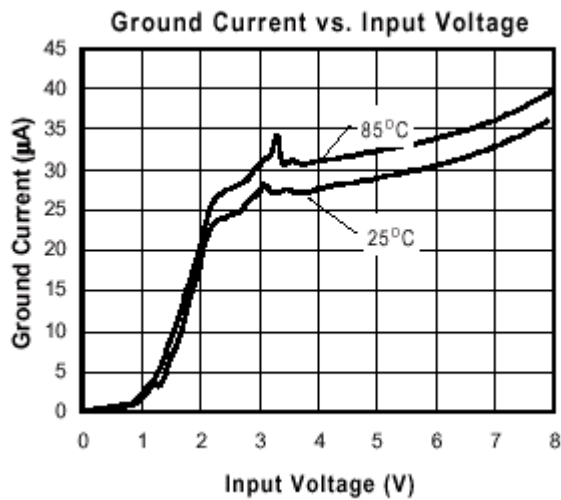

Overtemperature Shutdown

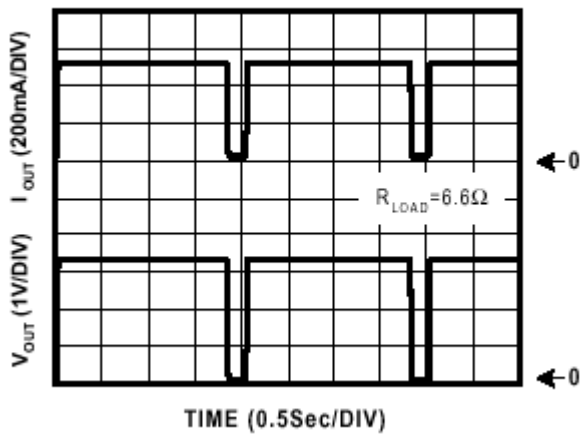

Current Limit Response

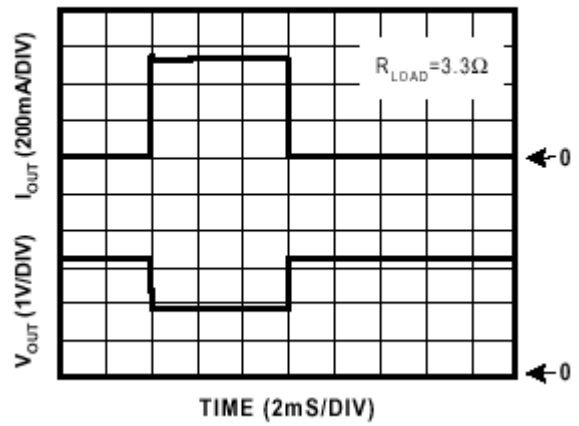

Noise Measurement

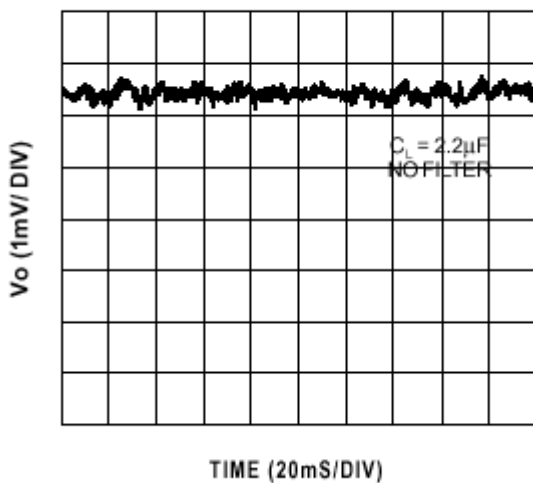

Transient Line Response

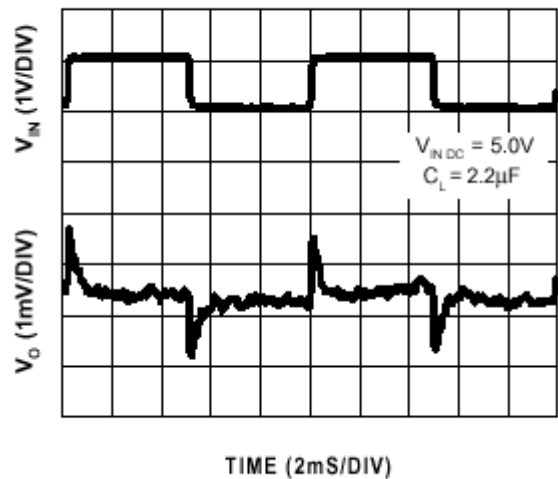

Safe Operating Area

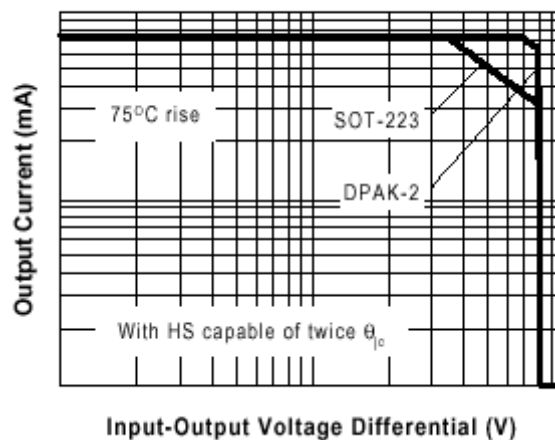

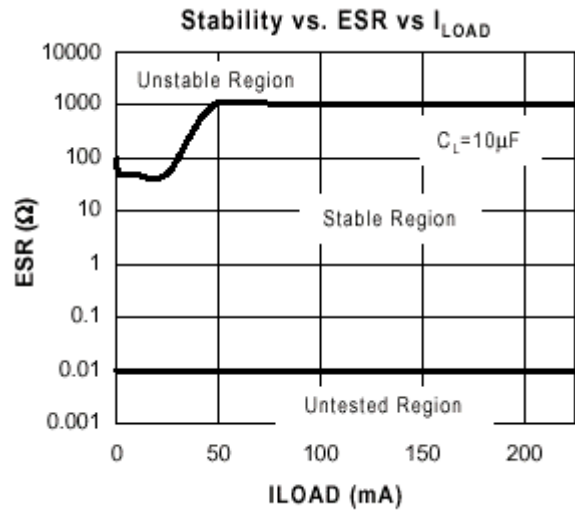
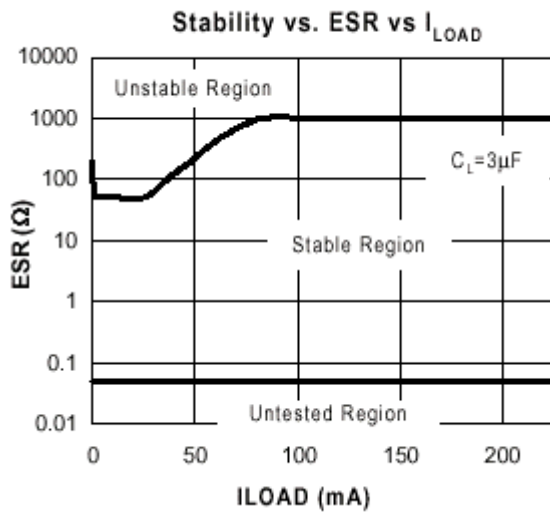
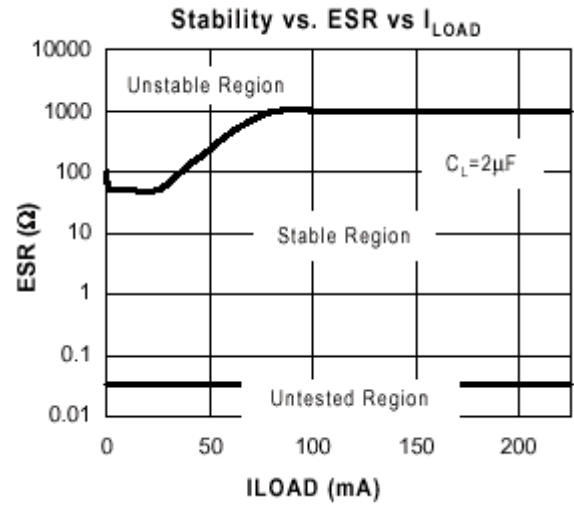
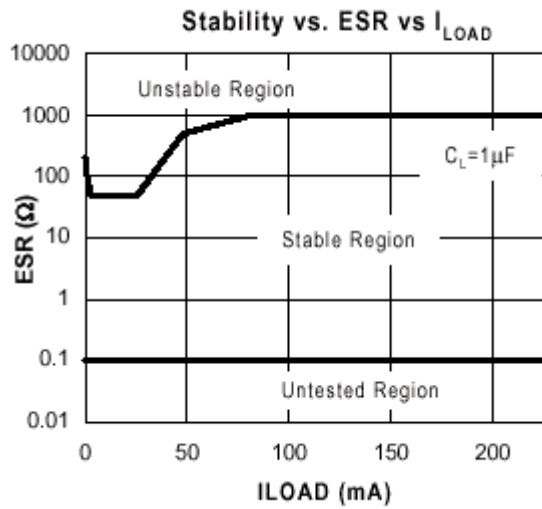

PACKAGE DIMENSION

TO-92 (N92)



SYMBOLS	DIMENSIONS IN MILLIMETERS			DIMENSIONS IN INCHES		
	MIN	NOM	MAX	MIN	NOM	MAX
A	3.45	3.56	3.66	0.136	0.140	0.144
A1	1.22	1.30	1.37	0.048	0.051	0.054
b	---	0.38	---	---	0.015	---
D	4.27	4.52	4.78	0.168	0.178	0.188
D1	4.14	4.29	4.45	0.163	0.169	0.175
E	4.32	4.57	4.83	0.170	0.180	0.190
L	12.98	13.49	14.00	0.511	0.531	0.551
e	---	1.27	---	---	0.050	---
theta	---	5°	---	---	5°	---
theta1	---	5°	---	---	5°	---

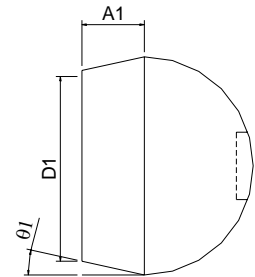
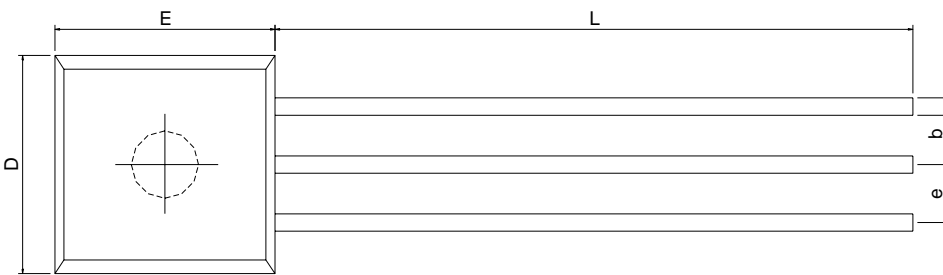

SOT-23-3 (M23)

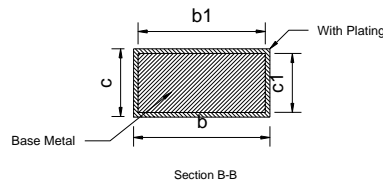
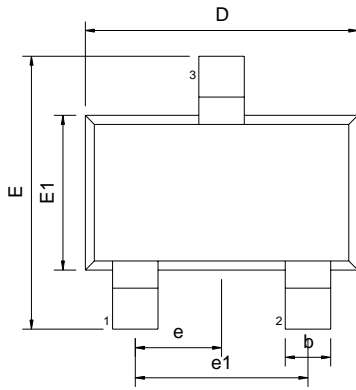

SYMBOLS	DIMENSIONS IN MILLIMETERS			DIMENSIONS IN INCHES		
	MIN	NOM	MAX	MIN	NOM	MAX
A	1.05	---	1.35	0.041	---	0.053
A1	0.05	---	0.15	0.002	---	0.006
A2	1.00	1.10	1.20	0.039	0.043	0.047
b	0.25	---	0.50	0.010	---	0.020
b1	0.25	0.40	0.45	0.010	0.016	0.018
c	0.08	---	0.20	0.003	---	0.008
c1	0.08	0.11	0.15	0.003	0.004	0.006
D	2.70	2.90	3.00	0.106	0.114	0.118
E	2.60	2.80	3.00	0.102	0.110	0.118
E1	1.50	1.60	1.70	0.059	0.063	0.067
L	0.35	0.45	0.55	0.014	0.018	0.022
L1	0.60 REF			0.024 REF		
e	0.95 BSC			0.037 BSC		
e1	1.90 BSC			0.075 BSC		
theta	0°	5°	10°	0°	5°	10°
theta1	3°	5°	7°	3°	5°	7°
theta2	6°	8°	10°	6°	8°	10°

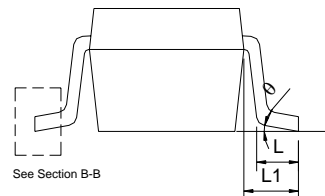
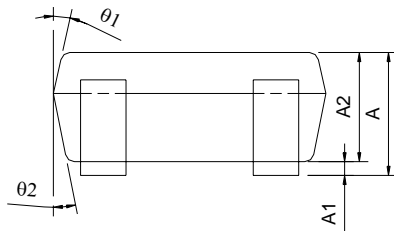

PACKAGE DIMENSION (CONTINUED)

SOT-23-5 (M25)

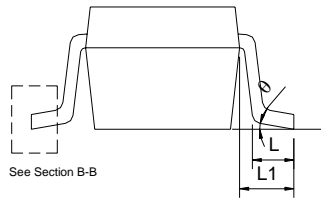
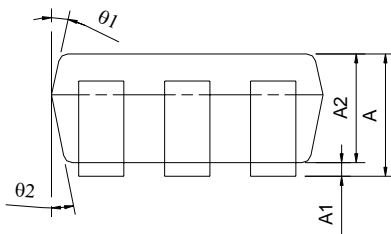
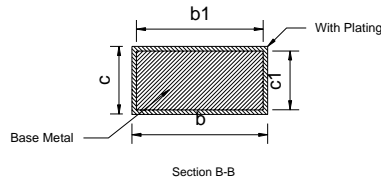
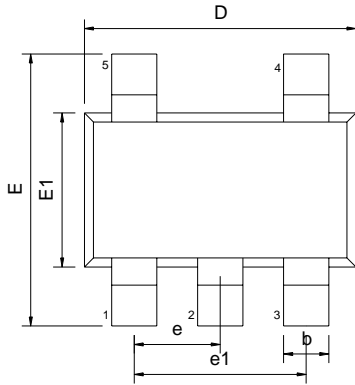

SYMBOLS	DIMENSIONS IN MILLIMETERS			DIMENSIONS IN INCHES		
	MIN	NOM	MAX	MIN	NOM	MAX
A	1.05	---	1.35	0.041	---	0.053
A1	0.05	---	0.15	0.002	---	0.006
A2	1.00	1.10	1.20	0.039	0.043	0.047
b	0.25	---	0.50	0.010	---	0.020
b1	0.25	0.40	0.45	0.010	0.016	0.018
c	0.08	---	0.20	0.003	---	0.008
c1	0.08	0.11	0.15	0.003	0.004	0.006
D	2.70	2.90	3.00	0.106	0.114	0.118
E	2.60	2.80	3.00	0.102	0.110	0.118
E1	1.50	1.60	1.70	0.059	0.063	0.067
L	0.35	0.45	0.55	0.014	0.018	0.022
L1	0.60 REF			0.024 REF		
e	0.95 BSC			0.037 BSC		
e1	1.90 BSC			0.075 BSC		
theta	0°	5°	10°	0°	5°	10°
theta1	3°	5°	7°	3°	5°	7°
theta2	6°	8°	10°	6°	8°	10°

SOT-89 (M89)

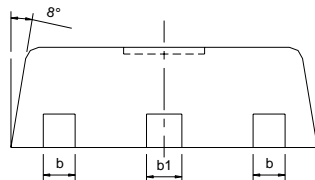
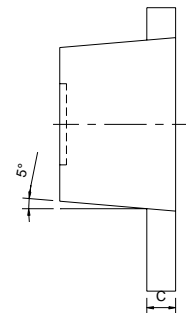
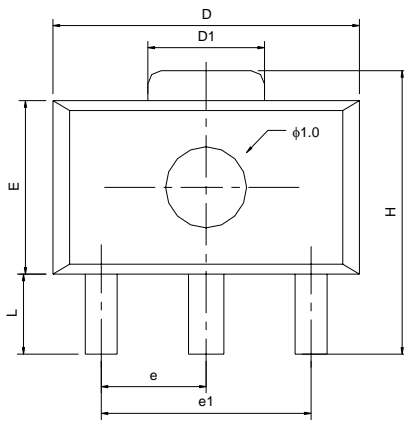

SYMBOLS	DIMENSIONS IN MILLIMETERS			DIMENSIONS IN INCHES		
	MIN	NOM	MAX	MIN	NOM	MAX
A	1.40	1.50	1.60	0.055	0.059	0.063
L	0.80	---	1.20	0.031	---	0.047
b	0.36	0.42	0.48	0.014	0.016	0.018
b1	0.41	0.47	0.53	0.016	0.018	0.020
C	0.38	0.40	0.43	0.014	0.015	0.017
D	4.40	4.50	4.60	0.173	0.177	0.181
D1	1.40	1.60	1.75	0.055	0.062	0.069
H	3.94	---	4.25	0.155	---	0.167
E	2.40	2.50	2.60	0.094	0.098	0.102
e1	2.90	3.00	3.10	0.114	0.118	0.122
e	1.45	1.50	1.55	0.057	0.059	0.061

NUMBERING SCHEME

Ordering Number: CM2830XYZ/CM2830AXYZ (note1)

Ordering Number: CM2830GXYZ/CM2830AGXYZ (note2)

note1:

CM2830/CM2830A : 300mA CMOS LDO
X : Suffix for voltage output (note 3)
Y : Suffix for Temperature Range (note 4)
Z : Suffix for Package Type (note 5)

note2:

CM2830/CM2830A : 300mA CMOS LDO
G : Suffix for Pb Free Product
X : Suffix for voltage output (note 3)
Y : Suffix for Temperature Range (note 4)
Z : Suffix for Package Type (note 5)

note 3: see CMOS LDO Voltage Suffix Table

CM2830/A will provide options of A (1.5V), D(1.8V), E (1.9V), F(2.0V), H (2.2V), K(2.5V), M(2.7V), N(2.8V), O (2.9V), P(3.0V), S(3.3V), U(3.5V), V(3.6V), X(3.8V)

note 4:

Y= I : -40°C ~+85°C (only I grade support for all CMOS LDOs)

note 5:

Z is single alphabet with or without digits
M23 : SOT-23 (TR only)
N92 : TO-92 (TA only)
M25 : SOT-25 (TR only)
M89 : SOT-89 (TR only)

CMOS LDO Voltage Suffix Table

Output Voltage	Suffix	Output Voltage	Suffix
1.5V	A	3.0V	P
1.6V	B	3.1V	Q
1.7V	C	3.2V	R
1.8V	D	3.3V	S
1.9V	E	3.4V	T
2.0V	F	3.5V	U
2.1V	G	3.6V	V
2.2V	H	3.7V	W
2.3V	I	3.8V	X
2.4V	J	3.9V	Y
2.5V	K	4.0V	Z
2.6V	L		
2.7V	M		
2.8V	N		
2.9V	O		

IMPORTANT NOTICE

Champion Microelectronic Corporation (CMC) reserves the right to make changes to its products or to discontinue any integrated circuit product or service without notice, and advises its customers to obtain the latest version of relevant information to verify, before placing orders, that the information being relied on is current.

A few applications using integrated circuit products may involve potential risks of death, personal injury, or severe property or environmental damage. CMC integrated circuit products are not designed, intended, authorized, or warranted to be suitable for use in life-support applications, devices or systems or other critical applications. Use of CMC products in such applications is understood to be fully at the risk of the customer. In order to minimize risks associated with the customer's applications, the customer should provide adequate design and operating safeguards.

HsinChu Headquarter

5F, No. 11, Park Avenue II,
Science-Based Industrial Park,
HsinChu City, Taiwan
TEL: +886-3-567 9979
FAX: +886-3-567 9909

Sales & Marketing

11F, No. 306-3, SEC. 1, Ta Tung Road,
Hsichih, Taipei Hsien 221, Taiwan
TEL: +886-2-8692 1591
FAX: +886-2-8692 1596
