

DATA SHEET

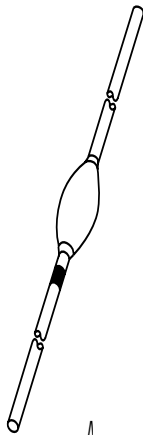

BY505

High-voltage soft-recovery rectifier

Product specification
Supersedes data of May 1996

1996 Sep 26

High-voltage soft-recovery rectifier

BY505

FEATURES

- Glass passivated
- High maximum operating temperature
- Low leakage current
- Excellent stability
- Soft-recovery switching characteristics
- Compact construction.

APPLICATIONS

- High-voltage applications for:
 - High frequencies
 - Switching applications.

DESCRIPTION

Rugged glass package, using a high temperature alloyed construction. This package is hermetically sealed and fatigue free as coefficients of

expansion of all used parts are matched.

The package is designed to be used in an insulating medium such as resin, oil or SF6 gas.

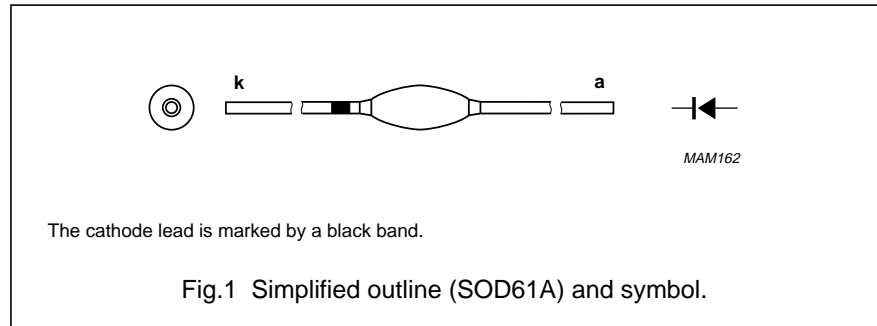

LIMITING VALUES

In accordance with the Absolute Maximum Rating System (IEC 134).

SYMBOL	PARAMETER	CONDITIONS	MIN.	MAX.	UNIT
V_{RSM}	non-repetitive peak reverse voltage		–	2200	V
V_{RRM}	repetitive peak reverse voltage		–	2200	V
V_{RW}	working reverse voltage		–	2000	V
$I_{F(AV)}$	average forward current	averaged over any 20 ms period; $T_{tp} = 25\text{ °C}$; lead length = 10 mm; see Fig.2; see also Fig.4	–	85	mA
		averaged over any 20 ms period; $T_{amb} = 60\text{ °C}$; PCB mounting (see Fig.6); see Fig.3; see also Fig.4	–	50	mA
I_{FRM}	repetitive peak forward current		–	800	mA
I_{FSM}	non-repetitive peak forward current	$t \leq 10\text{ ms}$; half sinewave; $T_j = T_{jmax}$ prior to surge; $V_R = V_{RWmax}$	–	5	A
T_{stg}	storage temperature		–65	+120	°C
T_j	junction temperature		–65	+120	°C

High-voltage soft-recovery rectifier

BY505

ELECTRICAL CHARACTERISTICS $T_j = 25\text{ }^\circ\text{C}$; unless otherwise specified.

SYMBOL	PARAMETER	CONDITIONS	MIN.	TYP.	MAX.	UNIT
V_F	forward voltage	$I_F = 100\text{ mA}$; $T_j = T_{j\text{ max}}$; see Fig.5	–	–	8.5	V
I_R	reverse current	$V_R = V_{RW\text{ max}}$; $T_j = T_{j\text{ max}}$	–	–	3	μA
Q_r	recovery charge	when switched from $I_F = 100\text{ mA}$ to $V_R \geq 100\text{ V}$ and $dI_F/dt = -200\text{ mA}/\mu\text{s}$; see Fig.7	–	–	1	nC
t_f	fall time	when switched from $I_F = 100\text{ mA}$ to $V_R \geq 100\text{ V}$ and $dI_F/dt = -200\text{ mA}/\mu\text{s}$; see Fig.7	100	–	–	ns
t_{rr}	reverse recovery time	when switched from $I_F = 100\text{ mA}$ to $V_R \geq 100\text{ V}$ and $dI_F/dt = -200\text{ mA}/\mu\text{s}$; see Fig.7	–	200	–	ns
C_d	diode capacitance	$V_R = 0\text{ V}$; $f = 1\text{ MHz}$	–	2	–	pF

THERMAL CHARACTERISTICS

SYMBOL	PARAMETER	CONDITIONS	VALUE	UNIT
$R_{th\ j-tp}$	thermal resistance from junction to tie-point	lead length = 10 mm	100	K/W
$R_{th\ j-a}$	thermal resistance from junction to ambient	note 1	155	K/W

Note

1. Device mounted on epoxy-glass printed-circuit board, 1.5 mm thick; thickness of copper $\geq 40\text{ }\mu\text{m}$, see Fig.6. For more information please refer to the "General Part of associated Handbook".

High-voltage soft-recovery rectifier

BY505

GRAPHICAL DATA

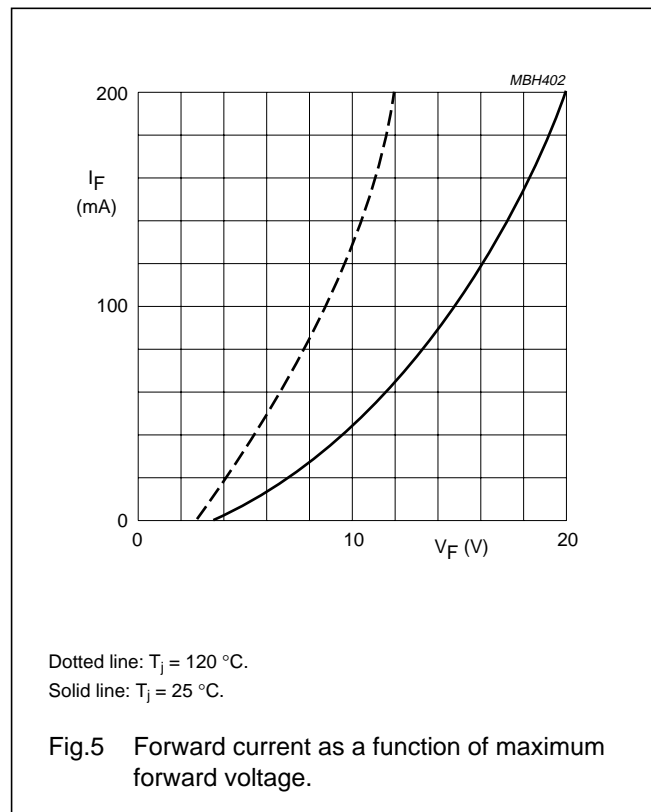
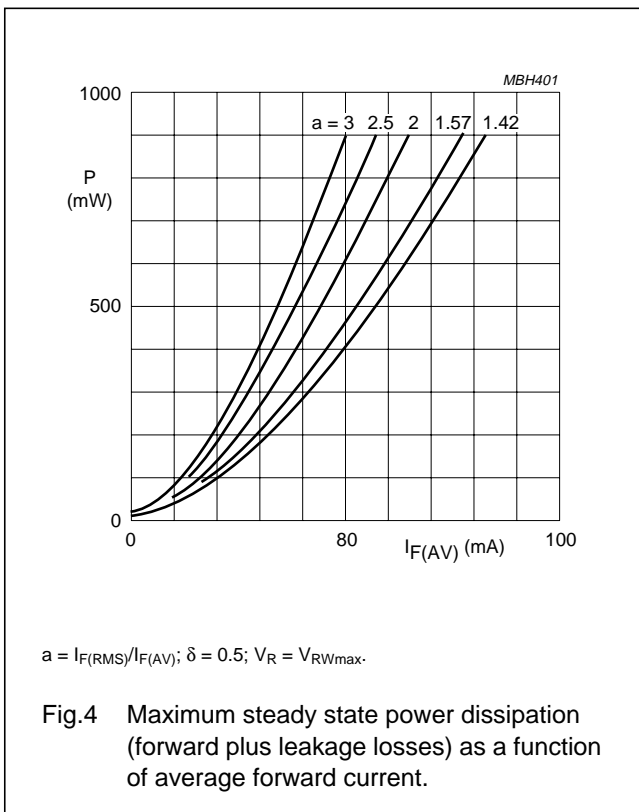
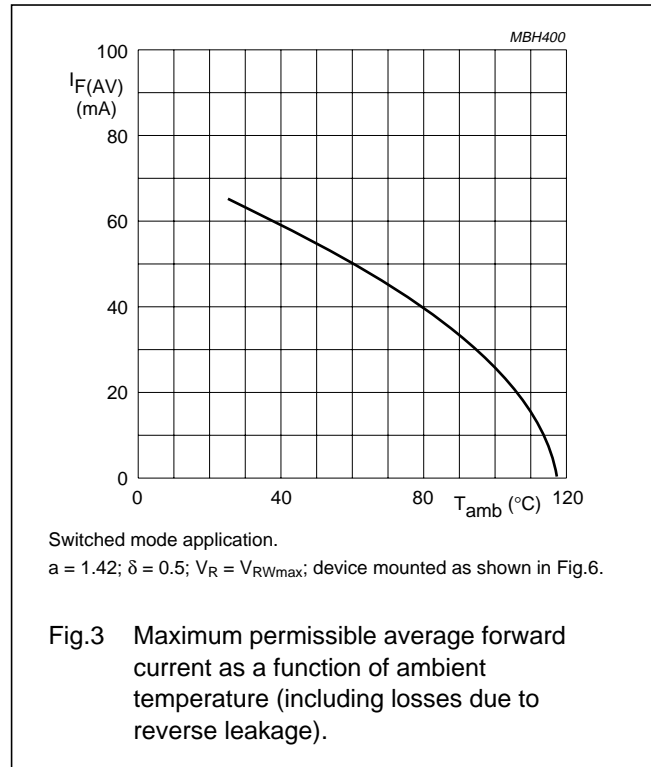
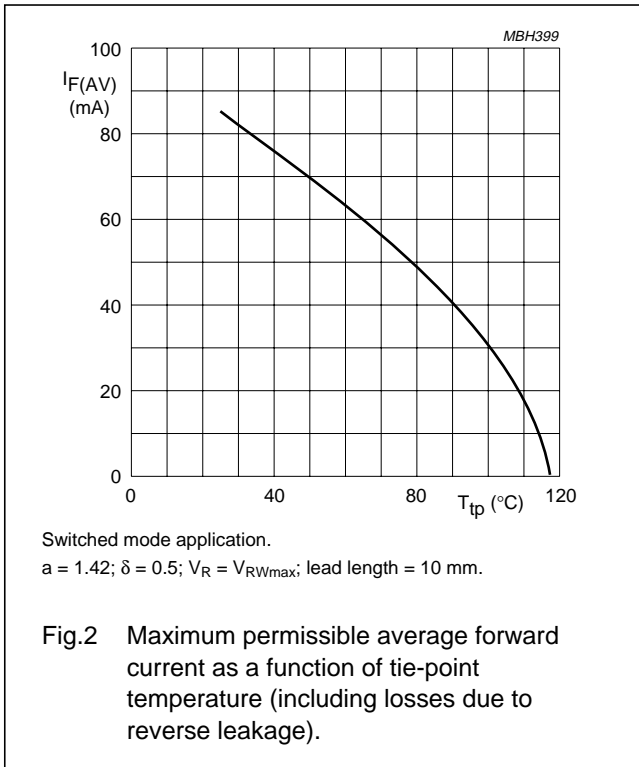

High-voltage soft-recovery rectifier

BY505

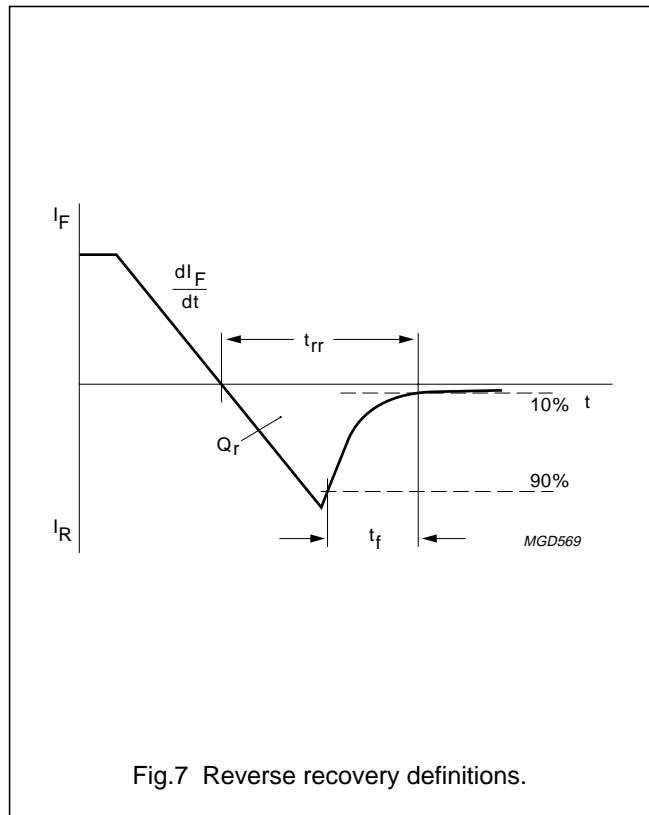
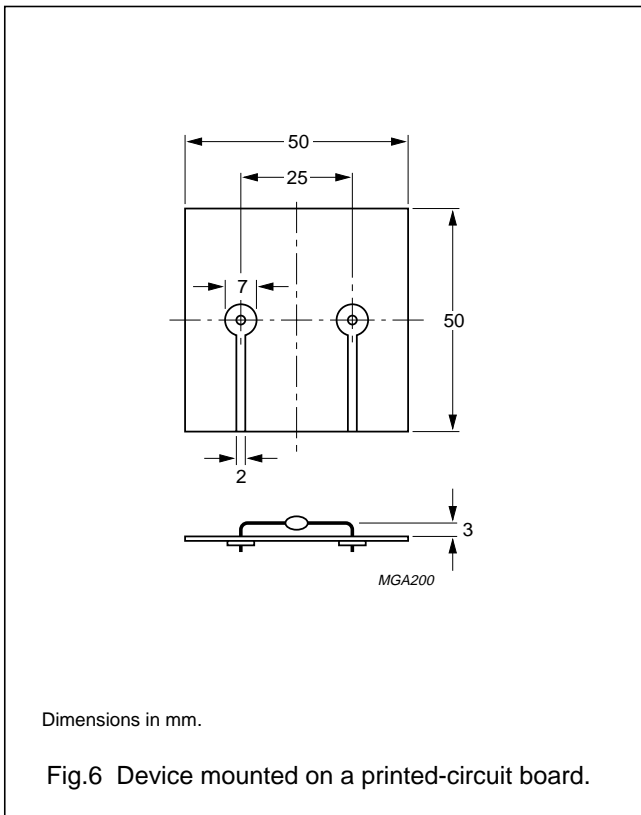

High-voltage soft-recovery rectifier

BY505

PACKAGE OUTLINE

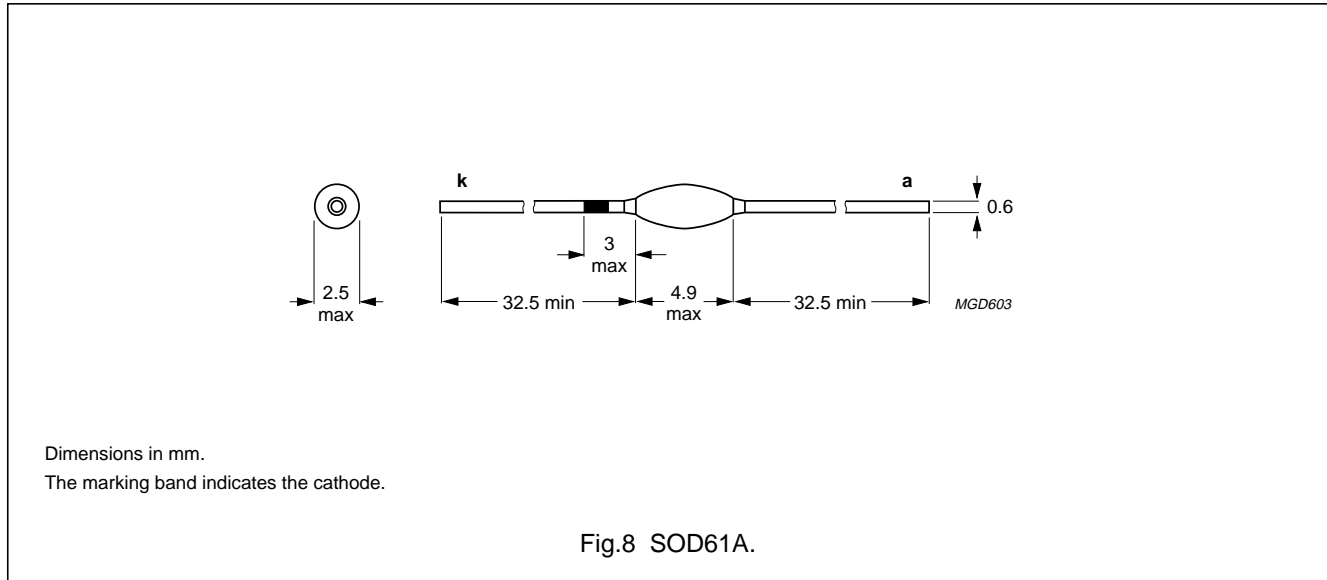

DEFINITIONS

Data Sheet Status	
Objective specification	This data sheet contains target or goal specifications for product development.
Preliminary specification	This data sheet contains preliminary data; supplementary data may be published later.
Product specification	This data sheet contains final product specifications.
Limiting values	
Limiting values given are in accordance with the Absolute Maximum Rating System (IEC 134). Stress above one or more of the limiting values may cause permanent damage to the device. These are stress ratings only and operation of the device at these or at any other conditions above those given in the Characteristics sections of the specification is not implied. Exposure to limiting values for extended periods may affect device reliability.	
Application information	
Where application information is given, it is advisory and does not form part of the specification.	

LIFE SUPPORT APPLICATIONS

These products are not designed for use in life support appliances, devices, or systems where malfunction of these products can reasonably be expected to result in personal injury. Philips customers using or selling these products for use in such applications do so at their own risk and agree to fully indemnify Philips for any damages resulting from such improper use or sale.