

# 技术参数 SPECIFICATIONS

线数 ( Poles ) : 2~20

适用线规 ( Applicable wires ) : AWG26#~22#

适用基板厚度 ( Applicable PC board thickness ) : 1.6mm

温度范围 ( Temperature range ) : -40°C ~ +105°C

额定电压 ( Voltage rating ) : 250V.Ac/Dc

额定电流 ( Current rating ) : 3A

接触电阻 ( Contact resistance ) :  $\leq 0.02\Omega$

绝缘电阻 ( Insulation resistance ) :  $\geq 1000M\Omega$

耐压 ( Withstand voltage ) : 1000V.Ac/1分钟 ( Minute )

材料 ( Material ) :

孔座 ( Housing ) : 尼龙 ( Nylon ) UL94V-0

针座 ( Wafer ) : 尼龙 ( Nylon ) UL94V-0

端子 ( Terminal ) : 磷青铜 ( Phos.bronze Tin/plated )

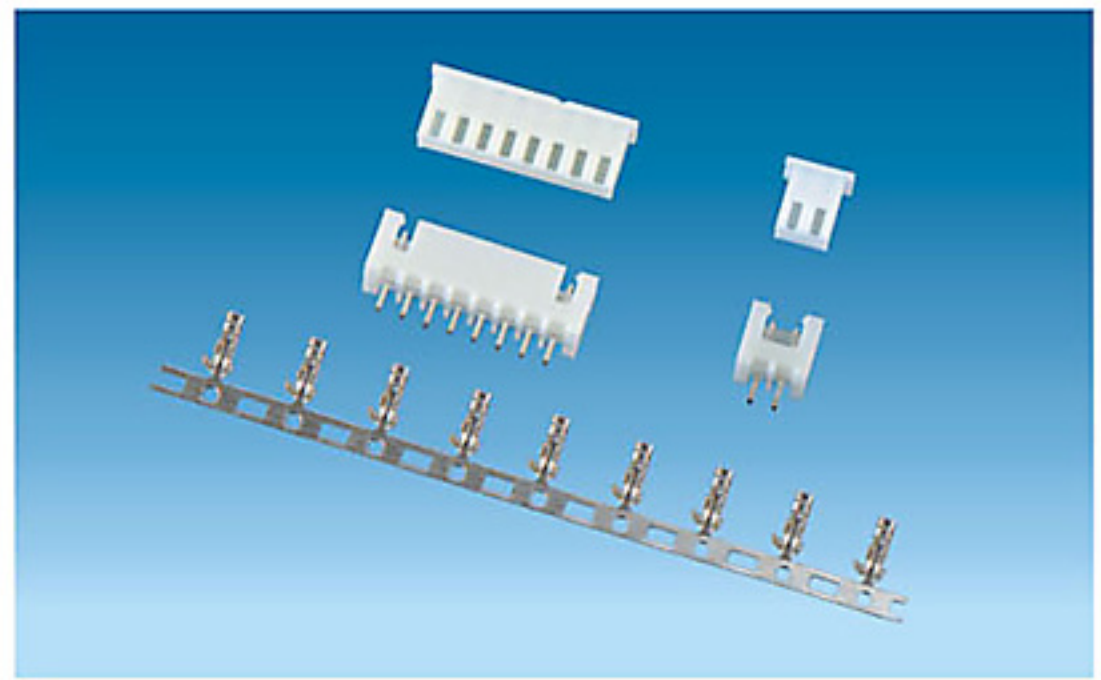

## 端子 TERMINAL(XH)

型号 Type	适用线规 Applicable wires		电线外径 O.D of wire ins
	mm <sup>2</sup>	AWG#	mm
KF25002-PT	0.08-0.33	28-22	1.2-1.9

### KF25002-PT(XH)

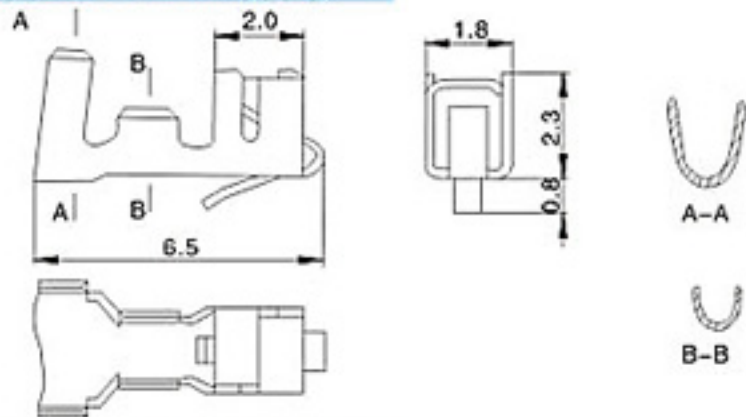

### KF25002-Y(XH)

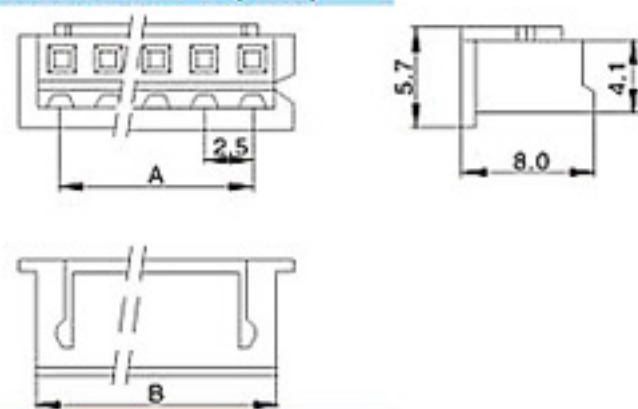

### KF25002-A(XH)

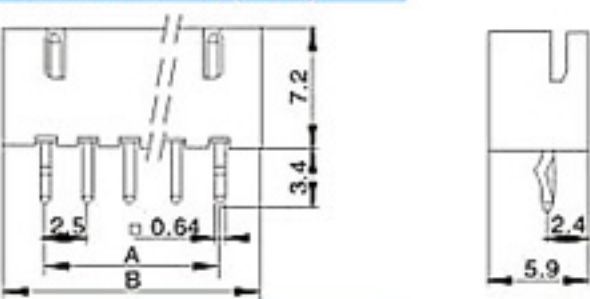

### KF25003-WAP1(XH)

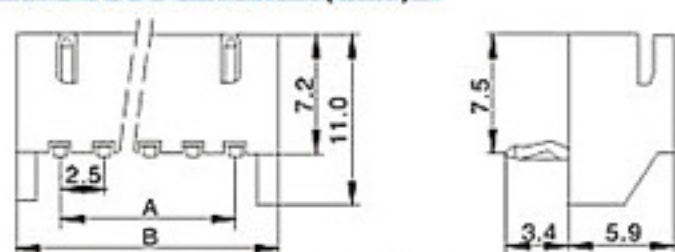

### KF25003-WAP2(XH)



## KF25003-WAG(XH)

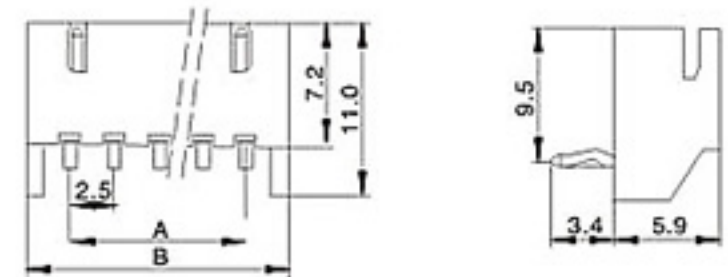

## 安装尺寸 MOUNTING MEASUREMENT

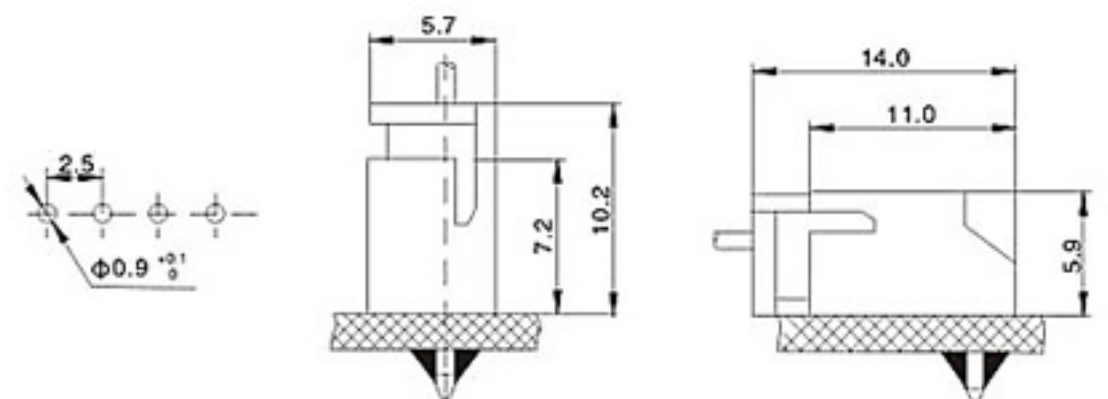

## 孔座 HOUSING(XH)

线数 Poles	型号 Type	尺寸Dimensions(mm)	
		A	B
2	KF25002-2Y	2.5	5.7
3	KF25002-3Y	5.0	8.2
4	KF25002-4Y	7.5	10.7
5	KF25002-5Y	10.0	13.2
6	KF25002-6Y	12.5	15.7
7	KF25002-7Y	15.0	18.2
8	KF25002-8Y	17.5	20.7
9	KF25002-9Y	20.0	23.2
10	KF25002-10Y	22.5	25.7
11	KF25002-11Y	25.0	28.2
12	KF25002-12Y	27.5	30.7
13	KF25002-13Y	30.0	36.22
14	KF25002-14Y	32.5	33.2
15	KF25002-15Y	35.0	35.7
16	KF25002-16Y	37.5	38.2
17	KF25002-17Y	40.0	40.7
18	KF25002-18Y	42.5	43.2
19	KF25002-19Y	45.0	45.7
20	KF25002-20Y	47.5	50.7

## 针座 WAFER (XH)

线数 Poles	型号Type		尺寸Dimensions(mm)	
	直式(180°)	弯式(90°)	A	B
2	KF25003-2A	KF25003-2WA	2.5	7.4
3	KF25003-3A	KF25003-3WA	5.0	9.9
4	KF25003-4A	KF25003-4WA	7.5	12.4
5	KF25003-5A	KF25003-5WA	10.0	14.9
6	KF25003-6A	KF25003-6WA	12.5	17.4
7	KF25003-7A	KF25003-7WA	15.0	19.9
8	KF25003-8A	KF25003-8WA	17.5	22.4
9	KF25003-9A	KF25003-9WA	20.0	24.9
10	KF25003-10A	KF25003-10WA	22.5	27.4
11	KF25003-11A	KF25003-11WA	25.0	29.9
12	KF25003-12A	KF25003-12WA	27.5	32.4
13	KF25003-13A	KF25003-13WA	30.0	34.9
14	KF25003-14A	KF25003-14WA	32.5	37.4
15	KF25003-15A	KF25003-15WA	35.0	39.9
16	KF25003-16A	KF25003-16WA	37.5	42.4
17	KF25003-17A	KF25003-17WA	40.0	44.9
18	KF25003-18A	KF25003-18WA	42.5	47.4
19	KF25003-19A	KF25003-19WA	45.0	49.9
20	KF25003-20A	KF25003-20WA	47.5	52.4