

SAB 8282A / SAB 8283A Octal Latch

- Fully compatible with SAB 8282/SAB 8283
- 40% Less Power Supply Current than Standard SAB 8282/SAB 8283
- Address Latch for SAB 80286, SAB 80186, SAB 8086, SAB 8085, SAB 8048 and SAB 8051 Families
- High Output Drive Capability for Driving System Data Bus
- Fully Parallel 8-Bit Data Register and Buffer
- No Output Low Noise when Entering or Leaving High Impedance State
- 3-State Outputs
- Transparent during Active Strobe
- 20-Pin Package

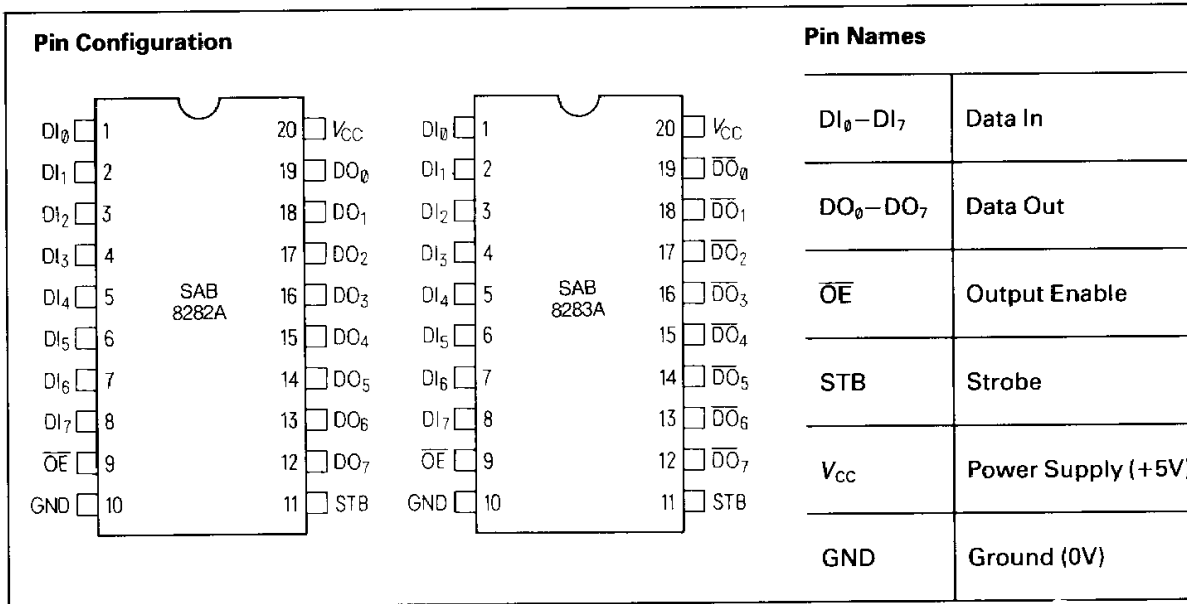

The SAB 8282A and SAB 8283A are 8-bit bipolar latches with 3-state output buffers. They can be used to implement latches, buffers, or multiplexers. The SAB 8283A inverts the input data at its outputs while the SAB 8282A does not.

Thus, all of the principal peripheral and input/output functions of a microcomputer system can be implemented with these devices. This device is fabricated in a fast bipolar ASBC (Advanced Standard Buried Collector) process of Siemens.

SAB 8282A / SAB 8283A

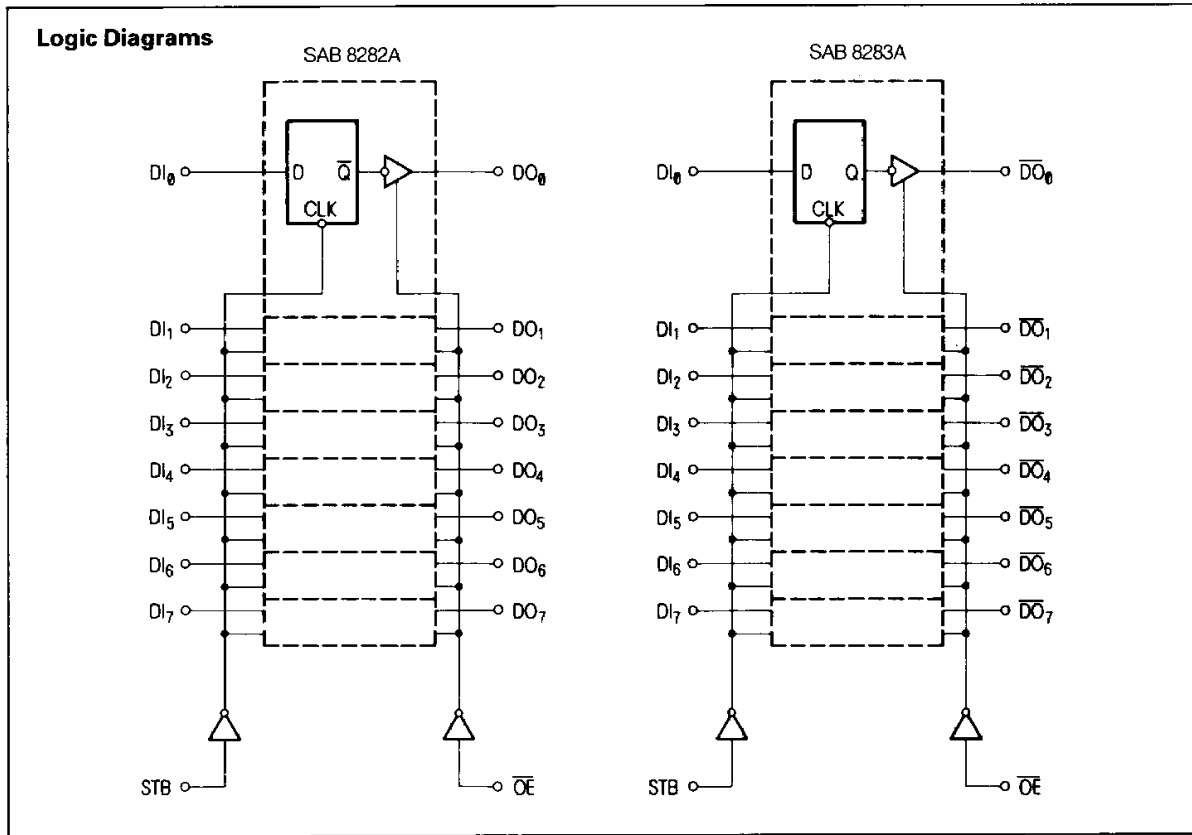

Pin Definitions and Functions

Symbol	Number	Input (I) Output (O)	Function
STB	11	I	STROBE – STB is an input control pulse used to strobe data at the data input pins (A_0 – A_7) into the data latches. This signal is active HIGH to admit input data. The data is latched at the HIGH to LOW transition of STB.
\overline{OE}	9	I	OUTPUT ENABLE – \overline{OE} is an input control signal which when active LOW enables the contents of the data latches onto the data output pin (DO_0 – DO_7 or $\overline{DO_0}$ – $\overline{DO_7}$). \overline{OE} being inactive HIGH forces the output buffers to their high impedance state.
DI_0 – DI_7	1–8	I	DATA INPUT PINS – Data presented at these pins satisfying setup time requirements when STB is strobed and latched into the data input latches.
DO_0 – DO_7 (SAB 8282A) $\overline{DO_0}$ – $\overline{DO_7}$ (SAB 8283A)	12–19	O	DATA OUTPUT PINS – When \overline{OE} is true, the data in the data latches is presented as inverted (SAB 8283A) or non-inverted (SAB 8282A) data onto the data output pins.
V_{CC}	20	–	Power Supply (+5V)
GND	10	–	Ground (0V)

Functional Description

The SAB 8282A and SAB 8283A octal latches are 8-bit latches with 3-state output buffers. Data having satisfied the setup time requirements is latched into the data latches by strobing the STB line HIGH to LOW. Holding the STB line in its active HIGH state makes the latches appear transparent.

Data is presented to the data output pins by activating the \overline{OE} input line. When \overline{OE} is inactive HIGH the output buffers are in their high impedance state. Enabling or disabling the output buffers will not cause negative-going transients to appear on the data output bus.

Absolute Maximum Ratings¹⁾

Temperature Under Bias	0 to +70°C
Storage Temperature	-65 to +150°C
All Output and Supply Voltages	-0.5 to +7V
All Input Voltages	-1.0 to +5.5V
Power Dissipation	1W

D. C. Characteristics

$T_A = 0$ to 70°C ; $V_{CC} = +5\text{V} \pm 10\%$

Symbol	Parameter	Limit Values		Units	Test Conditions
		Min.	Max.		
V_C	Input Clamp Voltage	-	-1	V	$I_C = -5$ mA
I_{CC}	Power Supply Current SAB 8282A SAB 8283A	-	100 90	mA	all outputs open
I_F	Forward Input Current	-	-0.2		$V_F = 0.45\text{V}$
I_R	Reverse Input Current	-	50	μA	$V_R = 5.25\text{V}$
V_{OL}	Output LOW Voltage	-	0.45	V	$I_{OL} = 32$ mA
V_{OH}	Output HIGH Voltage	2.4	-		$I_{OH} = -5$ mA
I_{OFF}	Output Off Current	-	± 50	μA	$V_{OFF} = 0.45$ to 5.25V
V_{IL}	Input LOW Voltage	-	0.8	V	$V_{CC} = 5.0\text{V}^{2)}$
V_{IH}	Input HIGH Voltage	2.0	-		
C_{IN}	Input Capacitance	-	12	pF	$F = 1$ MHz $V_{BIAS} = 2.5\text{V}$, $V_{CC} = 5\text{V}$ $T_A = 25^\circ\text{C}$

1) Stresses above those listed under "Absolute Maximum Ratings" may cause permanent damage to the device. Exposure to absolute maximum rating conditions for extended periods may affect device reliability.

2) Output Loading: $I_{OL} = 32$ mA; $I_{OH} = -5$ mA;
 $C_L = 300$ pF

SAB 8282A / SAB 8283A

A.C. Characteristics

$T_A = 0$ to $+70^\circ\text{C}$; $V_{CC} = +5\text{ V} \pm 10\%$

Loading

Outputs: $I_{OL} = 32\text{ mA}$; $I_{OH} = -5\text{ mA}$; $C_L = 300\text{ pF}$

Symbol	Parameter	Limit Values		Units	Test Conditions		
		Min.	Max.				
t_{VOV}	Input to Output Delay – Inverting – Non-Inverting	5 5	22 30	ns	2)		
t_{SHOV}	STB to Output Delay – Inverting – Non-Inverting	10 10	40 45				
t_{EHOZ}	Output Disable Time	5	18				
t_{ELOV}	Output Enable Time	10	30				
t_{IVSL}	Input to STB Setup Time	0	–				
t_{SLIX}	Input to STB Hold Time	25					
t_{SHSL}	STB HIGH Time	15					
t_{ILIH}, t_{OLOH}	Input, Output Rise Time	–	20				From 0.8 to 2.0V
t_{IHIL}, t_{OHOL}	Input, Output Fall Time	–	12				From 2.0 to 0.8V

A.C. Testing Input, Output Waveform

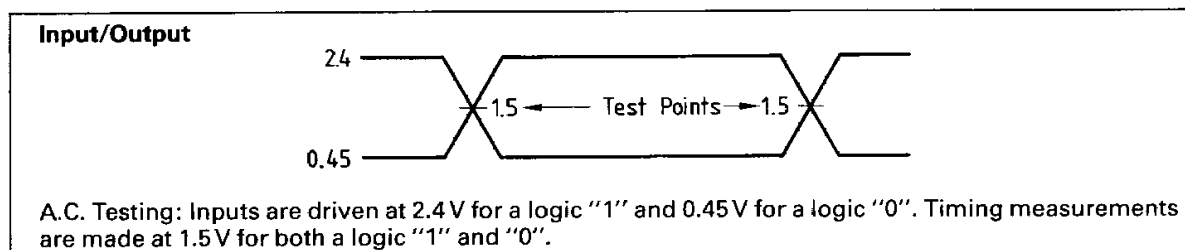

Waveforms

All timing measurements are made at 1.5V unless otherwise noted.

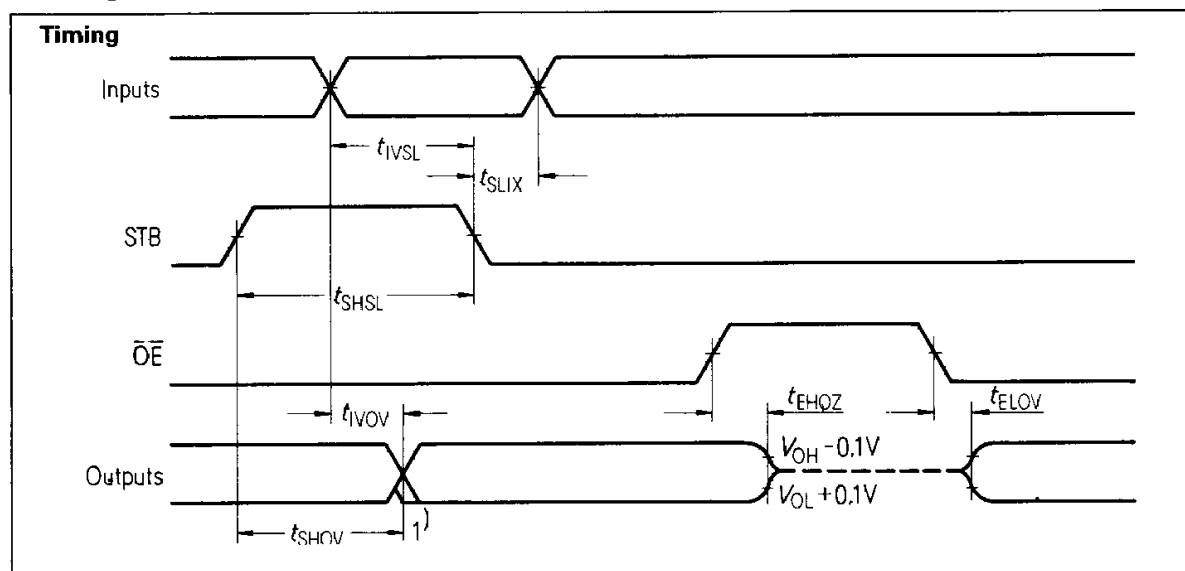

1) SAB 8283A Only – Output may be momentarily invalid following the high going STB transition.

2) See waveforms and test load circuit.

Output Test Load Circuits

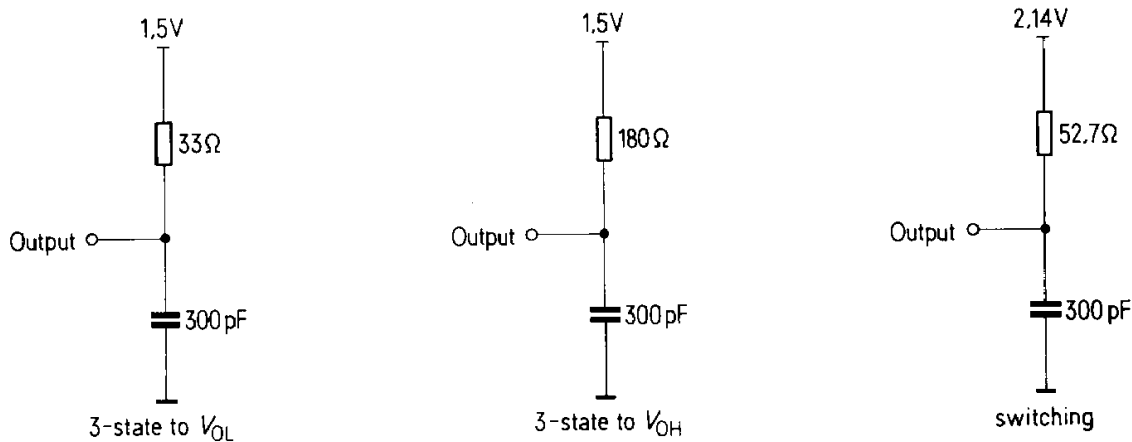

Output Delay vs. Capacitance

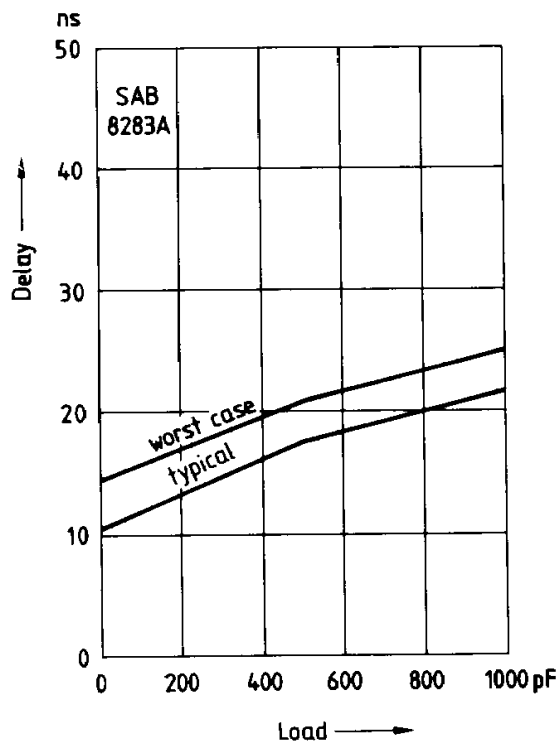
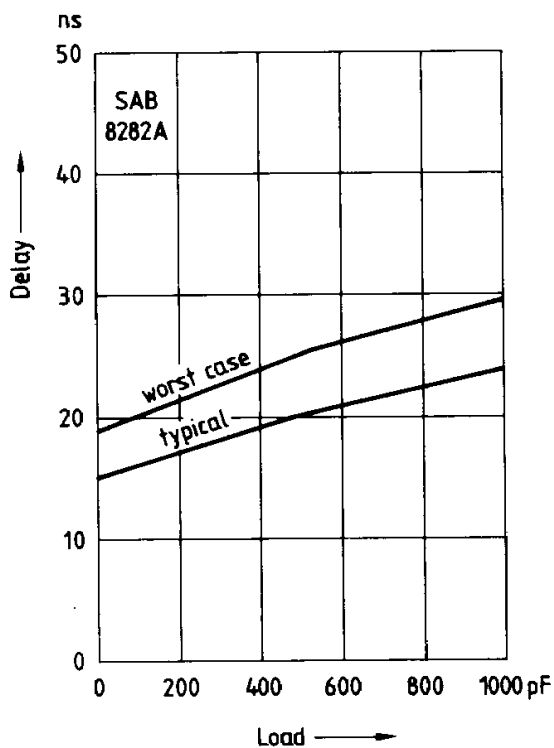

SAB 8282A / SAB 8283A

Ordering Information

Type	Description	Ordering code
SAB 8282A-P	Octal Latch, non inverting (plastic)	Q 67020-Y149
SAB 8283A-P	Octal Latch, inverting (plastic)	Q 67020-Y150