

## LMC6001 Ultra Ultra-Low Input Current Amplifier

### General Description

Featuring 100% tested input currents of 25 fA max., low operating power, and ESD protection of 2000V, the LMC6001 achieves a new industry benchmark for low input current operational amplifiers. By tightly controlling the molding compound, National is able to offer this ultra-low input current in a lower cost molded package.

To avoid long turn-on settling times common in other low input current opamps, the LMC6001A is tested 3 times in the first minute of operation. Even units that meet the 25 fA limit are rejected if they drift.

Because of the ultra-low input current noise of  $0.13 \text{ fA}/\sqrt{\text{Hz}}$ , the LMC6001 can provide almost noiseless amplification of high resistance signal sources. Adding only 1 dB at 100 k $\Omega$ , 0.1 dB at 1 M $\Omega$  and 0.01 dB or less from 10 M $\Omega$  to 2,000 M $\Omega$ , the LMC6001 is an almost noiseless amplifier.

The LMC6001 is ideally suited for electrometer applications requiring ultra-low input leakage such as sensitive photodetection transimpedance amplifiers and sensor amplifiers. Since input referred noise is only  $22 \text{ nV}/\sqrt{\text{Hz}}$ , the LMC6001

can achieve higher signal to noise ratio than JFET input type electrometer amplifiers. Other applications of the LMC6001 include long interval integrators, ultra-high input impedance instrumentation amplifiers, and sensitive electrical-field measurement circuits.

### Features

(Max limit, 25°C unless otherwise noted)

- Input current (100% tested): 25 fA
- Input current over temp.: 2 pA
- Low power: 750  $\mu\text{A}$
- Low  $V_{OS}$ : 350  $\mu\text{V}$
- Low noise:  $22 \text{ nV}/\sqrt{\text{Hz}}$  @1 kHz Typ.

### Applications

- Electrometer amplifier
- Photodiode preamplifier
- Ion detector
- A.T.E. leakage testing

### Connection Diagrams

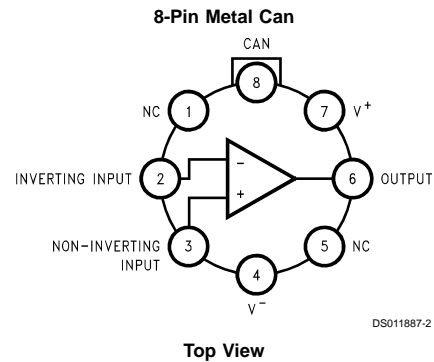
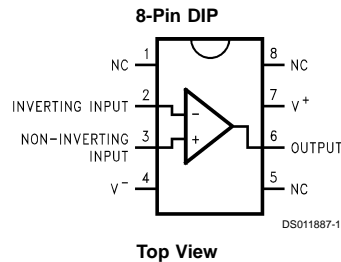

## Ordering Information

Package	Industrial Temperature Range -40°C to +85°C	NSC Package Drawing
8-Pin Molded DIP	LMC6001AIN, LMC6001BIN, LMC6001CIN	N08E
8-Pin Metal Can	LMC6001AIH, LMC6001BIH	H08C

## Absolute Maximum Ratings (Note 1)

If Military/Aerospace specified devices are required, please contact the National Semiconductor Sales Office/Distributors for availability and specifications.

Differential Input Voltage	$\pm$ Supply Voltage
Voltage at Input/Output Pin	$(V^+) + 0.3V, (V^-) - 0.3V$
Supply Voltage ( $V^+ - V^-$ )	-0.3V to +16V
Output Short Circuit to $V^+$	(Notes 2, 10)
Output Short Circuit to $V^-$	(Note 2)
Lead Temperature	
(Soldering, 10 Sec.)	260°C
Storage Temperature	-65°C to +150°C
Junction Temperature	150°C
Current at Input Pin	$\pm 10$ mA
Current at Output Pin	$\pm 30$ mA

Current at Power Supply Pin	40 mA
Power Dissipation	(Note 9)
ESD Tolerance (Note 9)	2 kV

## Operating Ratings (Note 1)

Temperature Range	LMC6001AI, LMC6001BI, LMC6001CI
	$-40^\circ\text{C} \leq T_J \leq +85^\circ\text{C}$
Supply Voltage	$4.5V \leq V^+ \leq 15.5V$
Thermal Resistance (Note 11)	
$\theta_{JA}$ , N Package	100°C/W
$\theta_{JA}$ , H Package	145°C/W
$\theta_{JC}$ , H Package	45°C/W
Power Dissipation	(Note 8)

## DC Electrical Characteristics

Limits in standard typeface guaranteed for  $T_J = 25^\circ\text{C}$  and limits in **boldface type** apply at the temperature extremes. Unless otherwise specified,  $V^+ = 5V, V^- = 0V, V_{CM} = 1.5V$ , and  $R_L > 1M$ .

Symbol	Parameter	Conditions	Typical (Note 4)	Limits (Note 5)			Units
				LMC6001AI	LMC6001BI	LMC6001CI	
$I_B$	Input Current	Either Input, $V_{CM} = 0V, V_S = \pm 5V$	10	25 <b>2000</b>	100 <b>4000</b>	1000 <b>4000</b>	fA
$I_{OS}$	Input Offset Current		5	<b>1000</b>	<b>2000</b>	<b>2000</b>	
$V_{OS}$	Input Offset Voltage			0.35 <b>1.0</b>	1.0 <b>1.7</b>	1.0 <b>2.0</b>	mV
		$V_S = \pm 5V, V_{CM} = 0V$		0.7 <b>1.35</b>	1.35 <b>2.0</b>	1.35	
$TCV_{OS}$	Input Offset Voltage Drift		2.5	10	10		$\mu\text{V}/^\circ\text{C}$
$R_{IN}$	Input Resistance		$>1$				Tera $\Omega$
CMRR	Common Mode Rejection Ratio	$0V \leq V_{CM} \leq 7.5V$	83	75 <b>72</b>	72 <b>68</b>	66 <b>63</b>	dB min
		$V^+ = 10V$					
+PSRR	Positive Power Supply Rejection Ratio	$5V \leq V^+ \leq 15V$	83	73 <b>70</b>	66 <b>63</b>	66 <b>63</b>	
-PSRR	Negative Power Supply Rejection Ratio	$0V \geq V^- \geq -10V$	94	80 <b>77</b>	74 <b>71</b>	74 <b>71</b>	
$A_V$	Large Signal Voltage Gain	Sourcing, $R_L = 2\text{ k}\Omega$ (Note 6)	1400	400 <b>300</b>	300 <b>200</b>	300 <b>200</b>	V/mV min
		Sinking, $R_L = 2\text{ k}\Omega$ (Note 6)	350	180 <b>100</b>	90 <b>60</b>	90 <b>60</b>	
$V_{CM}$	Input Common-Mode Voltage	$V^+ = 5V$ and $15V$ For CMRR $\geq 60$ dB	-0.4	-0.1 <b>0</b>	-0.1 <b>0</b>	-0.1 <b>0</b>	V max
			$V^+ - 1.9$	$V^+ - 2.3$ <b><math>V^+ - 2.5</math></b>	$V^+ - 2.3$ <b><math>V^+ - 2.5</math></b>	$V^+ - 2.3$ <b><math>V^+ - 2.5</math></b>	V min
$V_O$	Output Swing	$V^+ = 5V$ $R_L = 2\text{ k}\Omega$ to $2.5V$	4.87	4.80 <b>4.73</b>	4.75 <b>4.67</b>	4.75 <b>4.67</b>	V min
			0.10	0.14 <b>0.17</b>	0.20 <b>0.24</b>	0.20 <b>0.24</b>	V max
		$V^+ = 15V$ $R_L = 2\text{ k}\Omega$ to $7.5V$	14.63	14.50 <b>14.34</b>	14.37 <b>14.25</b>	14.37 <b>14.25</b>	V min
			0.26	0.35 <b>0.45</b>	0.44 <b>0.56</b>	0.44 <b>0.56</b>	V max

## DC Electrical Characteristics (Continued)

Limits in standard typeface guaranteed for  $T_J = 25^\circ\text{C}$  and limits in **boldface type** apply at the temperature extremes. Unless otherwise specified,  $V^+ = 5\text{V}$ ,  $V^- = 0\text{V}$ ,  $V_{\text{CM}} = 1.5\text{V}$ , and  $R_L > 1\text{M}$ .

Symbol	Parameter	Conditions	Typical (Note 4)	Limits (Note 5)			Units
				LMC6001AI	LMC6001BI	LMC6001CI	
$I_O$	Output Current	Sourcing, $V^+ = 5\text{V}$ , $V_O = 0\text{V}$	22	16 <b>10</b>	13 <b>8</b>	13 <b>8</b>	mA min
		Sinking, $V^+ = 5\text{V}$ , $V_O = 5\text{V}$	21	16 <b>13</b>	13 <b>10</b>	13 <b>10</b>	
		Sourcing, $V^+ = 15\text{V}$ , $V_O = 0\text{V}$	30	28 <b>22</b>	23 <b>18</b>	23 <b>18</b>	
		Sinking, $V^+ = 15\text{V}$ , $V_O = 13\text{V}$ (Note 10)	34	28 <b>22</b>	23 <b>18</b>	23 <b>18</b>	
$I_S$	Supply Current	$V^+ = 5\text{V}$ , $V_O = 1.5\text{V}$	450	750 <b>900</b>	750 <b>900</b>	750 <b>900</b>	$\mu\text{A}$ max
		$V^+ = 15\text{V}$ , $V_O = 7.5\text{V}$	550	850 <b>950</b>	850 <b>950</b>	850 <b>950</b>	

## AC Electrical Characteristics

Limits in standard typeface guaranteed for  $T_J = 25^\circ\text{C}$  and limits in **boldface type** apply at the temperature extremes. Unless otherwise specified,  $V^+ = 5\text{V}$ ,  $V^- = 0\text{V}$ ,  $V_{\text{CM}} = 1.5\text{V}$  and  $R_L > 1\text{M}$ .

Symbol	Parameter	Conditions	Typical (Note 4)	Limits (Note 5)			Units
				LM6001AI	LM6001BI	LM6001CI	
SR	Slew Rate	(Note 7)	1.5	0.8 <b>0.6</b>	0.8 <b>0.6</b>	0.8 <b>0.6</b>	V/ $\mu\text{s}$ min
GBW	Gain-Bandwidth Product		1.3				MHz
$\phi_m$	Phase Margin		50				Deg
$G_M$	Gain Margin		17				dB
$e_n$	Input-Referred Voltage Noise	$F = 1\text{ kHz}$	22				nV/ $\sqrt{\text{Hz}}$
$i_n$	Input-Referred Current Noise	$F = 1\text{ kHz}$	0.13				fA/ $\sqrt{\text{Hz}}$
THD	Total Harmonic Distortion	$F = 10\text{ kHz}$ , $A_V = -10$ , $R_L = 100\text{ k}\Omega$ , $V_O = 8\text{ V}_{\text{PP}}$	0.01				%

**Note 1:** Absolute Maximum Ratings indicate limits beyond which damage to the device may occur. Operating Ratings indicate conditions for which the device is intended to be functional but do not guarantee specific performance limits. For guaranteed specifications and test conditions, see the Electrical Characteristics. The guaranteed specifications apply only for the test conditions listed.

**Note 2:** Applies to both single supply and split supply operation. Continuous short circuit operation at elevated ambient temperature can result in exceeding the maximum allowed junction temperature of  $150^\circ\text{C}$ . Output currents in excess of  $\pm 30\text{ mA}$  over long term may adversely affect reliability.

**Note 3:** The maximum power dissipation is a function of  $T_{\text{J(max)}}$ ,  $\theta_{\text{JA}}$ , and  $T_A$ . The maximum allowable power dissipation at any ambient temperature is  $P_D = (T_{\text{J(max)}} - T_A)/\theta_{\text{JA}}$ .

**Note 4:** Typical values represent the most likely parametric norm.

**Note 5:** All limits are guaranteed by testing or statistical analysis.

**Note 6:**  $V^+ = 15\text{V}$ ,  $V_{\text{CM}} = 7.5\text{V}$  and  $R_L$  connected to  $7.5\text{V}$ . For Sourcing tests,  $7.5\text{V} \leq V_O \leq 11.5\text{V}$ . For Sinking tests,  $2.5\text{V} \leq V_O \leq 7.5\text{V}$ .

**Note 7:**  $V^+ = 15\text{V}$ . Connected as Voltage Follower with  $10\text{V}$  step input. Limit specified is the lower of the positive and negative slew rates.

**Note 8:** For operating at elevated temperatures the device must be derated based on the thermal resistance  $\theta_{\text{JA}}$  with  $P_D = (T_J - T_A)/\theta_{\text{JA}}$ .

**Note 9:** Human body model,  $1.5\text{ k}\Omega$  in series with  $100\text{ pF}$ .

**Note 10:** Do not connect the output to  $V^+$ , when  $V^+$  is greater than  $13\text{V}$  or reliability will be adversely affected.

**Note 11:** All numbers apply for packages soldered directly into a printed circuit board.

**Typical Performance Characteristics**  $V_S = \pm 7.5V$ ,  $T_A = 25^\circ C$ , unless otherwise specified

**Input Current vs Temperature**

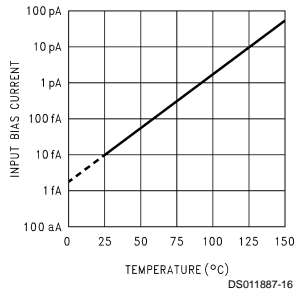

**Input Current vs  $V_{CM}$   $V_S = \pm 5V$**

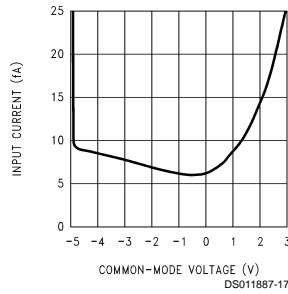

**Supply Current vs Supply Voltage**

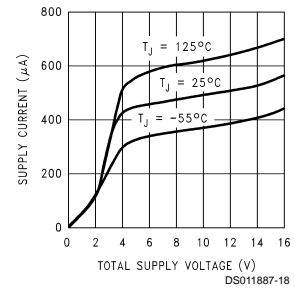

**Input Voltage vs Output Voltage**

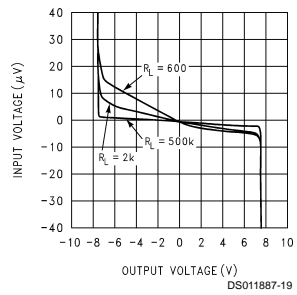

**Common Mode Rejection Ratio vs Frequency**

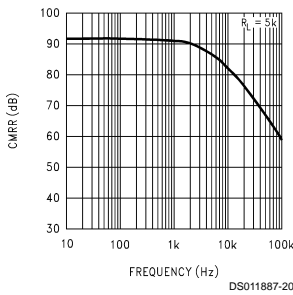

**Power Supply Rejection Ratio vs Frequency**

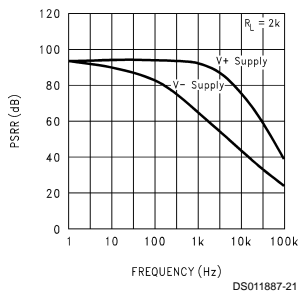

**Input Voltage Noise vs Frequency**

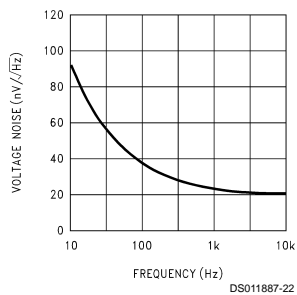

**Noise Figure vs Source Resistance**

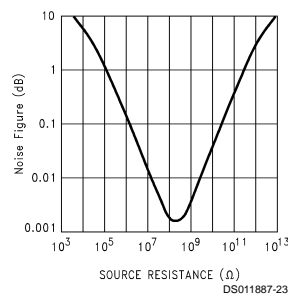

**Output Characteristics Sourcing Current**

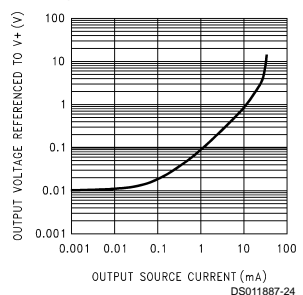

## Typical Performance Characteristics $V_S = \pm 7.5V$ , $T_A = 25^\circ C$ , unless otherwise specified (Continued)

### Output Characteristics Sinking Current

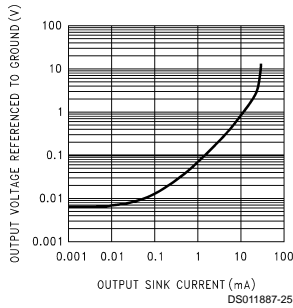

### Gain and Phase Response vs Temperature (-55°C to +125°C)

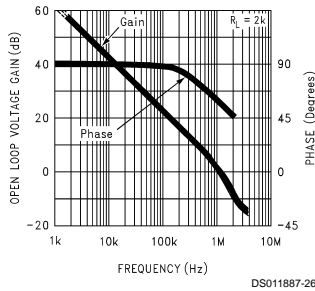

### Gain and Phase Response vs Capacitive Load with $R_L = 500\text{ k}\Omega$

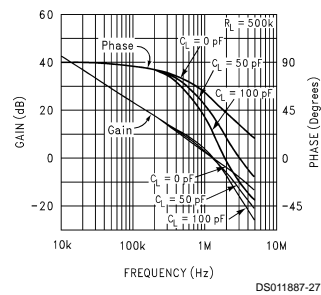

### Open Loop Frequency Response

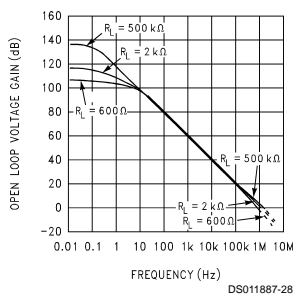

### Inverting Small Signal Pulse Response

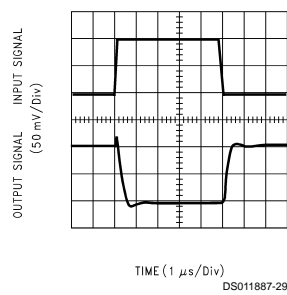

### Inverting Large Signal Pulse Response

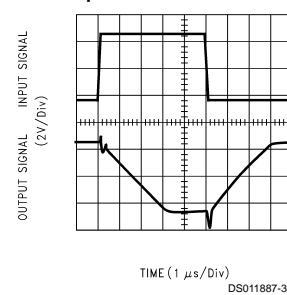

### Non-Inverting Small Signal Pulse Response

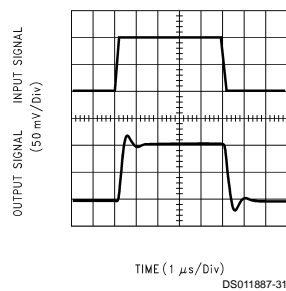

### Non-Inverting Large Signal Pulse Response

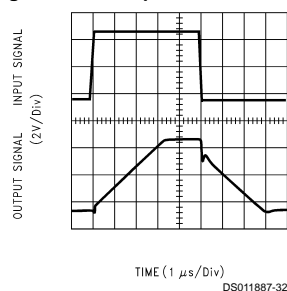

### Stability vs Capacitive Load

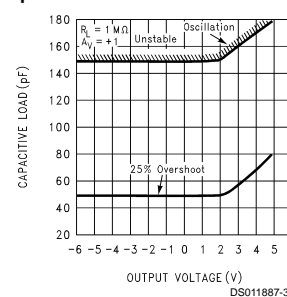

## Applications Hints

### AMPLIFIER TOPOLOGY

The LMC6001 incorporates a novel op-amp design topology that enables it to maintain rail-to-rail output swing even when driving a large load. Instead of relying on a push-pull unity gain output buffer stage, the output stage is taken directly from the internal integrator, which provides both low output impedance and large gain. Special feed-forward compensation design techniques are incorporated to maintain stability over a wider range of operating conditions than traditional

op-amps. These features make the LMC6001 both easier to design with, and provide higher speed than products typically found in this low power class.

### COMPENSATING FOR INPUT CAPACITANCE

It is quite common to use large values of feedback resistance for amplifiers with ultra-low input current, like the LMC6001.

## Applications Hints (Continued)

Although the LMC6001 is highly stable over a wide range of operating conditions, certain precautions must be met to achieve the desired pulse response when a large feedback resistor is used. Large feedback resistors with even small values of input capacitance, due to transducers, photodiodes, and circuit board parasitics, reduce phase margins.

When high input impedances are demanded, guarding of the LMC6001 is suggested. Guarding input lines will not only reduce leakage, but lowers stray input capacitance as well. (See *Printed-Circuit-Board Layout for High Impedance Work*).

The effect of input capacitance can be compensated for by adding a capacitor,  $C_f$ , around the feedback resistors (as in *Figure 1*) such that:

$$\frac{1}{2\pi R_1 C_{IN}} \geq \frac{1}{2\pi R_2 C_f}$$

or

$$R_1 C_{IN} \leq R_2 C_f$$

Since it is often difficult to know the exact value of  $C_{IN}$ ,  $C_f$  can be experimentally adjusted so that the desired pulse response is achieved. Refer to the LMC660 and LMC662 for a more detailed discussion on compensating for input capacitance.

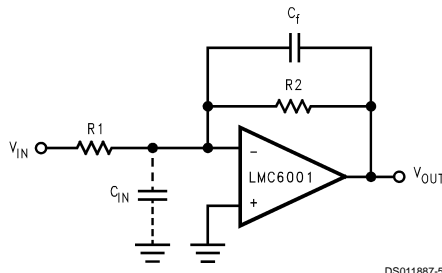

FIGURE 1. Cancelling the Effect of Input Capacitance

### CAPACITIVE LOAD TOLERANCE

All rail-to-rail output swing operational amplifiers have voltage gain in the output stage. A compensation capacitor is normally included in this integrator stage. The frequency location of the dominant pole is affected by the resistive load on the amplifier. Capacitive load driving capability can be optimized by using an appropriate resistive load in parallel with the capacitive load (see Typical Curves).

Direct capacitive loading will reduce the phase margin of many op-amps. A pole in the feedback loop is created by the combination of the op-amp's output impedance and the capacitive load. This pole induces phase lag at the unity-gain crossover frequency of the amplifier resulting in either an oscillatory or underdamped pulse response. With a few external components, op amps can easily indirectly drive capacitive loads, as shown in *Figure 2*.

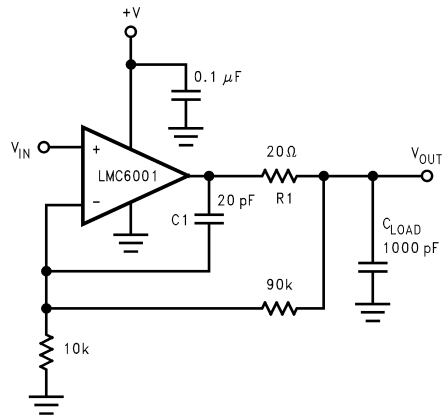

FIGURE 2. LMC6001 Noninverting Gain of 10 Amplifier, Compensated to Handle Capacitive Loads

In the circuit of *Figure 2*,  $R_1$  and  $C_1$  serve to counteract the loss of phase margin by feeding the high frequency component of the output signal back to the amplifier's inverting input, thereby preserving phase margin in the overall feedback loop.

Capacitive load driving capability is enhanced by using a pullup resistor to  $V^+$  (*Figure 3*). Typically a pullup resistor conducting 500  $\mu$ A or more will significantly improve capacitive load responses. The value of the pullup resistor must be determined based on the current sinking capability of the amplifier with respect to the desired output swing. Open loop gain of the amplifier can also be affected by the pullup resistor (see Electrical Characteristics).

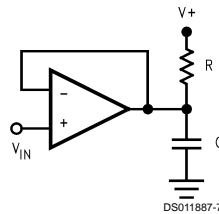

FIGURE 3. Compensating for Large Capacitive Loads with a Pullup Resistor

### PRINTED-CIRCUIT-BOARD LAYOUT FOR HIGH-IMPEDANCE WORK

It is generally recognized that any circuit which must operate with less than 1000 pA of leakage current requires special layout of the PC board. When one wishes to take advantage of the ultra-low bias current of the LMC6001, typically less than 10 fA, it is essential to have an excellent layout. Fortunately, the techniques of obtaining low leakages are quite simple. First, the user must not ignore the surface leakage of the PC board, even though it may sometimes appear acceptably low, because under conditions of high humidity or dust or contamination, the surface leakage will be appreciable.

To minimize the effect of any surface leakage, lay out a ring of foil completely surrounding the LMC6001's inputs and the terminals of capacitors, diodes, conductors, resistors, relay terminals, etc., connected to the op-amp's inputs, as in *Fig-*



## Applications Hints (Continued)

ure 4. To have a significant effect, guard rings should be placed on both the top and bottom of the PC board. This PC foil must then be connected to a voltage which is at the same voltage as the amplifier inputs, since no leakage current can flow between two points at the same potential. For example, a PC board trace-to-pad resistance of  $10^{12}\Omega$ , which is normally considered a very large resistance, could leak 5 pA if the trace were a 5V bus adjacent to the pad of the input.

This would cause a 500 times degradation from the LMC6001's actual performance. If a guard ring is used and held within 1 mV of the inputs, then the same resistance of  $10^{12}\Omega$  will only cause 10 fA of leakage current. Even this small amount of leakage will degrade the extremely low input current performance of the LMC6001. See Figure 5 for typical connections of guard rings for standard op-amp configurations.

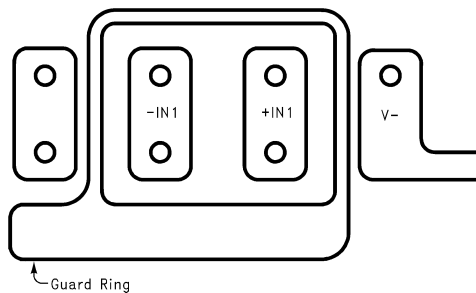
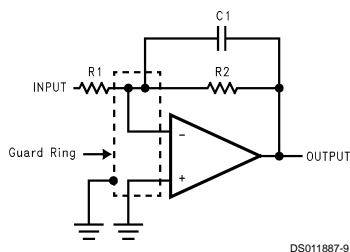
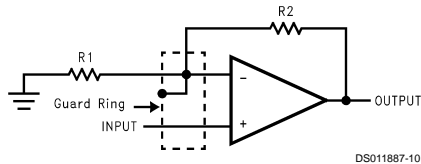

FIGURE 4. Examples of Guard Ring in PC Board Layout



Inverting Amplifier



Non-Inverting Amplifier

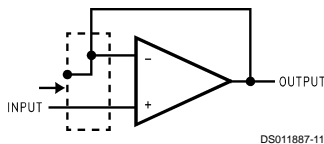

Follower

FIGURE 5. Typical Connections of Guard Rings

The designer should be aware that when it is inappropriate to lay out a PC board for the sake of just a few circuits, there is another technique which is even better than a guard ring on a PC board: Don't insert the amplifier's input pin into the board at all, but bend it up in the air and use only air as an insulator. Air is an excellent insulator. In this case you may have to forego some of the advantages of PC board construction, but the advantages are sometimes well worth the effort of using point-to-point up-in-the-air wiring. See Figure 6.

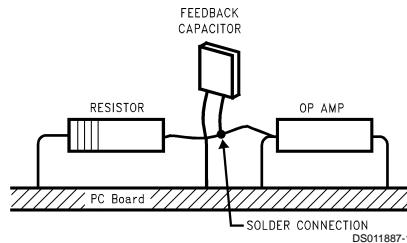

(Input pins are lifted out of PC board and soldered directly to components. All other pins connected to PC board).

FIGURE 6. Air Wiring

Another potential source of leakage that might be overlooked is the device package. When the LMC6001 is manufactured, the device is always handled with conductive finger cots. This is to assure that salts and skin oils do not cause leakage paths on the surface of the package. We recommend that these same precautions be adhered to, during all phases of inspection, test and assembly.

## Latchup

CMOS devices tend to be susceptible to latchup due to their internal parasitic SCR effects. The (I/O) input and output pins look similar to the gate of the SCR. There is a minimum current required to trigger the SCR gate lead. The LMC6001 is designed to withstand 100 mA surge current on the I/O pins. Some resistive method should be used to isolate any capacitance from supplying excess current to the I/O pins. In addition, like an SCR, there is a minimum holding current for any latchup mode. Limiting current to the supply pins will also inhibit latchup susceptibility.

## Typical Applications

The extremely high input resistance, and low power consumption, of the LMC6001 make it ideal for applications that require battery-powered instrumentation amplifiers. Examples of these types of applications are hand-held pH probes, analytic medical instruments, electrostatic field detectors and gas chromatographs.

## Two Opamp, Temperature Compensated pH Probe Amplifier

The signal from a pH probe has a typical resistance between 10 M $\Omega$  and 1000 M $\Omega$ . Because of this high value, it is very important that the amplifier input currents be as small as possible. The LMC6001 with less than 25 fA input current is an ideal choice for this application.

The theoretical output of the standard Ag/AgCl pH probe is 59.16 mV/pH at 25 °C with 0V out at a pH of 7.00. This output is proportional to absolute temperature. To compensate for this, a temperature compensating resistor, R1, is placed in

## Two Opamp, Temperature Compensated pH Probe Amplifier

(Continued)

the feedback loop. This cancels the temperature dependence of the probe. This resistor must be mounted where it will be at the same temperature as the liquid being measured.

The LMC6001 amplifies the probe output providing a scaled voltage of  $\pm 100$  mV/pH from a pH of 7. The second opamp, a micropower LMC6041 provides phase inversion and offset so that the output is directly proportional to pH, over the full range of the probe. The pH reading can now be directly displayed on a low cost, low power digital panel meter. Total current consumption will be about 1 mA for the whole system.

The micropower dual operational amplifier, LMC6042, would optimize power consumption but not offer these advantages:

1. The LMC6001A guarantees a 25 fA limit on input current at 25°C.
2. The input ESD protection diodes in the LMC6042 are only rated at 500V while the LMC6001 has much more robust protection that is rated at 2000V.

The setup and calibration is simple with no interactions to cause problems.

1. Disconnect the pH probe and with R3 set to about mid-range and the noninverting input of the LMC6001 grounded, adjust R8 until the output is 700 mV.
2. Apply  $-414.1$  mV to the noninverting input of the LMC6001. Adjust R3 for an output of 1400 mV. This completes the calibration. As real pH probes may not perform exactly to theory, minor gain and offset adjustments should be made by trimming while measuring a precision buffer solution.

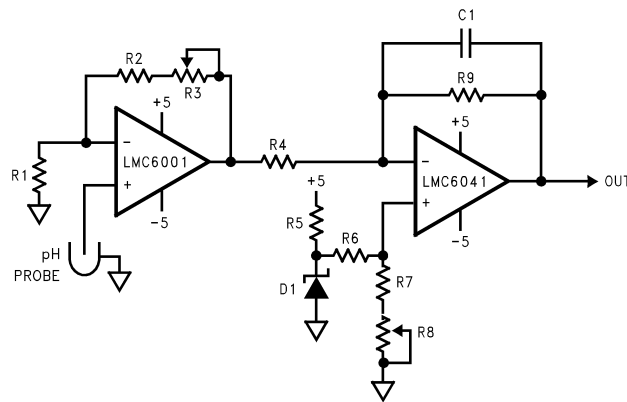

DS011887-15

R1 100k + 3500 ppm/°C (Note 12)  
 R2 68.1k  
 R3, 8 5k  
 R4, 9 100k  
 R5 36.5k  
 R6 619k  
 R7 97.6k  
 D1 LM4040D1Z-2.5  
 C1 2.2  $\mu$ F

Note 12: (Micro-ohm style 144 or similar)

FIGURE 7. pH Probe Amplifier

## Ultra-Low Input Current Instrumentation Amplifier

Figure 8 shows an instrumentation amplifier that features high differential and common mode input resistance ( $>10^{14}\Omega$ ), 0.01% gain accuracy at  $A_v = 1000$ , excellent CMRR with 1 M $\Omega$  imbalance in source resistance. Input current is less than 20 fA and offset drift is less than 2.5  $\mu$ V/°C.

$R_2$  provides a simple means of adjusting gain over a wide range without degrading CMRR.  $R_7$  is an initial trim used to maximize CMRR without using super precision matched resistors. For good CMRR over temperature, low drift resistors should be used.

## Ultra-Low Input Current Instrumentation Amplifier (Continued)

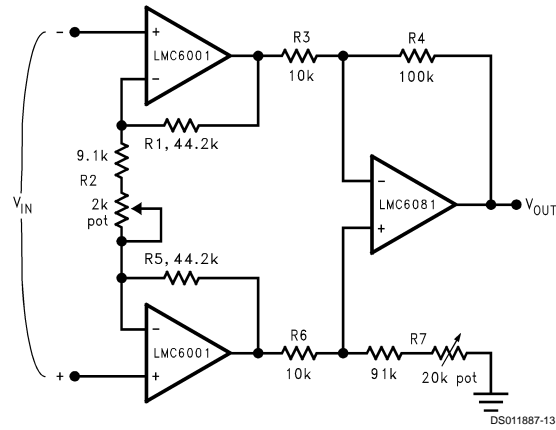

If  $R_1 = R_5$ ,  $R_3 = R_6$ , and  $R_4 = R_7$ ; then

$$\frac{V_{OUT}}{V_{IN}} = \frac{R_2 + 2R_1}{R_2} \times \frac{R_4}{R_3}$$

$\therefore A_v = 100$  for circuit shown ( $R_2 = 9.85k$ ).

**FIGURE 8. Instrumentation Amplifier**

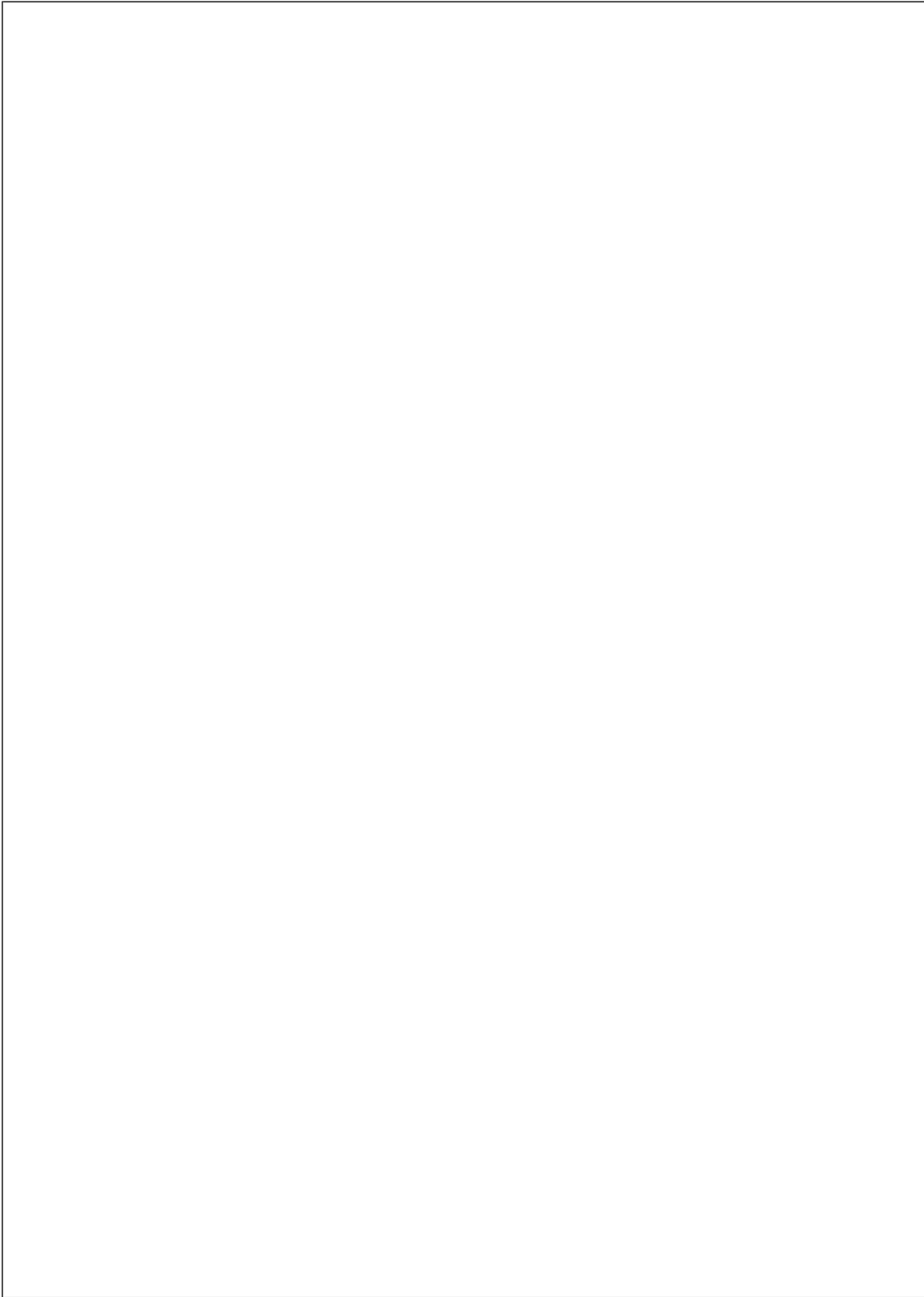



**Physical Dimensions** inches (millimeters) unless otherwise noted (Continued)

**LIFE SUPPORT POLICY**

NATIONAL'S PRODUCTS ARE NOT AUTHORIZED FOR USE AS CRITICAL COMPONENTS IN LIFE SUPPORT DEVICES OR SYSTEMS WITHOUT THE EXPRESS WRITTEN APPROVAL OF THE PRESIDENT OF NATIONAL SEMICONDUCTOR CORPORATION. As used herein:

1. Life support devices or systems are devices or systems which, (a) are intended for surgical implant into the body, or (b) support or sustain life, and whose failure to perform when properly used in accordance with instructions for use provided in the labeling, can be reasonably expected to result in a significant injury to the user.
2. A critical component is any component of a life support device or system whose failure to perform can be reasonably expected to cause the failure of the life support device or system, or to affect its safety or effectiveness.



**National Semiconductor Corporation**  
Americas  
Tel: 1-800-272-9959  
Fax: 1-800-737-7018  
Email: support@nsc.com

**National Semiconductor Europe**  
Fax: +49 (0) 1 80-530 85 86  
Email: europe.support@nsc.com  
Deutsch Tel: +49 (0) 1 80-530 85 85  
English Tel: +49 (0) 1 80-532 78 32  
Français Tel: +49 (0) 1 80-532 93 58  
Italiano Tel: +49 (0) 1 80-534 16 80

**National Semiconductor Asia Pacific Customer Response Group**  
Tel: 65-2544466  
Fax: 65-2504466  
Email: sea.support@nsc.com

**National Semiconductor Japan Ltd.**  
Tel: 81-3-5639-7560  
Fax: 81-3-5639-7507

www.national.com