

Notice for TAIYO YUDEN products

Please read this notice before using the TAIYO YUDEN products.

REMINDERS

- Product information in this catalog is as of October 2015. All of the contents specified herein are subject to change without notice due to technical improvements, etc. Therefore, please check for the latest information carefully before practical application or usage of the Products.

Please note that TAIYO YUDEN CO., LTD. shall not be responsible for any defects in products or equipment incorporating such products, which are caused under the conditions other than those specified in this catalog or individual specification.

- Please contact TAIYO YUDEN CO., LTD. for further details of product specifications as the individual specification is available.

- Please conduct validation and verification of products in actual condition of mounting and operating environment before commercial shipment of the equipment.

- All electronic components or functional modules listed in this catalog are developed, designed and intended for use in general electronics equipment.(for AV, office automation, household, office supply, information service, telecommunications, (such as mobile phone or PC) etc.). Before incorporating the components or devices into any equipment in the field such as transportation,(automotive control, train control, ship control), transportation signal, disaster prevention, medical, public information network (telephone exchange, base station) etc. which may have direct influence to harm or injure a human body, please contact TAIYO YUDEN CO., LTD. for more detail in advance.

Do not incorporate the products into any equipment in fields such as aerospace, aviation, nuclear control, submarine system, military, etc. where higher safety and reliability are especially required.

In addition, even electronic components or functional modules that are used for the general electronic equipment, if the equipment or the electric circuit require high safety or reliability function or performances, a sufficient reliability evaluation check for safety shall be performed before commercial shipment and moreover, due consideration to install a protective circuit is strongly recommended at customer's design stage.

- The contents of this catalog are applicable to the products which are purchased from our sales offices or distributors (so called "TAIYO YUDEN' s official sales channel").

It is only applicable to the products purchased from any of TAIYO YUDEN' s official sales channel.

- Please note that TAIYO YUDEN CO., LTD. shall have no responsibility for any controversies or disputes that may occur in connection with a third party's intellectual property rights and other related rights arising from your usage of products in this catalog. TAIYO YUDEN CO., LTD. grants no license for such rights.

- Caution for export

Certain items in this catalog may require specific procedures for export according to "Foreign Exchange and Foreign Trade Control Law" of Japan, "U.S. Export Administration Regulations", and other applicable regulations. Should you have any question or inquiry on this matter, please contact our sales staff.

MULTILAYER CERAMIC CAPACITORS



WAVE REFLOW

PARTS NUMBER

J	M	K	3	1	6	△	B	J	1	0	6	M	L	-	T	△
①	②	③	④	⑤	⑥	⑦	⑧	⑨	⑩	⑪	⑫					

△=Blank space

① Rated voltage

Code	Rated voltage [VDC]
P	2.5
A	4
J	6.3
L	10
E	16
T	25
G	35
U	50
H	100
Q	250
S	630

③ End termination

Code	End termination
K	Plated
S	Cu Internal Electrodes

② Series name

Code	Series name
M	Multilayer ceramic capacitor
V	Multilayer ceramic capacitor for high frequency
W	LW reverse type multilayer capacitor

④ Dimension (L × W)

Type	Dimensions (L × W) [mm]	EIA (inch)
021	0.25 × 0.125	008004
042	0.4 × 0.2	01005
063	0.6 × 0.3	0201
105	1.0 × 0.5	0402
	0.52 × 1.0 ※	0204
107	1.6 × 0.8	0603
	0.8 × 1.6 ※	0306
212	2.0 × 1.25	0805
	1.25 × 2.0 ※	0508
316	3.2 × 1.6	1206
325	3.2 × 2.5	1210
432	4.5 × 3.2	1812

Note : ※LW reverse type (□WK) only

⑤ Dimension tolerance

Code	Type	L [mm]	W [mm]	T [mm]
△	ALL	Standard	Standard	Standard
A	063	0.6±0.05	0.3±0.05	0.3±0.05
	105	1.0±0.10	0.5±0.10	0.5±0.10
	107	1.6+0.15/-0.05	0.8+0.15/-0.05	0.8+0.15/-0.05
	212	2.0+0.15/-0.05	1.25+0.15/-0.05	0.45±0.05
				0.85±0.10
				1.25+0.15/-0.05
316	3.2±0.20	1.6±0.20	0.85±0.10	
325	3.2±0.30	2.5±0.30	1.6±0.20	
B	063	0.6±0.09	0.3±0.09	2.5±0.30
	105	1.0+0.15/-0.05	0.5+0.15/-0.05	0.3±0.09
	107	1.6+0.20/-0	0.8+0.20/-0	0.45±0.05
				0.8+0.20/-0
	212	2.0+0.20/-0	1.25+0.20/-0	0.45±0.05
0.85±0.10				
316	3.2±0.30	1.6±0.30	1.25+0.20/-0	
C	105	1.0+0.20/-0	0.5+0.20/-0	1.6±0.30
				0.5+0.20/-0

Note: P.6 Standard external dimensions

△= Blank space

⑥ Temperature characteristics code

■ High dielectric type (Excluding Super low distortion multilayer ceramic capacitor (CFCAP™))

Code	Applicable standard	Temperature range [°C]	Ref. Temp. [°C]	Capacitance change	Capacitance tolerance	Tolerance code
BJ	JIS	B	-25~+85	20	±10%	K
						M
	EIA	X5R	-55~+85	25	±15%	K
B7	EIA	X7R	-55~+125	25	±15%	M
						K
C6	EIA	X6S	-55~+105	25	±22%	K
						M
C7	EIA	X7S	-55~+125	25	±22%	K
						M
LD(※)	EIA	X5R	-55~+85	25	±15%	K
						M
△F	JIS	F	-25~+85	20	+30/-80%	Z
						EIA

Note : ※LD Low distortion high value multilayer ceramic capacitor

△= Blank space

▶ This catalog contains the typical specification only due to the limitation of space. When you consider the purchase of our products, please check our specification. For details of each product (characteristics graph, reliability information, precautions for use, and so on), see our Web site (<http://www.ty-top.com/>).

■ Temperature compensating type

Code	Applicable standard		Temperature range [°C]	Ref. Temp. [°C]	Capacitance change	Capacitance tolerance	Tolerance code
CG	EIA	C0G	-55 ~ +125	25	0 ± 30ppm/°C	±0.05pF	A
						±0.1pF	B
						±0.25pF	C
						±0.5pF	D
						±5%	J
CH	JIS	CH	-55 ~ +125	20	0 ± 60ppm/°C	±0.05pF	A
						±0.1pF	B
	EIA	C0H		25		±0.25pF	C
						±0.5pF	D
						±5%	J
CJ	JIS	CJ	-55 ~ +125	20	0 ± 120ppm/°C	±0.1pF	B
	EIA	C0J		25		±0.25pF	C
CK	JIS	CK	-55 ~ +125	20	0 ± 250ppm/°C	±0.05pF	A
				25		±0.1pF	B
	EIA	C0K		±0.25pF		C	
UJ	JIS	UJ	-55 ~ +125	20	-750 ± 120ppm/°C	±0.25pF	C
				25		±0.5pF	D
	EIA	U2J		±5%		J	
UK	JIS	UK	-55 ~ +125	20	-750 ± 250ppm/°C	±0.25pF	C
	EIA	U2K	-55 ~ +125	25			
SL	JIS	SL	-55 ~ +125	20	+350 ~ -1000ppm/°C	±5%	J

⑥ Series code

(Super low distortion multilayer ceramic capacitor (CFCAP™) only)

Code	Series code
SD	Standard

• Medium-High Voltage Multilayer Ceramic Capacitors

Code	Series code
SD	Standard

⑦ Nominal capacitance

Code (example)	Nominal capacitance
0R5	0.5pF
010	1pF
100	10pF
101	100pF
102	1,000pF
103	10,000pF
104	0.1 μF
105	1.0 μF
106	10 μF
107	100 μF

Note : R=Decimal point

⑧ Capacitance tolerance

Code	Capacitance tolerance
A	±0.05pF
B	±0.1pF
C	±0.25pF
D	±0.5pF
F	±1pF
G	±2%
J	±5%
K	±10%
M	±20%
Z	+80/-20%

⑨ Thickness

Code	Thickness [mm]
K	0.125
H	0.13
E	0.18
C	0.2
D	
P	
T	0.3
K	
V	0.45 (107type or more)
W	
A	0.5
D	
D	0.85 (212type or more)
F	
G	1.15
L	1.25
N	1.6
Y	1.9
Y	2.0 max
M	2.5

⑩ Special code

Code	Special code
-	Standard

⑪ Packaging

Code	Packaging
F	φ178mm Taping (2mm pitch)
T	φ178mm Taping (4mm pitch)
P	φ178mm Taping (4mm pitch, 1000 pcs/reel) 325 type (Thickness code M)
R	φ178mm Taping (2mm pitch) 105type only (Thickness code E,H)
W	φ178mm Taping (1mm pitch) 021/042type only

⑫ Internal code

Code	Internal code
Δ	Standard

▶ This catalog contains the typical specification only due to the limitation of space. When you consider the purchase of our products, please check our specification. For details of each product (characteristics graph, reliability information, precautions for use, and so on), see our Web site (<http://www.ty-top.com/>).

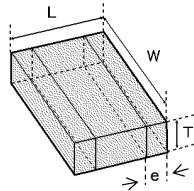
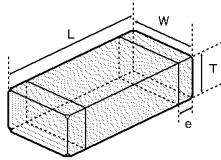

※ LW reverse type

Type(EIA)	Dimension [mm]				
	L	W	T	*1	e
□MK021(008004)	0.25±0.013	0.125±0.013	0.125±0.013	K	0.0675±0.0275
□MK042(01005)	0.4±0.02	0.2±0.02	0.2±0.02	C	0.1±0.03
				D	
□VS042(01005)	0.4±0.02	0.2±0.02	0.2±0.02	C	0.1±0.03
□MK063(0201)	0.6±0.03	0.3±0.03	0.3±0.03	P	0.15±0.05
				T	
□MK105(0402)	1.0±0.05	0.5±0.05	0.13±0.02	H	0.25±0.10
			0.18±0.02	E	
			0.2±0.02	C	
			0.3±0.03	P	
			0.5±0.05	V	
□VK105(0402)	1.0±0.05	0.5±0.05	0.5±0.05	W	0.25±0.10
□WK105(0204)※	0.52±0.05	1.0±0.05	0.3±0.05	P	0.18±0.08
□MK107(0603)	1.6±0.10	0.8±0.10	0.45±0.05	K	0.35±0.25
			0.8±0.10	A	
□WK107(0306)※	0.8±0.10	1.6±0.10	0.5±0.05	V	0.25±0.15
□MK212(0805)	2.0±0.10	1.25±0.10	0.45±0.05	K	0.5±0.25
			0.85±0.10	D	
			1.25±0.10	G	
□WK212(0508)※	1.25±0.15	2.0±0.15	0.85±0.1	D	0.3±0.2
□MK316(1206)	3.2±0.15	1.6±0.15	0.85±0.10	D	0.5+0.35/-0.25
			1.15±0.10	F	
			1.25±0.10	G	
			1.6±0.20	L	
□MK325(1210)	3.2±0.30	2.5±0.20	0.85±0.10	D	0.6±0.3
			1.15±0.10	F	
			1.9±0.20	N	
			1.9+0.1/-0.2	Y	
□MK432(1812)	4.5±0.40	3.2±0.30	2.5±0.20	M	0.9±0.6

Note : ※. LW reverse type, *1.Thickness code

STANDARD QUANTITY

Type	EIA (inch)	Dimension		Standard quantity [pcs]	
		[mm]	Code	Paper tape	Embossed tape
021	008004	0.125	K	—	50000
042	01005	0.2	C	—	40000
			D		
063	0201	0.3	P	15000	—
			T		
105	0402	0.13	H	—	20000
		0.18	E	—	15000
		0.2	C	20000	—
		0.3	P	15000	—
		0.5	V	10000	—
	0.5	W			
0204 ※	0.30	P	—	—	
107	0603	0.45	K	4000	—
		0.8	A		
	0306 ※	0.50	V	—	4000
212	0805	0.45	K	4000	—
		0.85	D		
		1.25	G		
	0508 ※	0.85	D	4000	—
316	1206	0.85	D	4000	—
		1.15	F	—	3000
		1.25	G	—	3000
		1.6	L	—	2000
325	1210	0.85	D	—	2000
		1.15	F		
		1.9	N		
		2.0 max	Y		
		2.5	M		
432	1812	2.5	M	—	500

Note : ※.LW Reverse type(□WK)

▶ This catalog contains the typical specification only due to the limitation of space. When you consider the purchase of our products, please check our specification. For details of each product (characteristics graph, reliability information, precautions for use, and so on), see our Web site (<http://www.ty-top.com/>).

■ PARTS NUMBER

- All the Multilayer Ceramic Capacitors of Catalog Lineup are Compliance RoHS.
- Capacitance tolerance code is applied to □ of part number.

Note)

*1 We may provide X7R/X7S for some items according to the individual specification.

*2 The exchange of individual specification is necessary depending on the application and circuit condition. Please contact TAIYO YUDEN sales channels.

*3 The size standard should look at ④Dimension, ⑤Dimension tolerance, and ⑨Thickness, and P.6 Standard external dimensions.

Multilayer Ceramic Capacitors (High dielectric type)

● 021TYPE

【Temperature Characteristic BJ : B/X5R】 0.125mm thickness(K)

Part number 1	Part number 2	Rated voltage [V]	Temperature characteristics		Capacitance [F]	Capacitance tolerance [%]	tan δ [%]	HTLT		Soldering R:Reflow W:Wave
								Rated voltage x %	Thickness*3 [mm]	
EMK021 BJ221□K-W		16		X5R	220 p	±10, ±20	10	150	0.125±0.013	R
EMK021 BJ471□K-W				X5R	470 p	±10, ±20	10	150	0.125±0.013	R
EMK021 BJ102□K-W				X5R	1000 p	±10, ±20	10	150	0.125±0.013	R
JMK021 BJ222□K-W		6.3		X5R	2200 p	±10, ±20	10	150	0.125±0.013	R
JMK021 BJ472□K-W				X5R	4700 p	±10, ±20	10	150	0.125±0.013	R
JMK021 BJ103□K-W				X5R	0.01 μ	±10, ±20	10	150	0.125±0.013	R
AMK021 BJ223MK-W		4		X5R	0.022 μ	±20	10	150	0.125±0.013	R

● 042TYPE

【Temperature Characteristic BJ : B/X5R】 0.2mm thickness(C)

Part number 1	Part number 2	Rated voltage [V]	Temperature characteristics		Capacitance [F]	Capacitance tolerance [%]	tan δ [%]	HTLT		Soldering R:Reflow W:Wave	
								Rated voltage x %	Thickness*3 [mm]		
LMK042 BJ101□C-W		10	B	X5R*1	100 p	±10, ±20	5	200	0.2±0.02	R	
LMK042 BJ151□C-W			B	X5R*1	150 p	±10, ±20	5	200	0.2±0.02	R	
LMK042 BJ221□C-W			B	X5R*1	220 p	±10, ±20	5	200	0.2±0.02	R	
LMK042 BJ331□C-W			B	X5R*1	330 p	±10, ±20	5	200	0.2±0.02	R	
LMK042 BJ471□C-W			B	X5R*1	470 p	±10, ±20	5	200	0.2±0.02	R	
LMK042 BJ681□C-W			B	X5R*1	680 p	±10, ±20	5	200	0.2±0.02	R	
LMK042 BJ102□C-W			B	X5R*1	1000 p	±10, ±20	5	200	0.2±0.02	R	
LMK042 BJ152□C-W				X5R	1500 p	±10, ±20	10	150	0.2±0.02	R	
LMK042 BJ222□C-W				X5R	2200 p	±10, ±20	10	150	0.2±0.02	R	
LMK042 BJ332□C-W				X5R	3300 p	±10, ±20	10	150	0.2±0.02	R	
LMK042 BJ472□C-W				X5R	4700 p	±10, ±20	10	150	0.2±0.02	R	
LMK042 BJ682□C-W				X5R	6800 p	±10, ±20	10	150	0.2±0.02	R	
LMK042 BJ103□C-W		6.3		X5R	0.01 μ	±10, ±20	10	150	0.2±0.02	R	
JMK042 BJ152□C-W			B	X5R*1	1500 p	±10, ±20	10	150	0.2±0.02	R	
JMK042 BJ222□C-W			B	X5R*1	2200 p	±10, ±20	10	150	0.2±0.02	R	
JMK042 BJ332□C-W			B	X5R*1	3300 p	±10, ±20	10	150	0.2±0.02	R	
JMK042 BJ472□C-W			B	X5R*1	4700 p	±10, ±20	10	150	0.2±0.02	R	
JMK042 BJ682□C-W			B	X5R*1	6800 p	±10, ±20	10	150	0.2±0.02	R	
JMK042 BJ103□C-W			B	X5R*1	0.01 μ	±10, ±20	10	150	0.2±0.02	R	
JMK042 BJ223□C-W				X5R	0.022 μ	±10, ±20	10	150	0.2±0.02	R	
JMK042 BJ473□C-W				X5R	0.047 μ	±10, ±20	10	150	0.2±0.02	R	
JMK042 BJ104□C-W				X5R	0.1 μ	±10, ±20	10	150	0.2±0.02	R	
AMK042 BJ473□C-W			4		X5R	0.047 μ	±10, ±20	10	150	0.2±0.02	R
AMK042 BJ104□C-W					X5R	0.1 μ	±10, ±20	10	150	0.2±0.02	R

【Temperature Characteristic B7 : X7R】 0.2mm thickness(C)

Part number 1	Part number 2	Rated voltage [V]	Temperature characteristics		Capacitance [F]	Capacitance tolerance [%]	tan δ [%]	HTLT		Soldering R:Reflow W:Wave	
								Rated voltage x %	Thickness*3 [mm]		
EMK042 B7101□C-W		16		X7R	100 p	±10, ±20	5	200	0.2±0.02	R	
EMK042 B7151□C-W				X7R	150 p	±10, ±20	5	200	0.2±0.02	R	
EMK042 B7221□C-W				X7R	220 p	±10, ±20	5	200	0.2±0.02	R	
EMK042 B7331□C-W				X7R	330 p	±10, ±20	5	200	0.2±0.02	R	
EMK042 B7471□C-W				X7R	470 p	±10, ±20	5	200	0.2±0.02	R	
EMK042 B7681□C-W				X7R	680 p	±10, ±20	5	200	0.2±0.02	R	
EMK042 B7102□C-W				X7R	1000 p	±10, ±20	5	200	0.2±0.02	R	
LMK042 B7101□C-W			10		X7R	100 p	±10, ±20	5	200	0.2±0.02	R
LMK042 B7151□C-W					X7R	150 p	±10, ±20	5	200	0.2±0.02	R
LMK042 B7221□C-W					X7R	220 p	±10, ±20	5	200	0.2±0.02	R
LMK042 B7331□C-W					X7R	330 p	±10, ±20	5	200	0.2±0.02	R
LMK042 B7471□C-W					X7R	470 p	±10, ±20	5	200	0.2±0.02	R
LMK042 B7681□C-W				X7R	680 p	±10, ±20	5	200	0.2±0.02	R	
LMK042 B7102□C-W			X7R	1000 p	±10, ±20	5	200	0.2±0.02	R		

● 063TYPE

【Temperature Characteristic BJ : B/X5R】 0.3mm thickness(P)

Part number 1	Part number 2	Rated voltage [V]	Temperature characteristics		Capacitance [F]	Capacitance tolerance [%]	tan δ [%]	HTLT		Soldering R:Reflow W:Wave
								Rated voltage x %	Thickness*3 [mm]	
UMK063 BJ101□P-F		50	B	X5R*1	100 p	±10, ±20	3.5	200	0.3±0.03	R
UMK063 BJ151□P-F			B	X5R*1	150 p	±10, ±20	3.5	200	0.3±0.03	R
UMK063 BJ221□P-F			B	X5R*1	220 p	±10, ±20	3.5	200	0.3±0.03	R
UMK063 BJ331□P-F			B	X5R*1	330 p	±10, ±20	3.5	200	0.3±0.03	R
UMK063 BJ471□P-F			B	X5R*1	470 p	±10, ±20	3.5	200	0.3±0.03	R
UMK063 BJ681□P-F			B	X5R*1	680 p	±10, ±20	3.5	200	0.3±0.03	R
UMK063 BJ102□P-F			B	X5R*1	1000 p	±10, ±20	3.5	200	0.3±0.03	R
UMK063 BJ152□P-F			B	X5R	1500 p	±10, ±20	5	200	0.3±0.03	R
UMK063 BJ222□P-F			B	X5R	2200 p	±10, ±20	5	200	0.3±0.03	R
UMK063 BJ332□P-F			B	X5R	3300 p	±10, ±20	5	200	0.3±0.03	R
UMK063 BJ472□P-F			B	X5R	4700 p	±10, ±20	5	200	0.3±0.03	R
UMK063 BJ682□P-F			B	X5R	6800 p	±10, ±20	5	200	0.3±0.03	R
UMK063 BJ103□P-F		35	B	X5R	0.01 μ	±10, ±20	5	200	0.3±0.03	R
GMK063 BJ104□P-F				X5R	0.1 μ	±10, ±20	10	150	0.3±0.03	R

▶ This catalog contains the typical specification only due to the limitation of space. When you consider the purchase of our products, please check our specification. For details of each product (characteristics graph, reliability information, precautions for use, and so on), see our Web site (<http://www.ty-top.com/>).

■ PARTS NUMBER

Part number 1	Part number 2	Rated voltage [V]	Temperature characteristics	Capacitance [F]	Capacitance tolerance [%]	tan δ [%]	HTLT	Thickness*3 [mm]	Soldering R:Reflow W:Wave		
							Rated voltage x %				
TMK063 BJ152□P-F		25	B X5R	1500 p	±10, ±20	5	200	0.3±0.03	R		
TMK063 BJ222□P-F			B X5R	2200 p	±10, ±20	5	200	0.3±0.03	R		
TMK063 BJ332□P-F			B X5R	3300 p	±10, ±20	5	200	0.3±0.03	R		
TMK063 BJ472□P-F			B X5R	4700 p	±10, ±20	5	200	0.3±0.03	R		
TMK063 BJ682□P-F			B X5R	6800 p	±10, ±20	5	200	0.3±0.03	R		
TMK063 BJ103□P-F			B X5R	0.01 μ	±10, ±20	5	200	0.3±0.03	R		
TMK063 BJ223□P-F			B X5R	0.022 μ	±10, ±20	7.5	150	0.3±0.03	R		
TMK063ABJ104□P-F				X5R	0.1 μ	±10, ±20	10	150	0.3±0.05	R	
EMK063 BJ152□P-F			16	B X5R*1	1500 p	±10, ±20	5	200	0.3±0.03	R	
EMK063 BJ222□P-F				B X5R*1	2200 p	±10, ±20	5	200	0.3±0.03	R	
EMK063 BJ332□P-F		B X5R*1		3300 p	±10, ±20	5	200	0.3±0.03	R		
EMK063 BJ472□P-F		B X5R*1		4700 p	±10, ±20	5	200	0.3±0.03	R		
EMK063 BJ682□P-F		B X5R*1		6800 p	±10, ±20	5	200	0.3±0.03	R		
EMK063 BJ103□P-F		B X5R*1		0.01 μ	±10, ±20	5	200	0.3±0.03	R		
EMK063 BJ223□P-F		B X5R		0.022 μ	±10, ±20	7.5	150	0.3±0.03	R		
EMK063 BJ333□P-F				X5R	0.033 μ	±10, ±20	7.5	150	0.3±0.03	R	
EMK063 BJ473□P-F				X5R	0.047 μ	±10, ±20	7.5	150	0.3±0.03	R	
EMK063 BJ683□P-F				X5R	0.068 μ	±10, ±20	10	150	0.3±0.03	R	
EMK063 BJ104□P-F				X5R	0.1 μ	±10, ±20	10	150	0.3±0.03	R	
EMK063 BJ224□P-F				X5R	0.22 μ	±10, ±20	10	150	0.3±0.03	R	
LМК063 BJ223□P-F		10		B X5R	0.022 μ	±10, ±20	7.5	150	0.3±0.03	R	
LМК063 BJ333□P-F					X5R	0.033 μ	±10, ±20	7.5	150	0.3±0.03	R
LМК063 BJ473□P-F					X5R	0.047 μ	±10, ±20	7.5	150	0.3±0.03	R
LМК063 BJ683□P-F					X5R	0.068 μ	±10, ±20	10	150	0.3±0.03	R
LМК063 BJ104□P-F				X5R	0.1 μ	±10, ±20	10	150	0.3±0.03	R	
LМК063 BJ224□P-F				X5R	0.22 μ	±10, ±20	10	150	0.3±0.03	R	
LМК063BBJ105MPLF				X5R	1 μ	±20	10	150	0.3±0.09	R	
JMK063 BJ223□P-F			6.3	B X5R	0.022 μ	±10, ±20	7.5	150	0.3±0.03	R	
JMK063 BJ333□P-F					X5R	0.033 μ	±10, ±20	7.5	150	0.3±0.03	R
JMK063 BJ473□P-F					X5R	0.047 μ	±10, ±20	7.5	150	0.3±0.03	R
JMK063 BJ683□P-F				X5R	0.068 μ	±10, ±20	10	150	0.3±0.03	R	
JMK063 BJ104□P-F				X5R	0.1 μ	±10, ±20	10	150	0.3±0.03	R	
JMK063 BJ224□P-F				X5R	0.22 μ	±10, ±20	10	150	0.3±0.03	R	
JMK063 BJ334MP-F				X5R	0.33 μ	±20	10	150	0.3±0.03	R	
JMK063 BJ474□P-F				X5R	0.47 μ	±10, ±20	10	150	0.3±0.03	R	
JMK063ABJ105MP-F				X5R	1 μ	±20	10	150	0.3±0.05	R	
AMK063 BJ224□P-F		4		X5R	0.22 μ	±10, ±20	10	150	0.3±0.03	R	
AMK063 BJ334MP-F				X5R	0.33 μ	±20	10	150	0.3±0.03	R	
AMK063 BJ474□P-F				X5R	0.47 μ	±10, ±20	10	150	0.3±0.03	R	
AMK063ABJ105MP-F				X5R	1 μ	±20	10	150	0.3±0.05	R	

[Temperature Characteristic C6 : X6S] 0.3mm thickness (P)

Part number 1	Part number 2	Rated voltage [V]	Temperature characteristics	Capacitance [F]	Capacitance tolerance [%]	tan δ [%]	HTLT	Thickness*3 [mm]	Soldering R:Reflow W:Wave	
							Rated voltage x %			
TMK063 C6104□P-F		25	X6S	0.1 μ	±10, ±20	10	150	0.3±0.03	R	
EMK063AC6104□P-F		16	X6S	0.1 μ	±10, ±20	10	150	0.3±0.05	R	
LМК063 C6333□P-F				X6S	0.033 μ	±10, ±20	7.5	150	0.3±0.03	R
LМК063 C6473□P-F		10	X6S	0.047 μ	±10, ±20	7.5	150	0.3±0.03	R	
LМК063 C6683□P-F			X6S	0.068 μ	±10, ±20	10	150	0.3±0.03	R	
LМК063 C6104□P-F			X6S	0.1 μ	±10, ±20	10	150	0.3±0.03	R	
LМК063 C6224□P-F			X6S	0.22 μ	±10, ±20	10	150	0.3±0.03	R	
JMK063 C6333□P-F			6.3	X6S	0.033 μ	±10, ±20	7.5	150	0.3±0.03	R
JMK063 C6473□P-F				X6S	0.047 μ	±10, ±20	7.5	150	0.3±0.03	R
JMK063 C6683□P-F		X6S		0.068 μ	±10, ±20	10	150	0.3±0.03	R	
JMK063 C6104□P-F		X6S		0.1 μ	±10, ±20	10	150	0.3±0.03	R	
JMK063 C6224□P-F		X6S		0.22 μ	±10, ±20	10	150	0.3±0.03	R	
JMK063BC6105MP-F				X6S	1 μ	±20	10	150	0.3±0.09	R
AMK063 C6474MP-F		4	X6S	0.47 μ	±20	10	150	0.3±0.03	R	
AMK063AC6105MP-F			X6S	1 μ	±20	10	150	0.3±0.05	R	

[Temperature Characteristic B7 : X7R] 0.3mm thickness (P)

Part number 1	Part number 2	Rated voltage [V]	Temperature characteristics	Capacitance [F]	Capacitance tolerance [%]	tan δ [%]	HTLT	Thickness*3 [mm]	Soldering R:Reflow W:Wave	
							Rated voltage x %			
UMK063 B7101□P-F		50	X7R	100 p	±10, ±20	3.5	200	0.3±0.03	R	
UMK063 B7151□P-F			X7R	150 p	±10, ±20	3.5	200	0.3±0.03	R	
UMK063 B7221□P-F			X7R	220 p	±10, ±20	3.5	200	0.3±0.03	R	
UMK063 B7331□P-F			X7R	330 p	±10, ±20	3.5	200	0.3±0.03	R	
UMK063 B7471□P-F			X7R	470 p	±10, ±20	3.5	200	0.3±0.03	R	
UMK063 B7681□P-F			X7R	680 p	±10, ±20	3.5	200	0.3±0.03	R	
UMK063 B7102□P-F			X7R	1000 p	±10, ±20	3.5	200	0.3±0.03	R	
TMK063 B7152□P-F			25	X7R	1500 p	±10, ±20	5	200	0.3±0.03	R
TMK063 B7222□P-F				X7R	2200 p	±10, ±20	5	200	0.3±0.03	R
TMK063 B7332□P-F				X7R	3300 p	±10, ±20	5	200	0.3±0.03	R
TMK063 B7472□P-F		X7R		4700 p	±10, ±20	5	200	0.3±0.03	R	
TMK063 B7682□P-F		X7R		6800 p	±10, ±20	5	200	0.3±0.03	R	
TMK063 B7103□P-F		X7R		0.01 μ	±10, ±20	5	200	0.3±0.03	R	
EMK063 B7152□P-F		16		X7R	1500 p	±10, ±20	5	200	0.3±0.03	R
EMK063 B7222□P-F				X7R	2200 p	±10, ±20	5	200	0.3±0.03	R
EMK063 B7332□P-F				X7R	3300 p	±10, ±20	5	200	0.3±0.03	R
EMK063 B7472□P-F				X7R	4700 p	±10, ±20	5	200	0.3±0.03	R
EMK063 B7682□P-F			X7R	6800 p	±10, ±20	5	200	0.3±0.03	R	
EMK063 B7103□P-F			X7R	0.01 μ	±10, ±20	5	200	0.3±0.03	R	
EMK063 B7152□P-F			4	X7R	0.022 μ	±10, ±20	7.5	150	0.3±0.03	R

► This catalog contains the typical specification only due to the limitation of space. When you consider the purchase of our products, please check our specification. For details of each product (characteristics graph, reliability information, precautions for use, and so on), see our Web site (<http://www.ty-top.com/>).

PARTS NUMBER

105TYPE

【Temperature Characteristic BJ : B/X5R】 0.5mm thickness(V)

Part number 1	Part number 2	Rated voltage [V]	Temperature characteristics		Capacitance [F]	Capacitance tolerance [%]	tan δ [%]	HTLT	Thickness*3 [mm]	Soldering R:Reflow W:Wave	
								Rated voltage x %			
UMK105 BJ221□V-F		50	B	X5R ⁺¹	220 p	±10, ±20	2.5	200	0.5±0.05	R	
UMK105 BJ331□V-F			B	X5R ⁺¹	330 p	±10, ±20	2.5	200	0.5±0.05	R	
UMK105 BJ471□V-F			B	X5R ⁺¹	470 p	±10, ±20	2.5	200	0.5±0.05	R	
UMK105 BJ681□V-F			B	X5R ⁺¹	680 p	±10, ±20	2.5	200	0.5±0.05	R	
UMK105 BJ102□V-F			B	X5R ⁺¹	1000 p	±10, ±20	2.5	200	0.5±0.05	R	
UMK105 BJ152□V-F			B	X5R ⁺¹	1500 p	±10, ±20	2.5	200	0.5±0.05	R	
UMK105 BJ222□V-F			B	X5R ⁺¹	2200 p	±10, ±20	2.5	200	0.5±0.05	R	
UMK105 BJ332□V-F			B	X5R ⁺¹	3300 p	±10, ±20	2.5	200	0.5±0.05	R	
UMK105 BJ472□V-F			B	X5R ⁺¹	4700 p	±10, ±20	2.5	200	0.5±0.05	R	
UMK105 BJ682□V-F			B	X5R ⁺¹	6800 p	±10, ±20	2.5	150	0.5±0.05	R	
UMK105 BJ103□V-F			B	X5R ⁺¹	0.01 μ	±10, ±20	3.5	200	0.5±0.05	R	
UMK105 BJ104□V-F				X5R	0.1 μ	±10, ±20	10	150	0.5±0.05	R	
UMK105 BJ224□V-F				X5R	0.22 μ	±10, ±20	10	150	0.5±0.05	R	
UMK105ABJ474□V-F				X5R	0.47 μ	±10, ±20	10	150	0.5±0.10	R	
UMK105CBJ105MV-F				X5R	1 μ	±20	10	150	0.5+0.20/-0	R	
GMK105 BJ104□V-F			35	B	X5R	0.1 μ	±10, ±20	5	150	0.5±0.05	R
GMK105ABJ105□V-F				X5R	1 μ	±10, ±20	10	150	0.5±0.10	R	
TMK105 BJ153□V-F			25	B	X5R ⁺¹	0.015 μ	±10, ±20	3.5	200	0.5±0.05	R
TMK105 BJ223□V-F				B	X5R ⁺¹	0.022 μ	±10, ±20	3.5	200	0.5±0.05	R
TMK105 BJ333□V-F				B	X5R ⁺¹	0.033 μ	±10, ±20	3.5	150	0.5±0.05	R
TMK105 BJ473□V-F		B		X5R ⁺¹	0.047 μ	±10, ±20	3.5	150	0.5±0.05	R	
TMK105 BJ104□V-F				X5R	0.1 μ	±10, ±20	5	150	0.5±0.05	R	
TMK105 BJ224□V-F				X5R	0.22 μ	±10, ±20	10	200	0.5±0.05	R	
TMK105ABJ474□V-F				X5R	0.47 μ	±10, ±20	10	200	0.5±0.10	R	
TMK105 BJ105□V-F				X5R	1 μ	±10, ±20	10	150	0.5±0.05	R	
TMK105CBJ225□V-F				X5R	2.2 μ	±10, ±20	10	150	0.5+0.20/-0	R	
EMK105 BJ153□V-F		16		B	X5R ⁺¹	0.015 μ	±10, ±20	3.5	200	0.5±0.05	R
EMK105 BJ223□V-F			B	X5R ⁺¹	0.022 μ	±10, ±20	3.5	200	0.5±0.05	R	
EMK105 BJ333□V-F			B	X5R ⁺¹	0.033 μ	±10, ±20	3.5	200	0.5±0.05	R	
EMK105 BJ473□V-F			B	X5R ⁺¹	0.047 μ	±10, ±20	3.5	200	0.5±0.05	R	
EMK105 BJ683□V-F			B	X5R	0.068 μ	±10, ±20	5	200	0.5±0.05	R	
EMK105 BJ104□V-F				X5R ⁺¹	0.1 μ	±10, ±20	5	150	0.5±0.05	R	
EMK105 BJ224□V-F				X5R	0.22 μ	±10, ±20	5	150	0.5±0.05	R	
EMK105ABJ474□V-F				X5R	0.47 μ	±10, ±20	10	150	0.5±0.10	R	
EMK105 BJ105□V-F				X5R	1 μ	±10, ±20	10	150	0.5±0.05	R	
EMK105ABJ225□V-F				X5R	2.2 μ	±10, ±20	10	150	0.5±0.10	R	
LMK105 BJ104□V-F		10	B	X5R	0.1 μ	±10, ±20	5	200	0.5±0.05	R	
LMK105 BJ224□V-F			B	X5R	0.22 μ	±10, ±20	5	150	0.5±0.05	R	
LMK105 BJ474□V-F				X5R	0.47 μ	±10, ±20	10	150	0.5±0.05	R	
LMK105 BJ105□V-F				X5R	1 μ	±10, ±20	10	150	0.5±0.05	R	
LMK105 BJ225□V-F				X5R	2.2 μ	±10, ±20	10	150	0.5±0.05	R	
LMK105BBJ475MVF				X5R	4.7 μ	±20	10	150	0.5+0.15/-0.05	R	
JMK105 BJ224□V-F		6.3	B	X5R	0.22 μ	±10, ±20	5	150	0.5±0.05	R	
JMK105 BJ474□V-F				X5R	0.47 μ	±10, ±20	10	150	0.5±0.05	R	
JMK105 BJ105□V-F				X5R	1 μ	±10, ±20	10	150	0.5±0.05	R	
JMK105 BJ225□V-F				X5R	2.2 μ	±10, ±20	10	150	0.5±0.05	R	
JMK105BBJ475MV-F	JMK105 BJ475MV-FD			X5R	4.7 μ	±20	10	150	0.5+0.15/-0.05	R	
JMK105CBJ106MV-F				X5R	10 μ	±20	10	150	0.5+0.20/-0	R	
AMK105ABJ475MV-F	AMK105 BJ475MV-F	4		X5R	4.7 μ	±20	10	150	0.5±0.10	R	
AMK105CBJ106MV-F				X5R	10 μ	±20	10	150	0.5+0.20/-0	R	

【Temperature Characteristic BJ : B/X5R】 0.3mm thickness(P)

Part number 1	Part number 2	Rated voltage [V]	Temperature characteristics		Capacitance [F]	Capacitance tolerance [%]	tan δ [%]	HTLT	Thickness*3 [mm]	Soldering R:Reflow W:Wave	
								Rated voltage x %			
UMK105 BJ104□P-F		50		X5R	0.1 μ	±10, ±20	10	150	0.3±0.03	R	
TMK105 BJ103□P-F				B	X5R	0.01 μ	±10, ±20	5	150	0.3±0.03	R
TMK105 BJ104□P-F		25		X5R	0.1 μ	±10, ±20	10	150	0.3±0.03	R	
TMK105 BJ224□P-F					X5R	0.22 μ	±10, ±20	10	150	0.3±0.03	R
TMK105 BJ474□P-F					X5R	0.47 μ	±10, ±20	10	150	0.3±0.03	R
EMK105 BJ474□P-F			16		X5R	0.47 μ	±10, ±20	10	150	0.3±0.03	R
LMK105 BJ105□PLF		10		X5R	1 μ	±10, ±20	10	150	0.3±0.03	R	
JMK105 BJ105□P-F		6.3		X5R	1 μ	±10, ±20	10	150	0.3±0.03	R	
AMK105 BJ225MP-F		4		X5R	2.2 μ	±20	10	150	0.3±0.03	R	

【Temperature Characteristic BJ : X5R】 0.2mm thickness(C)

Part number 1	Part number 2	Rated voltage [V]	Temperature characteristics		Capacitance [F]	Capacitance tolerance [%]	tan δ [%]	HTLT	Thickness*3 [mm]	Soldering R:Reflow W:Wave
								Rated voltage x %		
LMK105 BJ104□C-F		10		X5R	0.1 μ	±10, ±20	10	150	0.2±0.02	R
JMK105 BJ224□C-F					X5R	0.22 μ	±10, ±20	10	150	0.2±0.02
JMK105 BJ474□C-F		6.3		X5R	0.47 μ	±10, ±20	10	150	0.2±0.02	R
JMK105 BJ105MC-F					X5R	1 μ	±20	10	150	0.2±0.02

【Temperature Characteristic BJ : X5R】 0.18mm thickness(E)

Part number 1	Part number 2	Rated voltage [V]	Temperature characteristics		Capacitance [F]	Capacitance tolerance [%]	tan δ [%]	HTLT	Thickness*3 [mm]	Soldering R:Reflow W:Wave
								Rated voltage x %		
LMK105 BJ104□E-R		10		X5R	0.1 μ	±10, ±20	10	150	0.18±0.02	R
JMK105 BJ224□E-R		6.3		X5R	0.22 μ	±10, ±20	10	150	0.18±0.02	R
JMK105 BJ474□E-R					X5R	0.47 μ	±10, ±20	10	150	0.18±0.02
AMK105 BJ105ME-R		4		X5R	1 μ	±20	10	150	0.18±0.02	R

▶ This catalog contains the typical specification only due to the limitation of space. When you consider the purchase of our products, please check our specification. For details of each product (characteristics graph, reliability information, precautions for use, and so on), see our Web site (<http://www.ty-top.com/>).

■ PARTS NUMBER

【Temperature Characteristic BJ : X5R】 0.13mm thickness(H)

Part number 1	Part number 2	Rated voltage [V]	Temperature characteristics	Capacitance [F]	Capacitance tolerance [%]	tan δ [%]	HTLT		Soldering R:Reflow W:Wave
							Rated voltage x %	Thickness*3 [mm]	
LMK105 BJ104MH-R		10	X5R	0.1 μ	±20	10	150	0.13±0.02	R
JMK105 BJ224MH-R		6.3	X5R	0.22 μ	±20	10	150	0.13±0.02	R
AMK105 BJ474MH-R		4	X5R	0.47 μ	±20	10	150	0.13±0.02	R

【Temperature Characteristic C6 : X6S】 0.5mm thickness(V)

Part number 1	Part number 2	Rated voltage [V]	Temperature characteristics	Capacitance [F]	Capacitance tolerance [%]	tan δ [%]	HTLT		Soldering R:Reflow W:Wave
							Rated voltage x %	Thickness*3 [mm]	
GMK105CC6105MV-F		35	X6S	1 μ	±20	10	150	0.5+0.20/-0	R
TMK105AC6105[V-F		25	X6S	1 μ	±10, ±20	10	150	0.5±0.10	R
EMK105 C6105[V-F		16	X6S	1 μ	±10, ±20	10	150	0.5±0.05	R
EMK105CC6225MV-F			X6S	2.2 μ	±20	10	150	0.5+0.20/-0	R
LMK105 C6105[V-F		10	X6S	1 μ	±10, ±20	10	200	0.5±0.05	R
LMK105AC6225MV-F			X6S	2.2 μ	±20	10	150	0.5±0.10	R
JMK105 C6105[V-F		6.3	X6S	1 μ	±10, ±20	10	150	0.5±0.05	R
JMK105 C6225MV-F			X6S	2.2 μ	±20	10	150	0.5±0.05	R
JMK105BC6475MV-F			X6S	4.7 μ	±20	10	150	0.5+0.15/-0.05	R
AMK105BC6475MV-F		4	X6S	4.7 μ	±20	10	150	0.5+0.15/-0.05	R

【Temperature Characteristic B7 : X7R】 0.5mm thickness(V)

Part number 1	Part number 2	Rated voltage [V]	Temperature characteristics	Capacitance [F]	Capacitance tolerance [%]	tan δ [%]	HTLT		Soldering R:Reflow W:Wave	
							Rated voltage x %	Thickness*3 [mm]		
UMK105 B7221[V-F		50	X7R	220 p	±10, ±20	2.5	200	0.5±0.05	R	
UMK105 B7331[V-F			X7R	330 p	±10, ±20	2.5	200	0.5±0.05	R	
UMK105 B7471[V-F			X7R	470 p	±10, ±20	2.5	200	0.5±0.05	R	
UMK105 B7681[V-F			X7R	680 p	±10, ±20	2.5	200	0.5±0.05	R	
UMK105 B7102[V-F			X7R	1000 p	±10, ±20	2.5	200	0.5±0.05	R	
UMK105 B7152[V-F			X7R	1500 p	±10, ±20	2.5	200	0.5±0.05	R	
UMK105 B7222[V-F			X7R	2200 p	±10, ±20	2.5	200	0.5±0.05	R	
UMK105 B7332[V-F			X7R	3300 p	±10, ±20	2.5	200	0.5±0.05	R	
UMK105 B7472[V-F			X7R	4700 p	±10, ±20	2.5	200	0.5±0.05	R	
UMK105 B7682[V-F			X7R	6800 p	±10, ±20	2.5	200	0.5±0.05	R	
UMK105 B7103[V-F			X7R	0.01 μ	±10, ±20	3.5	200	0.5±0.05	R	
UMK105 B7223[V-FR			X7R	0.022 μ	±10, ±20	10	200	0.5±0.05	R	
UMK105 B7473[V-FR			X7R	0.047 μ	±10, ±20	10	200	0.5±0.05	R	
UMK105 B7104[V-FR			X7R	0.1 μ	±10, ±20	10	150	0.5±0.05	R	
TMK105 B7152[V-F		25	X7R	1500 p	±10, ±20	2.5	200	0.5±0.05	R	
TMK105 B7222[V-F			X7R	2200 p	±10, ±20	2.5	200	0.5±0.05	R	
TMK105 B7332[V-F			X7R	3300 p	±10, ±20	2.5	200	0.5±0.05	R	
TMK105 B7472[V-F			X7R	4700 p	±10, ±20	2.5	200	0.5±0.05	R	
TMK105 B7682[V-F			X7R	6800 p	±10, ±20	2.5	200	0.5±0.05	R	
TMK105 B7103[V-F			X7R	0.01 μ	±10, ±20	3.5	200	0.5±0.05	R	
TMK105 B7223[V-F			X7R	0.022 μ	±10, ±20	3.5	150	0.5±0.05	R	
TMK105 B7473[V-F			X7R	0.047 μ	±10, ±20	3.5	150	0.5±0.05	R	
TMK105 B7104[V-FR			X7R	0.1 μ	±10, ±20	10	200	0.5±0.05	R	
TMK105 B7224[V-FR			X7R	0.22 μ	±10, ±20	10	150	0.5±0.05	R	
EMK105 B7223[V-F			16	X7R	0.022 μ	±10, ±20	3.5	200	0.5±0.05	R
EMK105 B7473[V-F				X7R	0.047 μ	±10, ±20	3.5	200	0.5±0.05	R
EMK105 B7104[V-F				X7R	0.1 μ	±10, ±20	5	150	0.5±0.05	R
EMK105 B7224[V-FR				X7R	0.22 μ	±10, ±20	10	150	0.5±0.05	R
LMK105 B7223[V-F		10	X7R	0.022 μ	±10, ±20	3.5	200	0.5±0.05	R	
LMK105 B7473[V-F			X7R	0.047 μ	±10, ±20	3.5	200	0.5±0.05	R	
LMK105 B7104[V-F			X7R	0.1 μ	±10, ±20	5	150	0.5±0.05	R	
LMK105 B7224[V-FR			X7R	0.22 μ	±10, ±20	10	150	0.5±0.05	R	
LMK105 B7474[V-F		6.3	X7R	0.47 μ	±10, ±20	10	150	0.5±0.05	R	
JMK105 B7224[V-F			X7R	0.22 μ	±10, ±20	5	150	0.5±0.05	R	
JMK105 B7474[V-F		X7R	0.47 μ	±10, ±20	10	150	0.5±0.05	R		

【Temperature Characteristic F : F/Y5V】 0.5mm thickness(V)

Part number 1	Part number 2	Rated voltage [V]	Temperature characteristics		Capacitance [F]	Capacitance tolerance [%]	tan δ [%]	HTLT		Soldering R:Reflow W:Wave
			F	Y5V				Rated voltage x %	Thickness*3 [mm]	
UMK105 F103ZV-F		50	F	Y5V	0.01 μ	+80/-20	5	200	0.5±0.05	R
TMK105 F223ZV-F		25	F	Y5V	0.022 μ	+80/-20	5	200	0.5±0.05	R
EMK105 F473ZV-F		16	F	Y5V	0.047 μ	+80/-20	7	200	0.5±0.05	R
EMK105 F104ZV-F			F	Y5V	0.1 μ	+80/-20	9	200	0.5±0.05	R
LMK105 F224ZV-F		10	F	Y5V	0.22 μ	+80/-20	11	200	0.5±0.05	R
JMK105 F474ZV-F		6.3	F	Y5V	0.47 μ	+80/-20	12.5	200	0.5±0.05	R
JMK105 F105ZV-F			F	Y5V	1 μ	+80/-20	20	150	0.5±0.05	R

● 107TYPE

【Temperature Characteristic BJ : B/X5R】 0.8mm thickness(A)

Part number 1	Part number 2	Rated voltage [V]	Temperature characteristics		Capacitance [F]	Capacitance tolerance [%]	tan δ [%]	HTLT		Soldering R:Reflow W:Wave	
			B	X5R				Rated voltage x %	Thickness*3 [mm]		
UMK107ABJ474[A-T	UMK107 BJ474[A-TD	50		X5R	0.47 μ	±10, ±20	10	150	0.8+0.15/-0.05	R	
UMK107 BJ105[A-T				X5R	1 μ	±10, ±20	10	150	0.8±0.10	R	
UMK107BBJ225[A-T				X5R	2.2 μ	±10, ±20	10	150	0.8+0.20/-0	R	
GMK107 BJ105[A-T		35	B	X5R	1 μ	±10, ±20	5	150	0.8±0.10	R	
TMK107 BJ224[A-T		25	B	X5R	0.22 μ	±10, ±20	3.5	200	0.8±0.10	R/W	
TMK107 BJ474[A-T			B	X5R	0.47 μ	±10, ±20	3.5	150	0.8±0.10	R	
TMK107 BJ105[A-T			B	X5R	1 μ	±10, ±20	5	150	0.8±0.10	R	
TMK107ABJ225[A-T	TMK107 BJ225[A-TD				X5R	2.2 μ	±10, ±20	10	150	0.8+0.15/-0.05	R
TMK107BBJ475[A-T					X5R	4.7 μ	±10, ±20	10	150	0.8+0.20/-0	R
TMK107BBJ106MA-T					X5R	10 μ	±20	10	150	0.8+0.20/-0	R

▶ This catalog contains the typical specification only due to the limitation of space. When you consider the purchase of our products, please check our specification. For details of each product (characteristics graph, reliability information, precautions for use, and so on), see our Web site (<http://www.ty-top.com/>).

PARTS NUMBER

Part number 1	Part number 2	Rated voltage [V]	Temperature characteristics		Capacitance [F]	Capacitance tolerance [%]	tan δ [%]	HTLT		Thickness*3 [mm]	Soldering R:Reflow W:Wave
								Rated voltage x %			
EMK107 BJ224[A-T]		16	B	X5R ⁺¹	0.22 μ	±10, ±20	3.5	200	0.8±0.10	R/W	
EMK107 BJ474[A-T]			B	X5R ⁺¹	0.47 μ	±10, ±20	3.5	200	0.8±0.10	R	
EMK107 BJ105[A-T]			B	X5R ⁺¹	1 μ	±10, ±20	5	150	0.8±0.10	R	
EMK107 BJ225[A-T]			B	X5R	2.2 μ	±10, ±20	10	150	0.8±0.10	R	
EMK107ABJ475[A-T]	EMK107 BJ475[A-TD]				X5R	4.7 μ	±10, ±20	10	150	0.8+0.15/-0.05	R
EMK107BBJ106MA-T					X5R	10 μ	±20	10	150	0.8+0.20/-0	R
LMK107 BJ224[A-T]		10	B	X5R ⁺¹	0.22 μ	±10, ±20	3.5	200	0.8±0.10	R/W	
LMK107 BJ474[A-T]			B	X5R ⁺¹	0.47 μ	±10, ±20	3.5	200	0.8±0.10	R	
LMK107 BJ105[A-T]			B	X5R ⁺¹	1 μ	±10, ±20	5	200	0.8±0.10	R	
LMK107 BJ225[A-T]			B	X5R ⁺¹	2.2 μ	±10, ±20	10	150	0.8±0.10	R	
LMK107 BJ475[A-T]					X5R	4.7 μ	±10, ±20	10	150	0.8±0.10	R
LMK107BBJ106MALTD	LMK107 BJ106MALTD				X5R	10 μ	±20	10	150	0.8+0.20/-0	R
JMK107 BJ225[A-T]		6.3	B	X5R	2.2 μ	±10, ±20	10	150	0.8±0.10	R	
JMK107 BJ475[A-T]					X5R	4.7 μ	±10, ±20	10	150	0.8±0.10	R
JMK107ABJ106MA-T	JMK107 BJ106MA-T				X5R	10 μ	±20	10	150	0.8+0.15/-0.05	R
JMK107BBJ226MA-T					X5R	2.2 μ	±20	10	150	0.8+0.20/-0	R
AMK107 BJ106MA-T					X5R	10 μ	±20	10	150	0.8±0.10	R
AMK107BBJ226MA-T	AMK107 BJ226MA-T		4		X5R	2.2 μ	±20	10	150	0.8+0.20/-0	R

【Temperature Characteristic BJ : B/X5R】 0.45mm thickness (K)

Part number 1	Part number 2	Rated voltage [V]	Temperature characteristics		Capacitance [F]	Capacitance tolerance [%]	tan δ [%]	HTLT		Thickness*3 [mm]	Soldering R:Reflow W:Wave
								Rated voltage x %			
TMK107 BJ105[K-T]		25		X5R	1 μ	±10, ±20	10	150	0.45±0.05	R	
EMK107 BJ105[K-T]		16		X5R	1 μ	±10, ±20	10	150	0.45±0.05	R	
EMK107BBJ225[K-T]					X5R	2.2 μ	±10, ±20	10	150	0.45±0.05	R
LMK107 BJ105[K-T]		10	B	X5R	1 μ	±10, ±20	10	150	0.45±0.05	R	
LMK107 BJ225[K-T]					X5R	2.2 μ	±10, ±20	10	150	0.45±0.05	R
LMK107BBJ475MKLT	LMK107 BJ475MKLTD			X5R	4.7 μ	±20	10	150	0.45±0.05	R	
JMK107 BJ105[K-T]		6.3	B	X5R	1 μ	±10, ±20	10	150	0.45±0.05	R	
JMK107 BJ225[K-T]					X5R	2.2 μ	±10, ±20	10	150	0.45±0.05	R
JMK107 BJ475MK-T					X5R	4.7 μ	±20	10	150	0.45±0.05	R
JMK107BBJ106MK-T*2		4		X5R	10 μ	±20	10	150	0.45±0.05	R	
AMK107BBJ106MK-T*2	AMK107 BJ106MK-T*2				X5R	10 μ	±20	10	150	0.45±0.05	R

【Temperature Characteristic C6 : X6S】 0.8mm thickness (A)

Part number 1	Part number 2	Rated voltage [V]	Temperature characteristics		Capacitance [F]	Capacitance tolerance [%]	tan δ [%]	HTLT		Thickness*3 [mm]	Soldering R:Reflow W:Wave
								Rated voltage x %			
TMK107BC6225[A-T]		25		X6S	2.2 μ	±10, ±20	10	150	0.8+0.20/-0	R	
EMK107 C6105[A-T]		16		X6S	1 μ	±10, ±20	5	150	0.8±0.10	R	
EMK107BC6225[A-T]					X6S	2.2 μ	±10, ±20	10	150	0.8+0.20/-0	R
EMK107BC6475[A-T]					X6S	4.7 μ	±10, ±20	10	150	0.8+0.20/-0	R
EMK107BC6106MA-T					X6S	10 μ	±20	10	150	0.8+0.20/-0	R
LMK107 C6105[A-T]		10		X6S	1 μ	±10, ±20	5	150	0.8±0.10	R	
LMK107AC6475[A-T]					X6S	4.7 μ	±10, ±20	10	150	0.8+0.15/-0.05	R
LMK107BC6106MA-T					X6S	10 μ	±20	10	150	0.8+0.20/-0	R
JMK107 C6105[A-T]		6.3		X6S	1 μ	±10, ±20	5	150	0.8±0.10	R	
JMK107 C6475[A-T]					X6S	4.7 μ	±10, ±20	10	150	0.8±0.10	R
JMK107BC6106MA-T					X6S	10 μ	±20	10	150	0.8+0.20/-0	R
AMK107AC6106MA-T			4		X6S	10 μ	±20	10	150	0.8+0.15/-0.05	R
AMK107BC6226MA-T	AMK107BC6226MA-T				X6S	2.2 μ	±20	10	150	0.8+0.20/-0	R

【Temperature Characteristic B7 : X7R】 0.8mm thickness (A)

Part number 1	Part number 2	Rated voltage [V]	Temperature characteristics		Capacitance [F]	Capacitance tolerance [%]	tan δ [%]	HTLT		Thickness*3 [mm]	Soldering R:Reflow W:Wave	
								Rated voltage x %				
UMK107 B7224[A-TR]		50		X7R	0.22 μ	±10, ±20	10	150	0.8±0.10	R		
UMK107 B7474[A-TR]					X7R	0.47 μ	±10, ±20	10	150	0.8±0.10	R	
UMK107AB7105[A-T]					X7R	1 μ	±10, ±20	10	150	0.8+0.15/-0.05	R	
TMK107 B7474[A-TR]			25		X7R	0.47 μ	±10, ±20	10	150	0.8±0.10	R	
TMK107 B7105[A-T]						X7R	1 μ	±10, ±20	10	150	0.8±0.10	R
EMK107 B7224[A-T]						X7R	0.22 μ	±10, ±20	3.5	150	0.8±0.10	R/W
EMK107 B7474[A-T]		16		X7R	0.47 μ	±10, ±20	3.5	150	0.8±0.10	R		
EMK107 B7105[A-T]					X7R	1 μ	±10, ±20	5	150	0.8±0.10	R	
EMK107BB7225[A-T]					X7R	2.2 μ	±10, ±20	10	150	0.8+0.20/-0	R	
LMK107 B7224[A-T]			10		X7R	0.22 μ	±10, ±20	3.5	200	0.8±0.10	R/W	
LMK107 B7474[A-T]					X7R	0.47 μ	±10, ±20	3.5	200	0.8±0.10	R	
LMK107 B7105[A-T]					X7R	1 μ	±10, ±20	5	150	0.8±0.10	R	
LMK107 B7225[A-TR]					X7R	2.2 μ	±10, ±20	10	150	0.8±0.10	R	
JMK107 B7224[A-T]		6.3			X7R	0.22 μ	±10, ±20	3.5	200	0.8±0.10	R/W	
JMK107 B7474[A-T]						X7R	0.47 μ	±10, ±20	3.5	200	0.8±0.10	R
JMK107 B7105[A-T]					X7R	1 μ	±10, ±20	5	150	0.8±0.10	R	
JMK107 B7225[A-TR]					X7R	2.2 μ	±10, ±20	10	200	0.8±0.10	R	
JMK107BB7475[A-T]					X7R	4.7 μ	±10, ±20	10	150	0.8+0.20/-0	R	

【Temperature Characteristic F : F/Y5V】 0.8mm thickness (A)

Part number 1	Part number 2	Rated voltage [V]	Temperature characteristics		Capacitance [F]	Capacitance tolerance [%]	tan δ [%]	HTLT		Thickness*3 [mm]	Soldering R:Reflow W:Wave	
								Rated voltage x %				
UMK107 F104ZA-T		50	F	Y5V	0.1 μ	+80/-20	7	200	0.8±0.10	R/W		
TMK107 F474ZA-T		25	F	Y5V	0.47 μ	+80/-20	7	200	0.8±0.10	R/W		
EMK107 F224ZA-T				F	Y5V	0.22 μ	+80/-20	7	200	0.8±0.10	R/W	
EMK107 F474ZA-T				F	Y5V	0.47 μ	+80/-20	7	200	0.8±0.10	R/W	
EMK107 F105ZA-T			16	F	Y5V	1 μ	+80/-20	16	200	0.8±0.10	R	
EMK107 F225ZA-T					F	Y5V	2.2 μ	+80/-20	16	200	0.8±0.10	R
LMK107 F105ZA-T				10	F	Y5V	1 μ	+80/-20	16	200	0.8±0.10	R
LMK107 F225ZA-T			F		Y5V	2.2 μ	+80/-20	16	200	0.8±0.10	R	

▶ This catalog contains the typical specification only due to the limitation of space. When you consider the purchase of our products, please check our specification. For details of each product (characteristics graph, reliability information, precautions for use, and so on), see our Web site (<http://www.ty-top.com/>).

PARTS NUMBER

● 212TYPE

[Temperature Characteristic BJ : B/X5R] 1.25mm thickness (G)

Part number 1	Part number 2	Rated voltage [V]	Temperature characteristics	Capacitance [F]	Capacitance tolerance [%]	tan δ [%]	HTLT		Thickness ^{*3} [mm]	Soldering R:Reflow W:Wave
							Rated voltage x %			
UMK212 BJ104[G-T		50	B X5R ¹	0.1 μ	±10, ±20	3.5	200	1.25±0.10	R/W	
UMK212 BJ224[G-T			B X5R ¹	0.22 μ	±10, ±20	3.5	200	1.25±0.10	R/W	
UMK212 BJ474[G-T			B X5R ¹	0.47 μ	±10, ±20	3.5	150	1.25±0.10	R/W	
UMK212 BJ105[G-T			B X5R	1 μ	±10, ±20	5	150	1.25±0.10	R/W	
UMK212ABJ225[G-T			X5R	2.2 μ	±10, ±20	10	150	1.25+0.15/-0.05	R	
UMK212BBJ475[G-T			X5R	4.7 μ	±10, ±20	10	150	1.25+0.20/-0	R	
GMK212BBJ106[G-T		35	X5R	10 μ	±10, ±20	10	150	1.25+0.20/-0	R	
TMK212 BJ225[G-T			B X5R	2.2 μ	±10, ±20	5	150	1.25±0.10	R	
TMK212ABJ475[G-T	TMK212 BJ475[G-T		25	X5R	4.7 μ	±10, ±20	10	150	1.25+0.15/-0.05	R
TMK212BBJ106MG-T			X5R	10 μ	±20	10	150	1.25+0.20/-0	R	
EMK212 BJ225[G-T		16	B X5R ¹	2.2 μ	±10, ±20	5	200	1.25±0.10	R	
EMK212ABJ475[G-T	EMK212 BJ475[G-T		B X5R ¹	4.7 μ	±10, ±20	5	150	1.25+0.15/-0.05	R	
EMK212ABJ106[G-T	EMK212 BJ106[G-T		X5R	10 μ	±10, ±20	10	150	1.25+0.15/-0.05	R	
EMK212BBJ226MG-T			X5R	22 μ	±20	10	150	1.25+0.20/-0	R	
LMK212 BJ225[G-T			B X5R ¹	2.2 μ	±10, ±20	5	200	1.25±0.10	R	
LMK212ABJ475[G-T	LMK212 BJ475[G-T		10	B X5R ¹	4.7 μ	±10, ±20	5	200	1.25+0.15/-0.05	R
LMK212ABJ106[G-T	LMK212 BJ106[G-T		X5R	10 μ	±10, ±20	10	200	1.25+0.15/-0.05	R	
LMK212BBJ226MG-T	LMK212 BJ226MG-T		X5R	22 μ	±20	10	150	1.25+0.20/-0	R	
JMK212ABJ475[G-T	JMK212 BJ475[G-T	6.3	B X5R	4.7 μ	±10, ±20	5	200	1.25+0.15/-0.05	R	
JMK212ABJ106[G-T	JMK212 BJ106[G-T		X5R ¹	10 μ	±10, ±20	10	200	1.25+0.15/-0.05	R	
JMK212ABJ226MG-T	JMK212 BJ226MG-T		X5R	22 μ	±20	10	150	1.25+0.15/-0.05	R	
JMK212BBJ476MG-T	JMK212 BJ476MG-T		X5R	47 μ	±20	10	150	1.25+0.20/-0	R	
PMK212BBJ107MG-T			2.5	X5R	100 μ	±20	10	150	1.25+0.20/-0	R

[Temperature Characteristic BJ : B/X5R] 0.85mm thickness (D)

Part number 1	Part number 2	Rated voltage [V]	Temperature characteristics	Capacitance [F]	Capacitance tolerance [%]	tan δ [%]	HTLT		Thickness ^{*3} [mm]	Soldering R:Reflow W:Wave
							Rated voltage x %			
UMK212ABJ105[D-T	UMK212 BJ105[D-TD	50	X5R	1 μ	±10, ±20	10	150	0.85±0.10	R	
UMK212BBJ225[D-T			X5R	2.2 μ	±10, ±20	10	150	0.85±0.10	R	
GMK212BBJ475[D-T		35	X5R	4.7 μ	±10, ±20	10	150	0.85±0.10	R	
TMK212 BJ474[D-T			B X5R	0.47 μ	±10, ±20	3.5	200	0.85±0.10	R	
TMK212 BJ105[D-T			B X5R	1 μ	±10, ±20	5	200	0.85±0.10	R	
TMK212ABJ225[D-T	TMK212 BJ225[D-T	25	B X5R	2.2 μ	±10, ±20	5	150	0.85±0.10	R	
TMK212BBJ475[D-T	TMK212 BJ475[D-TD		X5R	4.7 μ	±10, ±20	10	150	0.85±0.10	R	
TMK212BBJ106[D-T			X5R	10 μ	±10, ±20	10	150	0.85±0.10	R	
EMK212 BJ105[D-T		16	B X5R ¹	1 μ	±10, ±20	5	200	0.85±0.10	R	
EMK212ABJ225[D-T	EMK212 BJ225[D-T		B X5R ¹	2.2 μ	±10, ±20	5	150	0.85±0.10	R	
EMK212 BJ475[D-T			B X5R	4.7 μ	±10, ±20	10	150	0.85±0.10	R	
EMK212ABJ106[D-T	EMK212 BJ106[D-TD		X5R	10 μ	±10, ±20	10	150	0.85±0.10	R	
LMK212 BJ105[D-T			B X5R ¹	1 μ	±10, ±20	3.5	200	0.85±0.10	R	
LMK212 BJ225[D-T			B X5R ¹	2.2 μ	±10, ±20	5	200	0.85±0.10	R	
LMK212 BJ475[D-T		10	B X5R	4.7 μ	±10, ±20	10	200	0.85±0.10	R	
LMK212ABJ106[D-T	LMK212 BJ106[D-T		X5R	10 μ	±10, ±20	10	150	0.85±0.10	R	
LMK212BBJ226MD-T			X5R	22 μ	±20	10	150	0.85±0.10	R	
JMK212 BJ475[D-T		6.3	X5R	4.7 μ	±10, ±20	10	200	0.85±0.10	R	
JMK212ABJ106[D-T	JMK212 BJ106[D-T		X5R	10 μ	±10, ±20	10	200	0.85±0.10	R	
JMK212ABJ226MD-T	JMK212 BJ226MD-T		X5R	22 μ	±20	10	150	0.85±0.10	R	
AMK212BBJ476MD-T			X5R	47 μ	±20	10	150	0.85±0.10	R	

[Temperature Characteristic BJ : X5R] 0.45mm thickness (K)

Part number 1	Part number 2	Rated voltage [V]	Temperature characteristics	Capacitance [F]	Capacitance tolerance [%]	tan δ [%]	HTLT		Thickness ^{*3} [mm]	Soldering R:Reflow W:Wave
							Rated voltage x %			
TMK212BBJ225[K-T		25	X5R	2.2 μ	±10, ±20	10	150	0.45±0.05	R	
EMK212BBJ475[K-T			X5R	4.7 μ	±10, ±20	10	150	0.45±0.05	R	
LMK212ABJ475[K-T	LMK212 BJ475[K-T	10	X5R	4.7 μ	±10, ±20	10	150	0.45±0.05	R	
JMK212ABJ475[K-T	JMK212 BJ475[K-T		6.3	X5R	4.7 μ	±10, ±20	10	150	0.45±0.05	R
JMK212ABJ106MK-T *2	JMK212 BJ106MK-T		X5R	10 μ	±20	10	150	0.45±0.05	R	

[Temperature Characteristic C6 : X6S] 1.25mm thickness (G)

Part number 1	Part number 2	Rated voltage [V]	Temperature characteristics	Capacitance [F]	Capacitance tolerance [%]	tan δ [%]	HTLT		Thickness ^{*3} [mm]	Soldering R:Reflow W:Wave
							Rated voltage x %			
LMK212BC6226MG-T		10	X6S	22 μ	±20	10	150	1.25+0.20/-0	R	
JMK212BC6226MG-T			X6S	22 μ	±20	10	150	1.25+0.20/-0	R	
AMK212AC6226MG-T		4	X6S	22 μ	±20	10	150	1.25+0.15/-0.05	R	
AMK212BC6476MG-T			X6S	47 μ	±20	10	150	1.25+0.20/-0	R	

[Temperature Characteristic C6 : X6S] 0.85mm thickness (D)

Part number 1	Part number 2	Rated voltage [V]	Temperature characteristics	Capacitance [F]	Capacitance tolerance [%]	tan δ [%]	HTLT		Thickness ^{*3} [mm]	Soldering R:Reflow W:Wave
							Rated voltage x %			
LMK212AC6106[D-T		10	X6S	10 μ	±10, ±20	10	150	0.85±0.10	R	
AMK212BC6226MD-T			X6S	22 μ	±20	10	150	0.85±0.10	R	

[Temperature Characteristic B7 : X7R] 1.25mm thickness (G)

Part number 1	Part number 2	Rated voltage [V]	Temperature characteristics	Capacitance [F]	Capacitance tolerance [%]	tan δ [%]	HTLT		Thickness ^{*3} [mm]	Soldering R:Reflow W:Wave
							Rated voltage x %			
UMK212 B7104[G-T		50	X7R	0.1 μ	±10, ±20	3.5	200	1.25±0.10	R/W	
UMK212 B7224[G-T			X7R	0.22 μ	±10, ±20	3.5	150	1.25±0.10	R/W	
UMK212 B7474[G-T			X7R	0.47 μ	±10, ±20	3.5	150	1.25±0.10	R/W	
UMK212 B7105[G-T			X7R	1 μ	±10, ±20	10	150	1.25±0.10	R/W	
UMK212BBB7225[G-T			X7R	2.2 μ	±10, ±20	10	150	1.25+0.20/-0	R	
GMK212 B7105[G-T			35	X7R	1 μ	±10, ±20	3.5	150	1.25±0.10	R/W
TMK212 B7105[G-T		25	X7R	1 μ	±10, ±20	3.5	150	1.25±0.10	R	
TMK212 B7225[G-TR			X7R	2.2 μ	±10, ±20	10	150	1.25±0.10	R	
TMK212AB7475[G-T	TMK212 B7475[G-T		X7R	4.7 μ	±10, ±20	10	150	1.25+0.15/-0.05	R	

► This catalog contains the typical specification only due to the limitation of space. When you consider the purchase of our products, please check our specification. For details of each product (characteristics graph, reliability information, precautions for use, and so on), see our Web site (<http://www.ty-top.com/>).

CERAMIC CAPACITORS

PARTS NUMBER

Part number 1	Part number 2	Rated voltage [V]	Temperature characteristics		Capacitance [F]	Capacitance tolerance [%]	tan δ [%]	HTLT	Thickness*3 [mm]	Soldering R:Reflow W:Wave
								Rated voltage x %		
EMK212 B7105□G-T		16	X7R		1 μ	±10, ±20	3.5	200	1.25±0.10	R/W
EMK212 B7225□G-T					2.2 μ	±10, ±20	10	150	1.25±0.10	R
EMK212 B7475□G-T					4.7 μ	±10, ±20	10	150	1.25±0.10	R
EMK212BB7106MG-T					10 μ	±20	10	150	1.25±0.20/-0	R
LMK212 B7105□G-T		10	X7R		1 μ	±10, ±20	3.5	200	1.25±0.10	R/W
LMK212 B7225□G-T					2.2 μ	±10, ±20	5	200	1.25±0.10	R
LMK212 B7475□G-T					4.7 μ	±10, ±20	10	150	1.25±0.10	R
LMK212AB7106□G-T	LMK212 B7106□G-TD				10 μ	±10, ±20	10	150	1.25±0.15/-0.05	R
JMK212AB7106□G-T	JMK212 B7106□G-T	6.3	X7R		10 μ	±10, ±20	10	150	1.25±0.15/-0.05	R

【Temperature Characteristic B7 : X7R】 0.85mm thickness (D)

Part number 1	Part number 2	Rated voltage [V]	Temperature characteristics		Capacitance [F]	Capacitance tolerance [%]	tan δ [%]	HTLT	Thickness*3 [mm]	Soldering R:Reflow W:Wave
								Rated voltage x %		
UMK212AB7104□D-T		50	X7R		0.1 μ	±10, ±20	10	150	0.85±0.10	R
UMK212AB7224□D-T					0.22 μ	±10, ±20	10	150	0.85±0.10	R
UMK212AB7474□D-T					0.47 μ	±10, ±20	10	150	0.85±0.10	R
UMK212AB7105□D-T					1 μ	±10, ±20	10	150	0.85±0.10	R
TMK212AB7225□D-TR		25	X7R		2.2 μ	±10, ±20	10	150	0.85±0.10	R
EMK212 B7474□D-T					0.47 μ	±10, ±20	3.5	200	0.85±0.10	R/W
EMK212 B7105□D-T		16	X7R		1 μ	±10, ±20	5	200	0.85±0.10	R
EMK212AB7225□D-T	EMK212 B7225□D-T				2.2 μ	±10, ±20	5	150	0.85±0.10	R
EMK212BB7475□D-T					4.7 μ	±10, ±20	10	150	0.85±0.10	R
LMK212 B7105□D-T					1 μ	±10, ±20	3.5	200	0.85±0.10	R
LMK212AB7225□D-T	LMK212 B7225□D-T	10	X7R		2.2 μ	±10, ±20	5	200	0.85±0.10	R
LMK212AB7475□D-TR	LMK212 B7475□D-TR				4.7 μ	±10, ±20	10	150	0.85±0.10	R

【Temperature Characteristic F : F/Y5V】 1.25mm thickness (G)

Part number 1	Part number 2	Rated voltage [V]	Temperature characteristics		Capacitance [F]	Capacitance tolerance [%]	tan δ [%]	HTLT	Thickness*3 [mm]	Soldering R:Reflow W:Wave
								Rated voltage x %		
UMK212 F474ZG-T		50	F	Y5V	0.47 μ	+80/-20	7	200	1.25±0.10	R/W
UMK212 F105ZG-T					1 μ	+80/-20	7	200	1.25±0.10	R/W
EMK212 F225ZG-T		16	F	Y5V	2.2 μ	+80/-20	7	200	1.25±0.10	R/W
LMK212 F475ZG-T		10	F	Y5V	4.7 μ	+80/-20	9	200	1.25±0.10	R
LMK212 F106ZG-T					10 μ	+80/-20	16	200	1.25±0.10	R
JMK212 F106ZG-T		6.3	F	Y5V	10 μ	+80/-20	16	200	1.25±0.10	R

【Temperature Characteristic F : F/Y5V】 0.85mm thickness (D)

Part number 1	Part number 2	Rated voltage [V]	Temperature characteristics		Capacitance [F]	Capacitance tolerance [%]	tan δ [%]	HTLT	Thickness*3 [mm]	Soldering R:Reflow W:Wave
								Rated voltage x %		
UMK212 F224ZD-T		50	F	Y5V	0.22 μ	+80/-20	7	200	0.85±0.10	R/W
LMK212 F225ZD-T		10	F	Y5V	2.2 μ	+80/-20	9	200	0.85±0.10	R
JMK212 F475ZD-T		6.3	F	Y5V	4.7 μ	+80/-20	16	200	0.85±0.10	R

316TYPE

【Temperature Characteristic BJ : B/Y5R】 1.6mm thickness (L)

Part number 1	Part number 2	Rated voltage [V]	Temperature characteristics		Capacitance [F]	Capacitance tolerance [%]	tan δ [%]	HTLT	Thickness*3 [mm]	Soldering R:Reflow W:Wave
								Rated voltage x %		
UMK316 BJ105□L-T		50	B	X5R ⁺	1 μ	±10, ±20	3.5	200	1.6±0.20	R
UMK316 BJ225□L-T					2.2 μ	±10, ±20	10	150	1.6±0.20	R
UMK316 BJ475□L-T					4.7 μ	±10, ±20	10	150	1.6±0.20	R
UMK316BBJ106□L-T					10 μ	±10, ±20	10	150	1.6±0.30	R
TMK316 BJ225□L-T		25	B	X5R ⁺	2.2 μ	±10, ±20	3.5	200	1.6±0.20	R
TMK316 BJ475□L-T					4.7 μ	±10, ±20	5	150	1.6±0.20	R
TMK316 BJ106□L-T					10 μ	±10, ±20	5	150	1.6±0.20	R
TMK316BBJ226ML-T					22 μ	±20	10	150	1.6±0.30	R
EMK316 BJ225□L-T		16	B	X5R ⁺	2.2 μ	±10, ±20	3.5	200	1.6±0.20	R/W
EMK316 BJ475□L-T					4.7 μ	±10, ±20	5	200	1.6±0.20	R
EMK316 BJ106□L-T					10 μ	±10, ±20	5	150	1.6±0.20	R
EMK316ABJ226□L-T	EMK316 BJ226□L-T				22 μ	±10, ±20	10	150	1.6±0.20	R
LMK316 BJ106□L-T		10	B	X5R ⁺	10 μ	±10, ±20	5	200	1.6±0.20	R
LMK316ABJ226□L-T	LMK316 BJ226□L-T				22 μ	±10, ±20	10	150	1.6±0.20	R
LMK316ABJ476ML-T	LMK316 BJ476ML-T				47 μ	±20	10	150	1.6±0.20	R
JMK316 BJ106□L-T					10 μ	±10, ±20	5	200	1.6±0.20	R
JMK316ABJ226□L-T	JMK316 BJ226□L-T	6.3	B	X5R	22 μ	±10, ±20	10	200	1.6±0.20	R
JMK316ABJ476ML-T	JMK316 BJ476ML-T				47 μ	±20	10	200	1.6±0.20	R
JMK316ABJ107ML-T	JMK316 BJ107ML-T				100 μ	±20	10	150	1.6±0.20	R
AMK316ABJ107ML-T	AMK316 BJ107ML-T				100 μ	±20	10	150	1.6±0.20	R
AMK316BBJ157ML-T		4	X5R		150 μ	±20	10	150	1.6±0.30	R
PMK316BBJ227ML-T					220 μ	±20	10	150	1.6±0.30	R

【Temperature Characteristic BJ : B/Y5R】 0.85mm thickness (D)

Part number 1	Part number 2	Rated voltage [V]	Temperature characteristics		Capacitance [F]	Capacitance tolerance [%]	tan δ [%]	HTLT	Thickness*3 [mm]	Soldering R:Reflow W:Wave
								Rated voltage x %		
UMK316 BJ105□D-T		50	B	X5R	1 μ	±10, ±20	3.5	150	0.85±0.10	R
UMK316 BJ225□D-T					2.2 μ	±10, ±20	3.5	150	0.85±0.10	R
UMK316ABJ475□D-T	UMK316 BJ475□D-T				4.7 μ	±10, ±20	10	150	0.85±0.10	R
TMK316 BJ105□D-T					1 μ	±10, ±20	3.5	200	0.85±0.10	R
TMK316 BJ225□D-T		25	B	X5R	2.2 μ	±10, ±20	3.5	150	0.85±0.10	R
TMK316 BJ475□D-T					4.7 μ	±10, ±20	5	150	0.85±0.10	R
TMK316ABJ106□D-T	TMK316 BJ106□D-TD				10 μ	±10, ±20	10	150	0.85±0.10	R
EMK316 BJ225□D-T					2.2 μ	±10, ±20	3.5	200	0.85±0.10	R
EMK316 BJ475□D-T		16	B	X5R	4.7 μ	±10, ±20	5	200	0.85±0.10	R
EMK316 BJ106□D-T					10 μ	±10, ±20	10	150	0.85±0.10	R
EMK316ABJ226MD-T	EMK316 BJ226MD-T				22 μ	±20	10	150	0.85±0.10	R

▶ This catalog contains the typical specification only due to the limitation of space. When you consider the purchase of our products, please check our specification. For details of each product (characteristics graph, reliability information, precautions for use, and so on), see our Web site (<http://www.ty-top.com/>).

■ PARTS NUMBER

Part number 1	Part number 2	Rated voltage [V]	Temperature characteristics		Capacitance [F]	Capacitance tolerance [%]	tan δ [%]	HTLT	Thickness*3 [mm]	Soldering R:Reflow W:Wave	
								Rated voltage x %			
LMK316 BJ475□D-T		10	B	X5R	4.7 μ	±10, ±20	5	200	0.85±0.10	R	
LMK316 BJ106□D-T			B	X5R	10 μ	±10, ±20	10	200	0.85±0.10	R	
LMK316ABJ226MD-T	LMK316 BJ226MD-T				X5R	22 μ	±20	10	150	0.85±0.10	R
JMK316 BJ106□D-T		6.3	B	X5R	10 μ	±10, ±20	10	200	0.85±0.10	R	
JMK316ABJ226MD-T	JMK316 BJ226MD-T				X5R	22 μ	±20	10	150	0.85±0.10	R
JMK316ABJ476MD-T	JMK316 BJ476MD-T				X5R	47 μ	±20	10	150	0.85±0.10	R

[Temperature Characteristic C7 : X7S] 1.6mm thickness(L)

Part number 1	Part number 2	Rated voltage [V]	Temperature characteristics		Capacitance [F]	Capacitance tolerance [%]	tan δ [%]	HTLT	Thickness*3 [mm]	Soldering R:Reflow W:Wave
								Rated voltage x %		
AMK316AC7476ML-T		4		X7S	47 μ	±20	10	150	1.6±0.20	R

[Temperature Characteristic C6 : X6S] 1.6mm thickness(L)

Part number 1	Part number 2	Rated voltage [V]	Temperature characteristics		Capacitance [F]	Capacitance tolerance [%]	tan δ [%]	HTLT	Thickness*3 [mm]	Soldering R:Reflow W:Wave
								Rated voltage x %		
EMK316BC6226ML-T		16		X6S	22 μ	±20	10	150	1.6±0.30	R
JMK316AC6476ML-T		6.3		X6S	47 μ	±20	10	150	1.6±0.20	R
AMK316AC6476ML-T		4		X6S	47 μ	±20	10	200	1.6±0.20	R
AMK316AC6107ML-T					X6S	100 μ	±20	10	150	1.6±0.20

[Temperature Characteristic B7 : X7R] 1.6mm thickness(L)

Part number 1	Part number 2	Rated voltage [V]	Temperature characteristics		Capacitance [F]	Capacitance tolerance [%]	tan δ [%]	HTLT	Thickness*3 [mm]	Soldering R:Reflow W:Wave	
								Rated voltage x %			
UMK316 B7224□L-T		50		X7R	0.22 μ	±10, ±20	2.5	200	1.6±0.20	R/W	
UMK316 B7474□L-T				X7R	0.47 μ	±10, ±20	3.5	200	1.6±0.20	R/W	
UMK316 B7105□L-T				X7R	1 μ	±10, ±20	3.5	200	1.6±0.20	R	
UMK316 B7225□L-T				X7R	2.2 μ	±10, ±20	10	150	1.6±0.20	R	
UMK316AB7475□L-T	UMK316 B7475□L-T			X7R	4.7 μ	±10, ±20	10	150	1.6±0.20	R	
GMK316AB7106□L-TR		35		X7R	10 μ	±10, ±20	10	150	1.6±0.20	R	
TMK316 B7105□L-T		25		X7R	1 μ	±10, ±20	3.5	200	1.6±0.20	R/W	
TMK316 B7225□L-T					X7R	2.2 μ	±10, ±20	3.5	200	1.6±0.20	R
TMK316AB7475□L-T	TMK316 B7475□L-T				X7R	4.7 μ	±10, ±20	10	200	1.6±0.20	R
TMK316AB7106□L-T	TMK316 B7106□L-TD			X7R	10 μ	±10, ±20	10	150	1.6±0.20	R	
EMK316 B7225□L-T		16		X7R	2.2 μ	±10, ±20	3.5	200	1.6±0.20	R/W	
EMK316 B7475□L-T					X7R	4.7 μ	±10, ±20	5	200	1.6±0.20	R
EMK316AB7106□L-T	EMK316 B7106□L-TD				X7R	10 μ	±10, ±20	10	200	1.6±0.20	R
EMK316BB7226ML-T				X7R	22 μ	±20	10	150	1.6±0.30	R	
LMK316 B7225□L-T		10		X7R	2.2 μ	±10, ±20	3.5	200	1.6±0.20	R/W	
LMK316 B7475□L-T					X7R	4.7 μ	±10, ±20	5	200	1.6±0.20	R
LMK316AB7106□L-T	LMK316 B7106□L-TD				X7R	10 μ	±10, ±20	10	200	1.6±0.20	R
LMK316AB7226□L-TR	LMK316 B7226□L-TD			X7R	22 μ	±10, ±20	10	150	1.6±0.20	R	
JMK316 B7106□L-T		6.3		X7R	10 μ	±10, ±20	5	200	1.6±0.20	R	

[Temperature Characteristic B7 : X7R] 0.85mm thickness(D)

Part number 1	Part number 2	Rated voltage [V]	Temperature characteristics		Capacitance [F]	Capacitance tolerance [%]	tan δ [%]	HTLT	Thickness*3 [mm]	Soldering R:Reflow W:Wave
								Rated voltage x %		
UMK316 B7225□D-T		50		X7R	2.2 μ	±10, ±20	10	150	0.85±0.10	R
TMK316AB7475□D-T		25		X7R	4.7 μ	±10, ±20	10	150	0.85±0.10	R
LMK316AB7106MD-T		10		X7R	10 μ	±20	10	150	0.85±0.10	R

[Temperature Characteristic F : F/Y5V] 1.6mm thickness(L)

Part number 1	Part number 2	Rated voltage [V]	Temperature characteristics		Capacitance [F]	Capacitance tolerance [%]	tan δ [%]	HTLT	Thickness*3 [mm]	Soldering R:Reflow W:Wave
								Rated voltage x %		
GMK316 F1062L-T		35	F	Y5V	10 μ	+80/-20	9	200	1.6±0.20	R
TMK316 F1062L-T		25	F	Y5V	10 μ	+80/-20	9	200	1.6±0.20	R
EMK316 F1062L-T		16	F	Y5V	10 μ	+80/-20	9	200	1.6±0.20	R
LMK316 F2262L-T		10	F	Y5V	22 μ	+80/-20	16	200	1.6±0.20	R

[Temperature Characteristic F : F/Y5V] 1.25mm thickness(G)

Part number 1	Part number 2	Rated voltage [V]	Temperature characteristics		Capacitance [F]	Capacitance tolerance [%]	tan δ [%]	HTLT	Thickness*3 [mm]	Soldering R:Reflow W:Wave
								Rated voltage x %		
UMK316 F2252G-T		50	F	Y5V	2.2 μ	+80/-20	7	200	1.25±0.10	R/W
GMK316 F4752G-T		35	F	Y5V	4.7 μ	+80/-20	7	200	1.25±0.10	R

[Temperature Characteristic F : F/Y5V] 0.85mm thickness(D)

Part number 1	Part number 2	Rated voltage [V]	Temperature characteristics		Capacitance [F]	Capacitance tolerance [%]	tan δ [%]	HTLT	Thickness*3 [mm]	Soldering R:Reflow W:Wave
								Rated voltage x %		
LMK316 F4752D-T		10	F	Y5V	4.7 μ	+80/-20	9	200	0.85±0.10	R
JMK316 F1062D-T		6.3	F	Y5V	10 μ	+80/-20	16	200	0.85±0.10	R

● 325TYPE

[Temperature Characteristic BJ : B/X5R] 2.5mm thickness(M)

Part number 1	Part number 2	Rated voltage [V]	Temperature characteristics		Capacitance [F]	Capacitance tolerance [%]	tan δ [%]	HTLT	Thickness*3 [mm]	Soldering R:Reflow W:Wave	
								Rated voltage x %			
UMK325 BJ475□M-P		50		X5R	4.7 μ	±10, ±20	5	150	2.5±0.20	R	
UMK325 BJ106□M-P					X5R	10 μ	±10, ±20	5	150	2.5±0.20	R
GMK325 BJ226MM-P		35		X5R	22 μ	±20	10	150	2.5±0.20	R	
TMK325 BJ106□M-P		25	B	X5R ^{†1}	10 μ	±10, ±20	3.5	150	2.5±0.20	R	
TMK325 BJ226□M-P					X5R	22 μ	±10, ±20	5	150	2.5±0.20	R
TMK325ABJ476MM-P					X5R	47 μ	±20	10	150	2.5±0.30	R
EMK325 BJ226□M-P		16	B	X5R	22 μ	±10, ±20	5	150	2.5±0.20	R	
EMK325 BJ476MM-P					X5R	47 μ	±20	10	150	2.5±0.20	R
EMK325ABJ107MM-P					X5R	100 μ	±20	10	150	2.5±0.30	R

▶ This catalog contains the typical specification only due to the limitation of space. When you consider the purchase of our products, please check our specification. For details of each product (characteristics graph, reliability information, precautions for use, and so on), see our Web site (<http://www.ty-top.com/>).

■ PARTS NUMBER

Part number 1	Part number 2	Rated voltage [V]	Temperature characteristics		Capacitance [F]	Capacitance tolerance [%]	tan δ [%]	HTLT	Thickness ^{*3} [mm]	Soldering R:Reflow W:Wave
								Rated voltage x %		
LMK325 BJ226□M-P		10	B	X5R	22 μ	±10, ±20	5	200	2.5±0.20	R
LMK325 BJ476MM-P					47 μ	±20	10	150	2.5±0.20	R
LMK325ABJ107MM-P	LMK325 BJ107MM-P				100 μ	±20	10	150	2.5±0.30	R
JMK325 BJ476MM-P		6.3	B	X5R	47 μ	±20	10	150	2.5±0.20	R
JMK325ABJ107MM-P	JMK325 BJ107MM-P				100 μ	±20	10	150	2.5±0.30	R
JMK325ABJ157MM-P					150 μ	±20	10	150	2.5±0.30	R
JMK325ABJ227MM-P		4	B	X5R	220 μ	±20	10	150	2.5±0.30	R
AMK325ABJ157MM-P					150 μ	±20	10	150	2.5±0.30	R
AMK325ABJ227MM-P					220 μ	±20	10	150	2.5±0.30	R
AMK325ABJ337MM-P				X5R	330 μ	±20	10	150	2.5±0.30	R

【Temperature Characteristic BJ : B/X5R】 1.9mm thickness (Y,N)

Part number 1	Part number 2	Rated voltage [V]	Temperature characteristics		Capacitance [F]	Capacitance tolerance [%]	tan δ [%]	HTLT	Thickness ^{*3} [mm]	Soldering R:Reflow W:Wave
								Rated voltage x %		
UMK325 BJ475□N-T		50	B	X5R	4.7 μ	±10, ±20	10	150	1.9±0.20	R
GMK325 BJ225□N-T		35			2.2 μ	±10, ±20	3.5	200	1.9±0.20	R
GMK325 BJ475□N-T				X5R	4.7 μ	±10, ±20	10	150	1.9±0.20	R
GMK325 BJ106□N-T		25	B	X5R ^{*1}	10 μ	±10, ±20	5	150	1.9±0.20	R
TMK325 BJ335MN-T					3.3 μ	±20	3.5	200	1.9±0.20	R
TMK325 BJ475□N-T					4.7 μ	±10, ±20	3.5	200	1.9±0.20	R
TMK325 BJ106□N-T		16	B	X5R ^{*1}	10 μ	±10, ±20	5	200	1.9±0.20	R
EMK325 BJ475□N-T					4.7 μ	±10, ±20	3.5	200	1.9±0.20	R
EMK325 BJ106□N-T					10 μ	±10, ±20	3.5	200	1.9±0.20	R
EMK325 BJ476MY-T		10	B	X5R	47 μ	±20	10	150	1.9+0.1/-0.2	R
LMK325 BJ226MY-T					22 μ	±20	5	150	1.9+0.1/-0.2	R
LMK325 BJ106□N-T					10 μ	±10, ±20	3.5	200	1.9±0.20	R
JMK325 BJ226MY-T		6.3	B	X5R	22 μ	±20	5	200	1.9+0.1/-0.2	R
JMK325 BJ107MY-T					100 μ	±20	10	150	1.9+0.1/-0.2	R
JMK325 BJ476MN-T					47 μ	±20	10	150	1.9±0.20	R

【Temperature Characteristic BJ : B/X5R】 0.85mm thickness (D)

Part number 1	Part number 2	Rated voltage [V]	Temperature characteristics		Capacitance [F]	Capacitance tolerance [%]	tan δ [%]	HTLT	Thickness ^{*3} [mm]	Soldering R:Reflow W:Wave
								Rated voltage x %		
TMK325 BJ106□D-T		25	B	X5R	10 μ	±10, ±20	5	150	0.85±0.10	R
EMK325 BJ106□D-T		16			X5R	10 μ	±10, ±20	5	150	0.85±0.10
EMK325 BJ226MD-T				B	X5R	22 μ	±20	10	150	0.85±0.10
LMK325 BJ335□D-T		10	B	X5R	3.3 μ	±10, ±20	3.5	200	0.85±0.10	R
LMK325 BJ475□D-T					4.7 μ	±10, ±20	5	200	0.85±0.10	R
LMK325 BJ106□D-T					10 μ	±10, ±20	5	150	0.85±0.10	R

【Temperature Characteristic C7 : X7S】 2.5mm thickness (M)

Part number 1	Part number 2	Rated voltage [V]	Temperature characteristics		Capacitance [F]	Capacitance tolerance [%]	tan δ [%]	HTLT	Thickness ^{*3} [mm]	Soldering R:Reflow W:Wave
								Rated voltage x %		
JMK325AC7107MM-P		6.3		X7S	100 μ	±20	10	150	2.5±0.30	R

【Temperature Characteristic C6 : X6S】 2.5mm thickness (M)

Part number 1	Part number 2	Rated voltage [V]	Temperature characteristics		Capacitance [F]	Capacitance tolerance [%]	tan δ [%]	HTLT	Thickness ^{*3} [mm]	Soldering R:Reflow W:Wave
								Rated voltage x %		
EMK325AC6476MM-P		16		X6S	47 μ	±20	10	150	2.5±0.30	R
LMK325AC6107MM-P		10		X6S	100 μ	±20	10	150	2.5±0.30	R
JMK325AC6107MM-P		6.3		X6S	100 μ	±20	10	150	2.5±0.30	R
AMK325AC6157MM-P		4		X6S	150 μ	±20	10	150	2.5±0.30	R
AMK325AC6227MM-P			X6S	220 μ	±20	10	150	2.5±0.30	R	
PMK325AC6337MM-P		2.5		X6S	330 μ	±20	10	150	2.5±0.30	R

【Temperature Characteristic B7 : X7R】 2.5mm thickness (M)

Part number 1	Part number 2	Rated voltage [V]	Temperature characteristics		Capacitance [F]	Capacitance tolerance [%]	tan δ [%]	HTLT	Thickness ^{*3} [mm]	Soldering R:Reflow W:Wave
								Rated voltage x %		
UMK325 B7475□M-P		50		X7R	4.7 μ	±10, ±20	5	150	2.5±0.20	R
UMK325AB7106□M-P					10 μ	±10, ±20	10	150	2.5±0.30	R
TMK325AB7106□M-P					10 μ	±10, ±20	10	150	2.5±0.30	R
TMK325 B7226□M-PR		16		X7R	22 μ	±10, ±20	10	150	2.5±0.20	R
EMK325 B7226□M-PR					22 μ	±10, ±20	10	150	2.5±0.20	R
LMK325 B7476□M-PR					10	X7R	47 μ	±10, ±20	10	150
JMK325 B7476□M-PR		6.3		X7R	47 μ	±10, ±20	10	200	2.5±0.20	R

【Temperature Characteristic B7 : X7R】 1.9mm thickness (N)

Part number 1	Part number 2	Rated voltage [V]	Temperature characteristics		Capacitance [F]	Capacitance tolerance [%]	tan δ [%]	HTLT	Thickness ^{*3} [mm]	Soldering R:Reflow W:Wave
								Rated voltage x %		
UMK325 B7475□N-TR		50		X7R	4.7 μ	±10, ±20	10	150	1.9±0.20	R
TMK325 B7335□N-T		25		X7R	3.3 μ	±10, ±20	3.5	200	1.9±0.20	R
TMK325 B7475□N-T					4.7 μ	±10, ±20	3.5	150	1.9±0.20	R
TMK325 B7106□N-TR					10 μ	±10, ±20	10	150	1.9±0.20	R
EMK325 B7475□N-T		16		X7R	4.7 μ	±10, ±20	3.5	200	1.9±0.20	R
EMK325 B7106□N-T					10 μ	±10, ±20	3.5	150	1.9±0.20	R
LMK325 B7106□N-T					10 μ	±10, ±20	3.5	200	1.9±0.20	R

【Temperature Characteristic F : F/Y5V】 1.9mm thickness (N)

Part number 1	Part number 2	Rated voltage [V]	Temperature characteristics		Capacitance [F]	Capacitance tolerance [%]	tan δ [%]	HTLT	Thickness ^{*3} [mm]	Soldering R:Reflow W:Wave
								Rated voltage x %		
EMK325 F226ZN-T		16	F	Y5V	22 μ	+80/-20	16	200	1.9±0.20	R
LMK325 F226ZN-T		10	F	Y5V	22 μ	+80/-20	16	200	1.9±0.20	R
JMK325 F476ZN-T		6.3	F	Y5V	47 μ	+80/-20	16	200	1.9±0.20	R

▶ This catalog contains the typical specification only due to the limitation of space. When you consider the purchase of our products, please check our specification. For details of each product (characteristics graph, reliability information, precautions for use, and so on), see our Web site (<http://www.ty-top.com/>).

■ PARTS NUMBER

● 432TYPE

[Temperature Characteristic B7 : X7R] 2.5mm thickness(M)

Part number 1	Part number 2	Rated voltage [V]	Temperature characteristics	Capacitance [F]	Capacitance tolerance [%]	tan δ [%]	HTLT		Soldering R:Reflow W:Wave
							Rated voltage x %	Thickness*3 [mm]	
AMK432 BJ477MM-T		4	X5R	470 μ	±20	10	150	2.5±0.20	R

[Temperature Characteristic C6 : X6S] 2.5mm thickness(M)

Part number 1	Part number 2	Rated voltage [V]	Temperature characteristics	Capacitance [F]	Capacitance tolerance [%]	tan δ [%]	HTLT		Soldering R:Reflow W:Wave
							Rated voltage x %	Thickness*3 [mm]	
PMK432 C6477MM-T		2.5	X6S	470 μ	±20	10	150	2.5±0.20	R

Multilayer Ceramic Capacitors(Temperature compensating type)

● 021TYPE

[Temperature Characteristic CΔ : CΔ/C0Δ] 0.125mm thickness(K)

Part number 1	Part number 2	Rated voltage [V]	Temperature characteristics	Capacitance [F]	Capacitance tolerance [%]	Q (at 1MHz) min	HTLT		Soldering R:Reflow W:Wave
							Rated voltage x %	Thickness*3 [mm]	
TMK021 CK0R2□K-W		25	CK COK	0.2 p	±0.1pF, ±0.25pF	404	200	0.125±0.013	R
TMK021 CK0R3□K-W			CK COK	0.3 p	±0.1pF, ±0.25pF	406	200	0.125±0.013	R
TMK021 CK0R4□K-W			CK COK	0.4 p	±0.1pF, ±0.25pF	408	200	0.125±0.013	R
TMK021 CK0R5□K-W			CK COK	0.5 p	±0.1pF, ±0.25pF	410	200	0.125±0.013	R
TMK021 CK0R6□K-W			CK COK	0.6 p	±0.1pF, ±0.25pF	412	200	0.125±0.013	R
TMK021 CK0R7□K-W			CK COK	0.7 p	±0.1pF, ±0.25pF	414	200	0.125±0.013	R
TMK021 CKR75□K-W			CK COK	0.75 p	±0.1pF, ±0.25pF	415	200	0.125±0.013	R
TMK021 CK0R8□K-W			CK COK	0.8 p	±0.1pF, ±0.25pF	416	200	0.125±0.013	R
TMK021 CK0R9□K-W			CK COK	0.9 p	±0.1pF, ±0.25pF	418	200	0.125±0.013	R
TMK021 CK010□K-W			CK COK	1 p	±0.1pF, ±0.25pF	420	200	0.125±0.013	R
TMK021 CK1R1□K-W			CK COK	1.1 p	±0.1pF, ±0.25pF	422	200	0.125±0.013	R
TMK021 CK1R2□K-W			CK COK	1.2 p	±0.1pF, ±0.25pF	424	200	0.125±0.013	R
TMK021 CK1R3□K-W			CK COK	1.3 p	±0.1pF, ±0.25pF	426	200	0.125±0.013	R
TMK021 CK1R4□K-W			CK COK	1.4 p	±0.1pF, ±0.25pF	428	200	0.125±0.013	R
TMK021 CK1R5□K-W			CK COK	1.5 p	±0.1pF, ±0.25pF	430	200	0.125±0.013	R
TMK021 CK1R6□K-W			CK COK	1.6 p	±0.1pF, ±0.25pF	432	200	0.125±0.013	R
TMK021 CK1R7□K-W			CK COK	1.7 p	±0.1pF, ±0.25pF	434	200	0.125±0.013	R
TMK021 CK1R8□K-W			CK COK	1.8 p	±0.1pF, ±0.25pF	436	200	0.125±0.013	R
TMK021 CK1R9□K-W			CK COK	1.9 p	±0.1pF, ±0.25pF	438	200	0.125±0.013	R
TMK021 CK020□K-W			CK COK	2 p	±0.1pF, ±0.25pF	440	200	0.125±0.013	R
TMK021 CK2R1□K-W			CK COK	2.1 p	±0.1pF, ±0.25pF	442	200	0.125±0.013	R
TMK021 CK2R2□K-W			CK COK	2.2 p	±0.1pF, ±0.25pF	444	200	0.125±0.013	R
TMK021 CK2R3□K-W			CK COK	2.3 p	±0.1pF, ±0.25pF	446	200	0.125±0.013	R
TMK021 CK2R4□K-W			CK COK	2.4 p	±0.1pF, ±0.25pF	448	200	0.125±0.013	R
TMK021 CK2R5□K-W			CK COK	2.5 p	±0.1pF, ±0.25pF	450	200	0.125±0.013	R
TMK021 CK2R6□K-W			CK COK	2.6 p	±0.1pF, ±0.25pF	452	200	0.125±0.013	R
TMK021 CK2R7□K-W			CK COK	2.7 p	±0.1pF, ±0.25pF	454	200	0.125±0.013	R
TMK021 CK2R8□K-W			CK COK	2.8 p	±0.1pF, ±0.25pF	456	200	0.125±0.013	R
TMK021 CK2R9□K-W			CK COK	2.9 p	±0.1pF, ±0.25pF	458	200	0.125±0.013	R
TMK021 CJ030□K-W			CJ COJ	3 p	±0.1pF, ±0.25pF	460	200	0.125±0.013	R
TMK021 CJ3R1□K-W			CJ COJ	3.1 p	±0.1pF, ±0.25pF	462	200	0.125±0.013	R
TMK021 CJ3R2□K-W			CJ COJ	3.2 p	±0.1pF, ±0.25pF	464	200	0.125±0.013	R
TMK021 CJ3R3□K-W			CJ COJ	3.3 p	±0.1pF, ±0.25pF	466	200	0.125±0.013	R
TMK021 CJ3R4□K-W			CJ COJ	3.4 p	±0.1pF, ±0.25pF	468	200	0.125±0.013	R
TMK021 CJ3R5□K-W			CJ COJ	3.5 p	±0.1pF, ±0.25pF	470	200	0.125±0.013	R
TMK021 CJ3R6□K-W			CJ COJ	3.6 p	±0.1pF, ±0.25pF	472	200	0.125±0.013	R
TMK021 CJ3R7□K-W			CJ COJ	3.7 p	±0.1pF, ±0.25pF	474	200	0.125±0.013	R
TMK021 CJ3R8□K-W			CJ COJ	3.8 p	±0.1pF, ±0.25pF	476	200	0.125±0.013	R
TMK021 CJ3R9□K-W			CJ COJ	3.9 p	±0.1pF, ±0.25pF	478	200	0.125±0.013	R
TMK021 CH040□K-W			CH COH	4 p	±0.1pF, ±0.25pF	480	200	0.125±0.013	R
TMK021 CH4R1□K-W			CH COH	4.1 p	±0.1pF, ±0.25pF	482	200	0.125±0.013	R
TMK021 CH4R2□K-W			CH COH	4.2 p	±0.1pF, ±0.25pF	484	200	0.125±0.013	R
TMK021 CH4R3□K-W			CH COH	4.3 p	±0.1pF, ±0.25pF	486	200	0.125±0.013	R
TMK021 CH4R4□K-W			CH COH	4.4 p	±0.1pF, ±0.25pF	488	200	0.125±0.013	R
TMK021 CH4R5□K-W			CH COH	4.5 p	±0.1pF, ±0.25pF	490	200	0.125±0.013	R
TMK021 CH4R6□K-W			CH COH	4.6 p	±0.1pF, ±0.25pF	492	200	0.125±0.013	R
TMK021 CH4R7□K-W			CH COH	4.7 p	±0.1pF, ±0.25pF	494	200	0.125±0.013	R
TMK021 CH4R8□K-W			CH COH	4.8 p	±0.1pF, ±0.25pF	496	200	0.125±0.013	R
TMK021 CH4R9□K-W			CH COH	4.9 p	±0.1pF, ±0.25pF	498	200	0.125±0.013	R
TMK021 CH050□K-W			CH COH	5 p	±0.1pF, ±0.25pF	500	200	0.125±0.013	R
TMK021 CH5R1□K-W			CH COH	5.1 p	±0.25pF, ±0.5pF	502	200	0.125±0.013	R
TMK021 CH5R2□K-W			CH COH	5.2 p	±0.25pF, ±0.5pF	504	200	0.125±0.013	R
TMK021 CH5R3□K-W			CH COH	5.3 p	±0.25pF, ±0.5pF	506	200	0.125±0.013	R
TMK021 CH5R4□K-W			CH COH	5.4 p	±0.25pF, ±0.5pF	508	200	0.125±0.013	R
TMK021 CH5R5□K-W			CH COH	5.5 p	±0.25pF, ±0.5pF	510	200	0.125±0.013	R
TMK021 CH5R6□K-W			CH COH	5.6 p	±0.25pF, ±0.5pF	512	200	0.125±0.013	R
TMK021 CH5R7□K-W			CH COH	5.7 p	±0.25pF, ±0.5pF	514	200	0.125±0.013	R
TMK021 CH5R8□K-W			CH COH	5.8 p	±0.25pF, ±0.5pF	516	200	0.125±0.013	R
TMK021 CH5R9□K-W			CH COH	5.9 p	±0.25pF, ±0.5pF	518	200	0.125±0.013	R
TMK021 CH060□K-W			CH COH	6 p	±0.25pF, ±0.5pF	520	200	0.125±0.013	R
TMK021 CH6R1□K-W			CH COH	6.1 p	±0.25pF, ±0.5pF	522	200	0.125±0.013	R
TMK021 CH6R2□K-W			CH COH	6.2 p	±0.25pF, ±0.5pF	524	200	0.125±0.013	R
TMK021 CH6R3□K-W			CH COH	6.3 p	±0.25pF, ±0.5pF	526	200	0.125±0.013	R
TMK021 CH6R4□K-W			CH COH	6.4 p	±0.25pF, ±0.5pF	528	200	0.125±0.013	R
TMK021 CH6R5□K-W			CH COH	6.5 p	±0.25pF, ±0.5pF	530	200	0.125±0.013	R
TMK021 CH6R6□K-W			CH COH	6.6 p	±0.25pF, ±0.5pF	532	200	0.125±0.013	R
TMK021 CH6R7□K-W			CH COH	6.7 p	±0.25pF, ±0.5pF	534	200	0.125±0.013	R
TMK021 CH6R8□K-W			CH COH	6.8 p	±0.25pF, ±0.5pF	536	200	0.125±0.013	R
TMK021 CH6R9□K-W			CH COH	6.9 p	±0.25pF, ±0.5pF	538	200	0.125±0.013	R
TMK021 CH070□K-W			CH COH	7 p	±0.25pF, ±0.5pF	540	200	0.125±0.013	R
TMK021 CH7R1□K-W		CH COH	7.1 p	±0.25pF, ±0.5pF	542	200	0.125±0.013	R	
TMK021 CH7R2□K-W		CH COH	7.2 p	±0.25pF, ±0.5pF	544	200	0.125±0.013	R	
TMK021 CH7R3□K-W		CH COH	7.3 p	±0.25pF, ±0.5pF	546	200	0.125±0.013	R	

▶ This catalog contains the typical specification only due to the limitation of space. When you consider the purchase of our products, please check our specification. For details of each product (characteristics graph, reliability information, precautions for use, and so on), see our Web site (<http://www.ty-top.com/>).

■ PARTS NUMBER

Part number 1	Part number 2	Rated voltage [V]	Temperature characteristics	Capacitance [F]	Capacitance tolerance [%]	Q (at 1MHz) min	HTLT		Thickness*3 [mm]	Soldering R:Reflow W:Wave	
							Rated voltage x %				
TMK021 CH7R4	[K-W]	25	CH C0H	7.4 p	±0.25pF, ±0.5pF	548	200		0.125±0.013	R	
TMK021 CH7R5	[K-W]		CH C0H	7.5 p	±0.25pF, ±0.5pF	550	200		0.125±0.013	R	
TMK021 CH7R6	[K-W]		CH C0H	7.6 p	±0.25pF, ±0.5pF	552	200		0.125±0.013	R	
TMK021 CH7R7	[K-W]		CH C0H	7.7 p	±0.25pF, ±0.5pF	554	200		0.125±0.013	R	
TMK021 CH7R8	[K-W]		CH C0H	7.8 p	±0.25pF, ±0.5pF	556	200		0.125±0.013	R	
TMK021 CH7R9	[K-W]		CH C0H	7.9 p	±0.25pF, ±0.5pF	558	200		0.125±0.013	R	
TMK021 CH080	[K-W]		CH C0H	8 p	±0.25pF, ±0.5pF	560	200		0.125±0.013	R	
TMK021 CH8R1	[K-W]		CH C0H	8.1 p	±0.25pF, ±0.5pF	562	200		0.125±0.013	R	
TMK021 CH8R2	[K-W]		CH C0H	8.2 p	±0.25pF, ±0.5pF	564	200		0.125±0.013	R	
TMK021 CH8R3	[K-W]		CH C0H	8.3 p	±0.25pF, ±0.5pF	566	200		0.125±0.013	R	
TMK021 CH8R4	[K-W]		CH C0H	8.4 p	±0.25pF, ±0.5pF	568	200		0.125±0.013	R	
TMK021 CH8R5	[K-W]		CH C0H	8.5 p	±0.25pF, ±0.5pF	570	200		0.125±0.013	R	
TMK021 CH8R6	[K-W]		CH C0H	8.6 p	±0.25pF, ±0.5pF	572	200		0.125±0.013	R	
TMK021 CH8R7	[K-W]		CH C0H	8.7 p	±0.25pF, ±0.5pF	574	200		0.125±0.013	R	
TMK021 CH8R8	[K-W]		CH C0H	8.8 p	±0.25pF, ±0.5pF	576	200		0.125±0.013	R	
TMK021 CH8R9	[K-W]		CH C0H	8.9 p	±0.25pF, ±0.5pF	578	200		0.125±0.013	R	
TMK021 CH090	[K-W]		CH C0H	9 p	±0.25pF, ±0.5pF	580	200		0.125±0.013	R	
TMK021 CH9R1	[K-W]		CH C0H	9.1 p	±0.25pF, ±0.5pF	582	200		0.125±0.013	R	
TMK021 CH9R2	[K-W]		CH C0H	9.2 p	±0.25pF, ±0.5pF	584	200		0.125±0.013	R	
TMK021 CH9R3	[K-W]		CH C0H	9.3 p	±0.25pF, ±0.5pF	586	200		0.125±0.013	R	
TMK021 CH9R4	[K-W]		CH C0H	9.4 p	±0.25pF, ±0.5pF	588	200		0.125±0.013	R	
TMK021 CH9R5	[K-W]		CH C0H	9.5 p	±0.25pF, ±0.5pF	590	200		0.125±0.013	R	
TMK021 CH9R6	[K-W]		CH C0H	9.6 p	±0.25pF, ±0.5pF	592	200		0.125±0.013	R	
TMK021 CH9R7	[K-W]		CH C0H	9.7 p	±0.25pF, ±0.5pF	594	200		0.125±0.013	R	
TMK021 CH9R8	[K-W]		CH C0H	9.8 p	±0.25pF, ±0.5pF	596	200		0.125±0.013	R	
TMK021 CH9R9	[K-W]		CH C0H	9.9 p	±0.25pF, ±0.5pF	598	200		0.125±0.013	R	
TMK021 CH100DK	[K-W]		CH C0H	10 p		±0.5pF	600	200		0.125±0.013	R

【Temperature Characteristic CG : CG/C0G】 0.125mm thickness (K)

Part number 1	Part number 2	Rated voltage [V]	Temperature characteristics	Capacitance [F]	Capacitance tolerance [%]	Q (at 1MHz) min	HTLT		Thickness*3 [mm]	Soldering R:Reflow W:Wave
							Rated voltage x %			
TMK021 CG0R2	[K-W]	25	CG C0G	0.2 p	±0.1pF, ±0.25pF	404	200		0.125±0.013	R
TMK021 CG0R3	[K-W]		CG C0G	0.3 p	±0.1pF, ±0.25pF	406	200		0.125±0.013	R
TMK021 CG0R4	[K-W]		CG C0G	0.4 p	±0.1pF, ±0.25pF	408	200		0.125±0.013	R
TMK021 CG0R5	[K-W]		CG C0G	0.5 p	±0.1pF, ±0.25pF	410	200		0.125±0.013	R
TMK021 CG0R6	[K-W]		CG C0G	0.6 p	±0.1pF, ±0.25pF	412	200		0.125±0.013	R
TMK021 CG0R7	[K-W]		CG C0G	0.7 p	±0.1pF, ±0.25pF	414	200		0.125±0.013	R
TMK021 CGR75	[K-W]		CG C0G	0.75 p	±0.1pF, ±0.25pF	415	200		0.125±0.013	R
TMK021 CG0R8	[K-W]		CG C0G	0.8 p	±0.1pF, ±0.25pF	416	200		0.125±0.013	R
TMK021 CG0R9	[K-W]		CG C0G	0.9 p	±0.1pF, ±0.25pF	418	200		0.125±0.013	R
TMK021 CG010	[K-W]		CG C0G	1 p	±0.1pF, ±0.25pF	420	200		0.125±0.013	R
TMK021 CG1R1	[K-W]		CG C0G	1.1 p	±0.1pF, ±0.25pF	422	200		0.125±0.013	R
TMK021 CG1R2	[K-W]		CG C0G	1.2 p	±0.1pF, ±0.25pF	424	200		0.125±0.013	R
TMK021 CG1R3	[K-W]		CG C0G	1.3 p	±0.1pF, ±0.25pF	426	200		0.125±0.013	R
TMK021 CG1R4	[K-W]		CG C0G	1.4 p	±0.1pF, ±0.25pF	428	200		0.125±0.013	R
TMK021 CG1R5	[K-W]		CG C0G	1.5 p	±0.1pF, ±0.25pF	430	200		0.125±0.013	R
TMK021 CG1R6	[K-W]		CG C0G	1.6 p	±0.1pF, ±0.25pF	432	200		0.125±0.013	R
TMK021 CG1R7	[K-W]		CG C0G	1.7 p	±0.1pF, ±0.25pF	434	200		0.125±0.013	R
TMK021 CG1R8	[K-W]		CG C0G	1.8 p	±0.1pF, ±0.25pF	436	200		0.125±0.013	R
TMK021 CG1R9	[K-W]		CG C0G	1.9 p	±0.1pF, ±0.25pF	438	200		0.125±0.013	R
TMK021 CG020	[K-W]		CG C0G	2 p	±0.1pF, ±0.25pF	440	200		0.125±0.013	R
TMK021 CG2R1	[K-W]		CG C0G	2.1 p	±0.1pF, ±0.25pF	442	200		0.125±0.013	R
TMK021 CG2R2	[K-W]		CG C0G	2.2 p	±0.1pF, ±0.25pF	444	200		0.125±0.013	R
TMK021 CG2R3	[K-W]		CG C0G	2.3 p	±0.1pF, ±0.25pF	446	200		0.125±0.013	R
TMK021 CG2R4	[K-W]		CG C0G	2.4 p	±0.1pF, ±0.25pF	448	200		0.125±0.013	R
TMK021 CG2R5	[K-W]		CG C0G	2.5 p	±0.1pF, ±0.25pF	450	200		0.125±0.013	R
TMK021 CG2R6	[K-W]		CG C0G	2.6 p	±0.1pF, ±0.25pF	452	200		0.125±0.013	R
TMK021 CG2R7	[K-W]		CG C0G	2.7 p	±0.1pF, ±0.25pF	454	200		0.125±0.013	R
TMK021 CG2R8	[K-W]		CG C0G	2.8 p	±0.1pF, ±0.25pF	456	200		0.125±0.013	R
TMK021 CG2R9	[K-W]		CG C0G	2.9 p	±0.1pF, ±0.25pF	458	200		0.125±0.013	R
TMK021 CG030	[K-W]		CG C0G	3 p	±0.1pF, ±0.25pF	460	200		0.125±0.013	R
TMK021 CG3R1	[K-W]		CG C0G	3.1 p	±0.1pF, ±0.25pF	462	200		0.125±0.013	R
TMK021 CG3R2	[K-W]		CG C0G	3.2 p	±0.1pF, ±0.25pF	464	200		0.125±0.013	R
TMK021 CG3R3	[K-W]		CG C0G	3.3 p	±0.1pF, ±0.25pF	466	200		0.125±0.013	R
TMK021 CG3R4	[K-W]		CG C0G	3.4 p	±0.1pF, ±0.25pF	468	200		0.125±0.013	R
TMK021 CG3R5	[K-W]		CG C0G	3.5 p	±0.1pF, ±0.25pF	470	200		0.125±0.013	R
TMK021 CG3R6	[K-W]		CG C0G	3.6 p	±0.1pF, ±0.25pF	472	200		0.125±0.013	R
TMK021 CG3R7	[K-W]		CG C0G	3.7 p	±0.1pF, ±0.25pF	474	200		0.125±0.013	R
TMK021 CG3R8	[K-W]		CG C0G	3.8 p	±0.1pF, ±0.25pF	476	200		0.125±0.013	R
TMK021 CG3R9	[K-W]		CG C0G	3.9 p	±0.1pF, ±0.25pF	478	200		0.125±0.013	R
TMK021 CG040	[K-W]		CG C0G	4 p	±0.1pF, ±0.25pF	480	200		0.125±0.013	R
TMK021 CG4R1	[K-W]		CG C0G	4.1 p	±0.1pF, ±0.25pF	482	200		0.125±0.013	R
TMK021 CG4R2	[K-W]		CG C0G	4.2 p	±0.1pF, ±0.25pF	484	200		0.125±0.013	R
TMK021 CG4R3	[K-W]		CG C0G	4.3 p	±0.1pF, ±0.25pF	486	200		0.125±0.013	R
TMK021 CG4R4	[K-W]		CG C0G	4.4 p	±0.1pF, ±0.25pF	488	200		0.125±0.013	R
TMK021 CG4R5	[K-W]		CG C0G	4.5 p	±0.1pF, ±0.25pF	490	200		0.125±0.013	R
TMK021 CG4R6	[K-W]		CG C0G	4.6 p	±0.1pF, ±0.25pF	492	200		0.125±0.013	R
TMK021 CG4R7	[K-W]		CG C0G	4.7 p	±0.1pF, ±0.25pF	494	200		0.125±0.013	R
TMK021 CG4R8	[K-W]		CG C0G	4.8 p	±0.1pF, ±0.25pF	496	200		0.125±0.013	R
TMK021 CG4R9	[K-W]		CG C0G	4.9 p	±0.1pF, ±0.25pF	498	200		0.125±0.013	R
TMK021 CG050	[K-W]		CG C0G	5 p	±0.1pF, ±0.25pF	500	200		0.125±0.013	R
TMK021 CG5R1	[K-W]		CG C0G	5.1 p	±0.25pF, ±0.5pF	502	200		0.125±0.013	R
TMK021 CG5R2	[K-W]		CG C0G	5.2 p	±0.25pF, ±0.5pF	504	200		0.125±0.013	R
TMK021 CG5R3	[K-W]		CG C0G	5.3 p	±0.25pF, ±0.5pF	506	200		0.125±0.013	R
TMK021 CG5R4	[K-W]		CG C0G	5.4 p	±0.25pF, ±0.5pF	508	200		0.125±0.013	R
TMK021 CG5R5	[K-W]		CG C0G	5.5 p	±0.25pF, ±0.5pF	510	200		0.125±0.013	R
TMK021 CG5R6	[K-W]		CG C0G	5.6 p	±0.25pF, ±0.5pF	512	200		0.125±0.013	R
TMK021 CG5R7	[K-W]		CG C0G	5.7 p	±0.25pF, ±0.5pF	514	200		0.125±0.013	R
TMK021 CG5R8	[K-W]		CG C0G	5.8 p	±0.25pF, ±0.5pF	516	200		0.125±0.013	R

▶ This catalog contains the typical specification only due to the limitation of space. When you consider the purchase of our products, please check our specification. For details of each product (characteristics graph, reliability information, precautions for use, and so on), see our Web site (<http://www.ty-top.com/>).

PARTS NUMBER

CERAMIC CAPACITORS

Part number 1	Part number 2	Rated voltage [V]	Temperature characteristics	Capacitance [F]	Capacitance tolerance [%]	Q (at 1MHz) min	HTLT		Thickness ^{*3} [mm]	Soldering R:Reflow W:Wave
							Rated voltage x %			
TMK021 CG5R9□K-W			CG C0G	5.9 p	±0.25pF, ±0.5pF	518	200		0.125±0.013	R
TMK021 CG060□K-W			CG C0G	6 p	±0.25pF, ±0.5pF	520	200		0.125±0.013	R
TMK021 CG6R1□K-W			CG C0G	6.1 p	±0.25pF, ±0.5pF	522	200		0.125±0.013	R
TMK021 CG6R2□K-W			CG C0G	6.2 p	±0.25pF, ±0.5pF	524	200		0.125±0.013	R
TMK021 CG6R3□K-W			CG C0G	6.3 p	±0.25pF, ±0.5pF	526	200		0.125±0.013	R
TMK021 CG6R4□K-W			CG C0G	6.4 p	±0.25pF, ±0.5pF	528	200		0.125±0.013	R
TMK021 CG6R5□K-W			CG C0G	6.5 p	±0.25pF, ±0.5pF	530	200		0.125±0.013	R
TMK021 CG6R6□K-W			CG C0G	6.6 p	±0.25pF, ±0.5pF	532	200		0.125±0.013	R
TMK021 CG6R7□K-W			CG C0G	6.7 p	±0.25pF, ±0.5pF	534	200		0.125±0.013	R
TMK021 CG6R8□K-W			CG C0G	6.8 p	±0.25pF, ±0.5pF	536	200		0.125±0.013	R
TMK021 CG6R9□K-W			CG C0G	6.9 p	±0.25pF, ±0.5pF	538	200		0.125±0.013	R
TMK021 CG070□K-W			CG C0G	7 p	±0.25pF, ±0.5pF	540	200		0.125±0.013	R
TMK021 CG7R1□K-W			CG C0G	7.1 p	±0.25pF, ±0.5pF	542	200		0.125±0.013	R
TMK021 CG7R2□K-W			CG C0G	7.2 p	±0.25pF, ±0.5pF	544	200		0.125±0.013	R
TMK021 CG7R3□K-W			CG C0G	7.3 p	±0.25pF, ±0.5pF	546	200		0.125±0.013	R
TMK021 CG7R4□K-W			CG C0G	7.4 p	±0.25pF, ±0.5pF	548	200		0.125±0.013	R
TMK021 CG7R5□K-W			CG C0G	7.5 p	±0.25pF, ±0.5pF	550	200		0.125±0.013	R
TMK021 CG7R6□K-W			CG C0G	7.6 p	±0.25pF, ±0.5pF	552	200		0.125±0.013	R
TMK021 CG7R7□K-W			CG C0G	7.7 p	±0.25pF, ±0.5pF	554	200		0.125±0.013	R
TMK021 CG7R8□K-W			CG C0G	7.8 p	±0.25pF, ±0.5pF	556	200		0.125±0.013	R
TMK021 CG7R9□K-W			CG C0G	7.9 p	±0.25pF, ±0.5pF	558	200		0.125±0.013	R
TMK021 CG080□K-W			CG C0G	8 p	±0.25pF, ±0.5pF	560	200		0.125±0.013	R
TMK021 CG8R1□K-W			CG C0G	8.1 p	±0.25pF, ±0.5pF	562	200		0.125±0.013	R
TMK021 CG8R2□K-W			CG C0G	8.2 p	±0.25pF, ±0.5pF	564	200		0.125±0.013	R
TMK021 CG8R3□K-W			CG C0G	8.3 p	±0.25pF, ±0.5pF	566	200		0.125±0.013	R
TMK021 CG8R4□K-W			CG C0G	8.4 p	±0.25pF, ±0.5pF	568	200		0.125±0.013	R
TMK021 CG8R5□K-W			CG C0G	8.5 p	±0.25pF, ±0.5pF	570	200		0.125±0.013	R
TMK021 CG8R6□K-W			CG C0G	8.6 p	±0.25pF, ±0.5pF	572	200		0.125±0.013	R
TMK021 CG8R7□K-W			CG C0G	8.7 p	±0.25pF, ±0.5pF	574	200		0.125±0.013	R
TMK021 CG8R8□K-W			CG C0G	8.8 p	±0.25pF, ±0.5pF	576	200		0.125±0.013	R
TMK021 CG8R9□K-W			CG C0G	8.9 p	±0.25pF, ±0.5pF	578	200		0.125±0.013	R
TMK021 CG090□K-W			CG C0G	9 p	±0.25pF, ±0.5pF	580	200		0.125±0.013	R
TMK021 CG9R1□K-W			CG C0G	9.1 p	±0.25pF, ±0.5pF	582	200		0.125±0.013	R
TMK021 CG9R2□K-W			CG C0G	9.2 p	±0.25pF, ±0.5pF	584	200		0.125±0.013	R
TMK021 CG9R3□K-W			CG C0G	9.3 p	±0.25pF, ±0.5pF	586	200		0.125±0.013	R
TMK021 CG9R4□K-W			CG C0G	9.4 p	±0.25pF, ±0.5pF	588	200		0.125±0.013	R
TMK021 CG9R5□K-W			CG C0G	9.5 p	±0.25pF, ±0.5pF	590	200		0.125±0.013	R
TMK021 CG9R6□K-W			CG C0G	9.6 p	±0.25pF, ±0.5pF	592	200		0.125±0.013	R
TMK021 CG9R7□K-W			CG C0G	9.7 p	±0.25pF, ±0.5pF	594	200		0.125±0.013	R
TMK021 CG9R8□K-W			CG C0G	9.8 p	±0.25pF, ±0.5pF	596	200		0.125±0.013	R
TMK021 CG9R9□K-W			CG C0G	9.9 p	±0.25pF, ±0.5pF	598	200		0.125±0.013	R
TMK021 CG100DK-W			CG C0G	10 p	±0.5pF	600	200		0.125±0.013	R

042TYPE

[Temperature Characteristic CG : CG/C0G] 0.2mm thickness(C.D)

Part number 1	Part number 2	Rated voltage [V]	Temperature characteristics	Capacitance [F]	Capacitance tolerance [%]	Q (at 1MHz) min	HTLT		Thickness ^{*3} [mm]	Soldering R:Reflow W:Wave
							Rated voltage x %			
TMK042 CG0R4□D-W			CG C0G	0.4 p	±0.05pF, ±0.1pF, ±0.25pF	408	200		0.2±0.02	R
TMK042 CG0R5□D-W			CG C0G	0.5 p	±0.05pF, ±0.1pF, ±0.25pF	410	200		0.2±0.02	R
TMK042 CG0R6□D-W			CG C0G	0.6 p	±0.05pF, ±0.1pF, ±0.25pF	412	200		0.2±0.02	R
TMK042 CG0R7□D-W			CG C0G	0.7 p	±0.05pF, ±0.1pF, ±0.25pF	414	200		0.2±0.02	R
TMK042 CGR75□D-W			CG C0G	0.75 p	±0.05pF, ±0.1pF, ±0.25pF	415	200		0.2±0.02	R
TMK042 CG0R8□D-W			CG C0G	0.8 p	±0.05pF, ±0.1pF, ±0.25pF	416	200		0.2±0.02	R
TMK042 CG0R9□D-W			CG C0G	0.9 p	±0.05pF, ±0.1pF, ±0.25pF	418	200		0.2±0.02	R
TMK042 CG010□D-W			CG C0G	1 p	±0.05pF, ±0.1pF, ±0.25pF	420	200		0.2±0.02	R
TMK042 CG1R1□D-W			CG C0G	1.1 p	±0.05pF, ±0.1pF, ±0.25pF	422	200		0.2±0.02	R
TMK042 CG1R2□D-W			CG C0G	1.2 p	±0.05pF, ±0.1pF, ±0.25pF	424	200		0.2±0.02	R
TMK042 CG1R3□D-W			CG C0G	1.3 p	±0.05pF, ±0.1pF, ±0.25pF	426	200		0.2±0.02	R
TMK042 CG1R4□D-W			CG C0G	1.4 p	±0.05pF, ±0.1pF, ±0.25pF	428	200		0.2±0.02	R
TMK042 CG1R5□D-W			CG C0G	1.5 p	±0.05pF, ±0.1pF, ±0.25pF	430	200		0.2±0.02	R
TMK042 CG1R6□D-W			CG C0G	1.6 p	±0.05pF, ±0.1pF, ±0.25pF	432	200		0.2±0.02	R
TMK042 CG1R7□D-W			CG C0G	1.7 p	±0.05pF, ±0.1pF, ±0.25pF	434	200		0.2±0.02	R
TMK042 CG1R8□D-W			CG C0G	1.8 p	±0.05pF, ±0.1pF, ±0.25pF	436	200		0.2±0.02	R
TMK042 CG1R9□D-W			CG C0G	1.9 p	±0.05pF, ±0.1pF, ±0.25pF	438	200		0.2±0.02	R
TMK042 CG020□D-W			CG C0G	2 p	±0.05pF, ±0.1pF, ±0.25pF	440	200		0.2±0.02	R
TMK042 CG2R1□D-W			CG C0G	2.1 p	±0.05pF, ±0.1pF, ±0.25pF	442	200		0.2±0.02	R
TMK042 CG2R2□D-W			CG C0G	2.2 p	±0.05pF, ±0.1pF, ±0.25pF	444	200		0.2±0.02	R
TMK042 CG2R3□D-W			CG C0G	2.3 p	±0.05pF, ±0.1pF, ±0.25pF	446	200		0.2±0.02	R
TMK042 CG2R4□D-W			CG C0G	2.4 p	±0.05pF, ±0.1pF, ±0.25pF	448	200		0.2±0.02	R
TMK042 CG2R5□D-W			CG C0G	2.5 p	±0.05pF, ±0.1pF, ±0.25pF	450	200		0.2±0.02	R
TMK042 CG2R6□D-W			CG C0G	2.6 p	±0.05pF, ±0.1pF, ±0.25pF	452	200		0.2±0.02	R
TMK042 CG2R7□D-W			CG C0G	2.7 p	±0.05pF, ±0.1pF, ±0.25pF	454	200		0.2±0.02	R
TMK042 CG2R8□D-W			CG C0G	2.8 p	±0.05pF, ±0.1pF, ±0.25pF	456	200		0.2±0.02	R
TMK042 CG2R9□D-W			CG C0G	2.9 p	±0.05pF, ±0.1pF, ±0.25pF	458	200		0.2±0.02	R
TMK042 CG030□D-W			CG C0G	3 p	±0.05pF, ±0.1pF, ±0.25pF	460	200		0.2±0.02	R
TMK042 CG3R1□D-W			CG C0G	3.1 p	±0.1pF, ±0.25pF	462	200		0.2±0.02	R
TMK042 CG3R2□D-W			CG C0G	3.2 p	±0.1pF, ±0.25pF	464	200		0.2±0.02	R
TMK042 CG3R3□D-W			CG C0G	3.3 p	±0.1pF, ±0.25pF	466	200		0.2±0.02	R
TMK042 CG3R4□D-W			CG C0G	3.4 p	±0.1pF, ±0.25pF	468	200		0.2±0.02	R
TMK042 CG3R5□D-W			CG C0G	3.5 p	±0.1pF, ±0.25pF	470	200		0.2±0.02	R
TMK042 CG3R6□D-W			CG C0G	3.6 p	±0.1pF, ±0.25pF	472	200		0.2±0.02	R
TMK042 CG3R7□D-W			CG C0G	3.7 p	±0.1pF, ±0.25pF	474	200		0.2±0.02	R
TMK042 CG3R8□D-W			CG C0G	3.8 p	±0.1pF, ±0.25pF	476	200		0.2±0.02	R
TMK042 CG3R9□D-W			CG C0G	3.9 p	±0.1pF, ±0.25pF	478	200		0.2±0.02	R
TMK042 CG040□D-W			CG C0G	4 p	±0.1pF, ±0.25pF	480	200		0.2±0.02	R
TMK042 CG4R1□D-W			CG C0G	4.1 p	±0.1pF, ±0.25pF	482	200		0.2±0.02	R
TMK042 CG4R2□D-W			CG C0G	4.2 p	±0.1pF, ±0.25pF	484	200		0.2±0.02	R
TMK042 CG4R3□D-W			CG C0G	4.3 p	±0.1pF, ±0.25pF	486	200		0.2±0.02	R
TMK042 CG4R4□D-W			CG C0G	4.4 p	±0.1pF, ±0.25pF	488	200		0.2±0.02	R

This catalog contains the typical specification only due to the limitation of space. When you consider the purchase of our products, please check our specification. For details of each product (characteristics graph, reliability information, precautions for use, and so on), see our Web site (<http://www.ty-top.com/>).

PARTS NUMBER

Part number 1	Part number 2	Rated voltage [V]	Temperature characteristics	Capacitance [F]	Capacitance tolerance [%]	Q (at 1MHz) min	HTLT	Thickness*3 [mm]	Soldering R:Reflow W:Wave
							Rated voltage x %		
TMK042 CG4R5[D-W		25	CG C0G	4.5 p	±0.1pF, ±0.25pF	490	200	0.2±0.02	R
TMK042 CG4R6[D-W			CG C0G	4.6 p	±0.1pF, ±0.25pF	492	200	0.2±0.02	R
TMK042 CG4R7[D-W			CG C0G	4.7 p	±0.1pF, ±0.25pF	494	200	0.2±0.02	R
TMK042 CG4R8[D-W			CG C0G	4.8 p	±0.1pF, ±0.25pF	496	200	0.2±0.02	R
TMK042 CG4R9[D-W			CG C0G	4.9 p	±0.1pF, ±0.25pF	498	200	0.2±0.02	R
TMK042 CG050[D-W			CG C0G	5 p	±0.1pF, ±0.25pF	500	200	0.2±0.02	R
TMK042 CG5R1[D-W			CG C0G	5.1 p	±0.1pF, ±0.25pF, ±0.5pF	502	200	0.2±0.02	R
TMK042 CG5R2[D-W			CG C0G	5.2 p	±0.1pF, ±0.25pF, ±0.5pF	504	200	0.2±0.02	R
TMK042 CG5R3[D-W			CG C0G	5.3 p	±0.1pF, ±0.25pF, ±0.5pF	506	200	0.2±0.02	R
TMK042 CG5R4[D-W			CG C0G	5.4 p	±0.1pF, ±0.25pF, ±0.5pF	508	200	0.2±0.02	R
TMK042 CG5R5[D-W			CG C0G	5.5 p	±0.1pF, ±0.25pF, ±0.5pF	510	200	0.2±0.02	R
TMK042 CG5R6[D-W			CG C0G	5.6 p	±0.1pF, ±0.25pF, ±0.5pF	512	200	0.2±0.02	R
TMK042 CG5R7[D-W			CG C0G	5.7 p	±0.1pF, ±0.25pF, ±0.5pF	514	200	0.2±0.02	R
TMK042 CG5R8[D-W			CG C0G	5.8 p	±0.1pF, ±0.25pF, ±0.5pF	516	200	0.2±0.02	R
TMK042 CG5R9[D-W			CG C0G	5.9 p	±0.1pF, ±0.25pF, ±0.5pF	518	200	0.2±0.02	R
TMK042 CG060[D-W			CG C0G	6 p	±0.1pF, ±0.25pF, ±0.5pF	520	200	0.2±0.02	R
TMK042 CG6R1[D-W			CG C0G	6.1 p	±0.1pF, ±0.25pF, ±0.5pF	522	200	0.2±0.02	R
TMK042 CG6R2[D-W			CG C0G	6.2 p	±0.1pF, ±0.25pF, ±0.5pF	524	200	0.2±0.02	R
TMK042 CG6R3[D-W			CG C0G	6.3 p	±0.1pF, ±0.25pF, ±0.5pF	526	200	0.2±0.02	R
TMK042 CG6R4[D-W			CG C0G	6.4 p	±0.1pF, ±0.25pF, ±0.5pF	528	200	0.2±0.02	R
TMK042 CG6R5[D-W			CG C0G	6.5 p	±0.1pF, ±0.25pF, ±0.5pF	530	200	0.2±0.02	R
TMK042 CG6R6[D-W			CG C0G	6.6 p	±0.1pF, ±0.25pF, ±0.5pF	532	200	0.2±0.02	R
TMK042 CG6R7[D-W			CG C0G	6.7 p	±0.1pF, ±0.25pF, ±0.5pF	534	200	0.2±0.02	R
TMK042 CG6R8[D-W			CG C0G	6.8 p	±0.1pF, ±0.25pF, ±0.5pF	536	200	0.2±0.02	R
TMK042 CG6R9[D-W			CG C0G	6.9 p	±0.1pF, ±0.25pF, ±0.5pF	538	200	0.2±0.02	R
TMK042 CG070[D-W			CG C0G	7 p	±0.1pF, ±0.25pF, ±0.5pF	540	200	0.2±0.02	R
TMK042 CG7R1[D-W			CG C0G	7.1 p	±0.1pF, ±0.25pF, ±0.5pF	542	200	0.2±0.02	R
TMK042 CG7R2[D-W			CG C0G	7.2 p	±0.1pF, ±0.25pF, ±0.5pF	544	200	0.2±0.02	R
TMK042 CG7R3[D-W			CG C0G	7.3 p	±0.1pF, ±0.25pF, ±0.5pF	546	200	0.2±0.02	R
TMK042 CG7R4[D-W			CG C0G	7.4 p	±0.1pF, ±0.25pF, ±0.5pF	548	200	0.2±0.02	R
TMK042 CG7R5[D-W			CG C0G	7.5 p	±0.1pF, ±0.25pF, ±0.5pF	550	200	0.2±0.02	R
TMK042 CG7R6[D-W			CG C0G	7.6 p	±0.1pF, ±0.25pF, ±0.5pF	552	200	0.2±0.02	R
TMK042 CG7R7[D-W			CG C0G	7.7 p	±0.1pF, ±0.25pF, ±0.5pF	554	200	0.2±0.02	R
TMK042 CG7R8[D-W			CG C0G	7.8 p	±0.1pF, ±0.25pF, ±0.5pF	556	200	0.2±0.02	R
TMK042 CG7R9[D-W			CG C0G	7.9 p	±0.1pF, ±0.25pF, ±0.5pF	558	200	0.2±0.02	R
TMK042 CG080[D-W			CG C0G	8 p	±0.1pF, ±0.25pF, ±0.5pF	560	200	0.2±0.02	R
TMK042 CG8R1[D-W			CG C0G	8.1 p	±0.1pF, ±0.25pF, ±0.5pF	562	200	0.2±0.02	R
TMK042 CG8R2[D-W			CG C0G	8.2 p	±0.1pF, ±0.25pF, ±0.5pF	564	200	0.2±0.02	R
TMK042 CG8R3[D-W			CG C0G	8.3 p	±0.1pF, ±0.25pF, ±0.5pF	566	200	0.2±0.02	R
TMK042 CG8R4[D-W			CG C0G	8.4 p	±0.1pF, ±0.25pF, ±0.5pF	568	200	0.2±0.02	R
TMK042 CG8R5[D-W			CG C0G	8.5 p	±0.1pF, ±0.25pF, ±0.5pF	570	200	0.2±0.02	R
TMK042 CG8R6[D-W			CG C0G	8.6 p	±0.1pF, ±0.25pF, ±0.5pF	572	200	0.2±0.02	R
TMK042 CG8R7[D-W			CG C0G	8.7 p	±0.1pF, ±0.25pF, ±0.5pF	574	200	0.2±0.02	R
TMK042 CG8R8[D-W			CG C0G	8.8 p	±0.1pF, ±0.25pF, ±0.5pF	576	200	0.2±0.02	R
TMK042 CG8R9[D-W			CG C0G	8.9 p	±0.1pF, ±0.25pF, ±0.5pF	578	200	0.2±0.02	R
TMK042 CG090[D-W			CG C0G	9 p	±0.1pF, ±0.25pF, ±0.5pF	580	200	0.2±0.02	R
TMK042 CG9R1[D-W			CG C0G	9.1 p	±0.1pF, ±0.25pF, ±0.5pF	582	200	0.2±0.02	R
TMK042 CG9R2[D-W			CG C0G	9.2 p	±0.1pF, ±0.25pF, ±0.5pF	584	200	0.2±0.02	R
TMK042 CG9R3[D-W			CG C0G	9.3 p	±0.1pF, ±0.25pF, ±0.5pF	586	200	0.2±0.02	R
TMK042 CG9R4[D-W			CG C0G	9.4 p	±0.1pF, ±0.25pF, ±0.5pF	588	200	0.2±0.02	R
TMK042 CG9R5[D-W			CG C0G	9.5 p	±0.1pF, ±0.25pF, ±0.5pF	590	200	0.2±0.02	R
TMK042 CG9R6[D-W			CG C0G	9.6 p	±0.1pF, ±0.25pF, ±0.5pF	592	200	0.2±0.02	R
TMK042 CG9R7[D-W			CG C0G	9.7 p	±0.1pF, ±0.25pF, ±0.5pF	594	200	0.2±0.02	R
TMK042 CG9R8[D-W			CG C0G	9.8 p	±0.1pF, ±0.25pF, ±0.5pF	596	200	0.2±0.02	R
TMK042 CG9R9[D-W			CG C0G	9.9 p	±0.1pF, ±0.25pF, ±0.5pF	598	200	0.2±0.02	R
TMK042 CG100DD-W			CG C0G	10 p	±5%	600	200	0.2±0.02	R
TMK042 CG110JD-W			CG C0G	11 p	±5%	620	200	0.2±0.02	R
TMK042 CG120JD-W			CG C0G	12 p	±5%	640	200	0.2±0.02	R
TMK042 CG130JD-W			CG C0G	13 p	±5%	660	200	0.2±0.02	R
TMK042 CG150JD-W			CG C0G	15 p	±5%	700	200	0.2±0.02	R
TMK042 CG160JC-W			CG C0G	16 p	±5%	720	200	0.2±0.02	R
TMK042 CG180JC-W			CG C0G	18 p	±5%	760	200	0.2±0.02	R
TMK042 CG200JC-W			CG C0G	20 p	±5%	800	200	0.2±0.02	R
TMK042 CG220JC-W			CG C0G	22 p	±5%	840	200	0.2±0.02	R
TMK042 CG240JC-W			CG C0G	24 p	±5%	880	200	0.2±0.02	R
TMK042 CG270JC-W			CG C0G	27 p	±5%	940	200	0.2±0.02	R
TMK042 CG300JC-W			CG C0G	30 p	±5%	1000	200	0.2±0.02	R
TMK042 CG330JC-W			CG C0G	33 p	±5%	1000	200	0.2±0.02	R
TMK042 CG360JC-W			CG C0G	36 p	±5%	1000	200	0.2±0.02	R
TMK042 CG390JC-W			CG C0G	39 p	±5%	1000	200	0.2±0.02	R
TMK042 CG430JC-W			CG C0G	43 p	±5%	1000	200	0.2±0.02	R
TMK042 CG470JC-W			CG C0G	47 p	±5%	1000	200	0.2±0.02	R
TMK042 CG510JC-W			CG C0G	51 p	±5%	1000	200	0.2±0.02	R
TMK042 CG560JC-W			CG C0G	56 p	±5%	1000	200	0.2±0.02	R
TMK042 CG620JC-W			CG C0G	62 p	±5%	1000	200	0.2±0.02	R
TMK042 CG680JC-W			CG C0G	68 p	±5%	1000	200	0.2±0.02	R
TMK042 CG750JC-W			CG C0G	75 p	±5%	1000	200	0.2±0.02	R
TMK042 CG820JC-W			CG C0G	82 p	±5%	1000	200	0.2±0.02	R
TMK042 CG910JC-W			CG C0G	91 p	±5%	1000	200	0.2±0.02	R
TMK042 CG101JC-W			CG C0G	100 p	±5%	1000	200	0.2±0.02	R

▶ This catalog contains the typical specification only due to the limitation of space. When you consider the purchase of our products, please check our specification. For details of each product (characteristics graph, reliability information, precautions for use, and so on), see our Web site (<http://www.ty-top.com/>).

PARTS NUMBER

[Temperature Characteristic CG : CG/COG] 0.2mm thickness (C.D)

Part number 1	Part number 2	Rated voltage [V]	Temperature characteristics	Capacitance [F]	Capacitance tolerance [%]	Q (at 1MHz) min	HTLT	Thickness*3 [mm]	Soldering R:Reflow W:Wave
							Rated voltage x %		
EMK042 CG0R4□D-W		CG	COG	0.4 p	±0.05pF, ±0.1pF, ±0.25pF	408	200	0.2±0.02	R
EMK042 CG0R5□D-W		CG	COG	0.5 p	±0.05pF, ±0.1pF, ±0.25pF	410	200	0.2±0.02	R
EMK042 CG0R6□D-W		CG	COG	0.6 p	±0.05pF, ±0.1pF, ±0.25pF	412	200	0.2±0.02	R
EMK042 CG0R7□D-W		CG	COG	0.7 p	±0.05pF, ±0.1pF, ±0.25pF	414	200	0.2±0.02	R
EMK042 CGR75□D-W		CG	COG	0.75 p	±0.05pF, ±0.1pF, ±0.25pF	415	200	0.2±0.02	R
EMK042 CG0R8□D-W		CG	COG	0.8 p	±0.05pF, ±0.1pF, ±0.25pF	416	200	0.2±0.02	R
EMK042 CG0R9□D-W		CG	COG	0.9 p	±0.05pF, ±0.1pF, ±0.25pF	418	200	0.2±0.02	R
EMK042 CG010□D-W		CG	COG	1 p	±0.05pF, ±0.1pF, ±0.25pF	420	200	0.2±0.02	R
EMK042 CG1R1□D-W		CG	COG	1.1 p	±0.05pF, ±0.1pF, ±0.25pF	422	200	0.2±0.02	R
EMK042 CG1R2□D-W		CG	COG	1.2 p	±0.05pF, ±0.1pF, ±0.25pF	424	200	0.2±0.02	R
EMK042 CG1R3□D-W		CG	COG	1.3 p	±0.05pF, ±0.1pF, ±0.25pF	426	200	0.2±0.02	R
EMK042 CG1R4□D-W		CG	COG	1.4 p	±0.05pF, ±0.1pF, ±0.25pF	428	200	0.2±0.02	R
EMK042 CG1R5□D-W		CG	COG	1.5 p	±0.05pF, ±0.1pF, ±0.25pF	430	200	0.2±0.02	R
EMK042 CG1R6□D-W		CG	COG	1.6 p	±0.05pF, ±0.1pF, ±0.25pF	432	200	0.2±0.02	R
EMK042 CG1R7□D-W		CG	COG	1.7 p	±0.05pF, ±0.1pF, ±0.25pF	434	200	0.2±0.02	R
EMK042 CG1R8□D-W		CG	COG	1.8 p	±0.05pF, ±0.1pF, ±0.25pF	436	200	0.2±0.02	R
EMK042 CG1R9□D-W		CG	COG	1.9 p	±0.05pF, ±0.1pF, ±0.25pF	438	200	0.2±0.02	R
EMK042 CG020□D-W		CG	COG	2 p	±0.05pF, ±0.1pF, ±0.25pF	440	200	0.2±0.02	R
EMK042 CG2R1□D-W		CG	COG	2.1 p	±0.05pF, ±0.1pF, ±0.25pF	442	200	0.2±0.02	R
EMK042 CG2R2□D-W		CG	COG	2.2 p	±0.05pF, ±0.1pF, ±0.25pF	444	200	0.2±0.02	R
EMK042 CG2R3□D-W		CG	COG	2.3 p	±0.05pF, ±0.1pF, ±0.25pF	446	200	0.2±0.02	R
EMK042 CG2R4□D-W		CG	COG	2.4 p	±0.05pF, ±0.1pF, ±0.25pF	448	200	0.2±0.02	R
EMK042 CG2R5□D-W		CG	COG	2.5 p	±0.05pF, ±0.1pF, ±0.25pF	450	200	0.2±0.02	R
EMK042 CG2R6□D-W		CG	COG	2.6 p	±0.05pF, ±0.1pF, ±0.25pF	452	200	0.2±0.02	R
EMK042 CG2R7□D-W		CG	COG	2.7 p	±0.05pF, ±0.1pF, ±0.25pF	454	200	0.2±0.02	R
EMK042 CG2R8□D-W		CG	COG	2.8 p	±0.05pF, ±0.1pF, ±0.25pF	456	200	0.2±0.02	R
EMK042 CG2R9□D-W		CG	COG	2.9 p	±0.05pF, ±0.1pF, ±0.25pF	458	200	0.2±0.02	R
EMK042 CG030□D-W		CG	COG	3 p	±0.05pF, ±0.1pF, ±0.25pF	460	200	0.2±0.02	R
EMK042 CG3R1□D-W		CG	COG	3.1 p	±0.1pF, ±0.25pF	462	200	0.2±0.02	R
EMK042 CG3R2□D-W		CG	COG	3.2 p	±0.1pF, ±0.25pF	464	200	0.2±0.02	R
EMK042 CG3R3□D-W		CG	COG	3.3 p	±0.1pF, ±0.25pF	466	200	0.2±0.02	R
EMK042 CG3R4□D-W		CG	COG	3.4 p	±0.1pF, ±0.25pF	468	200	0.2±0.02	R
EMK042 CG3R5□D-W		CG	COG	3.5 p	±0.1pF, ±0.25pF	470	200	0.2±0.02	R
EMK042 CG3R6□D-W		CG	COG	3.6 p	±0.1pF, ±0.25pF	472	200	0.2±0.02	R
EMK042 CG3R7□D-W		CG	COG	3.7 p	±0.1pF, ±0.25pF	474	200	0.2±0.02	R
EMK042 CG3R8□D-W		CG	COG	3.8 p	±0.1pF, ±0.25pF	476	200	0.2±0.02	R
EMK042 CG3R9□D-W		CG	COG	3.9 p	±0.1pF, ±0.25pF	478	200	0.2±0.02	R
EMK042 CG040□D-W		CG	COG	4 p	±0.1pF, ±0.25pF	480	200	0.2±0.02	R
EMK042 CG4R1□D-W		CG	COG	4.1 p	±0.1pF, ±0.25pF	482	200	0.2±0.02	R
EMK042 CG4R2□D-W		CG	COG	4.2 p	±0.1pF, ±0.25pF	484	200	0.2±0.02	R
EMK042 CG4R3□D-W		CG	COG	4.3 p	±0.1pF, ±0.25pF	486	200	0.2±0.02	R
EMK042 CG4R4□D-W		CG	COG	4.4 p	±0.1pF, ±0.25pF	488	200	0.2±0.02	R
EMK042 CG4R5□D-W		CG	COG	4.5 p	±0.1pF, ±0.25pF	490	200	0.2±0.02	R
EMK042 CG4R6□D-W		CG	COG	4.6 p	±0.1pF, ±0.25pF	492	200	0.2±0.02	R
EMK042 CG4R7□D-W		CG	COG	4.7 p	±0.1pF, ±0.25pF	494	200	0.2±0.02	R
EMK042 CG4R8□D-W		CG	COG	4.8 p	±0.1pF, ±0.25pF	496	200	0.2±0.02	R
EMK042 CG4R9□D-W		CG	COG	4.9 p	±0.1pF, ±0.25pF	498	200	0.2±0.02	R
EMK042 CG050□D-W		CG	COG	5 p	±0.1pF, ±0.25pF	500	200	0.2±0.02	R
EMK042 CG5R1□D-W		CG	COG	5.1 p	±0.1pF, ±0.25pF, ±0.5pF	502	200	0.2±0.02	R
EMK042 CG5R2□D-W		CG	COG	5.2 p	±0.1pF, ±0.25pF, ±0.5pF	504	200	0.2±0.02	R
EMK042 CG5R3□D-W		CG	COG	5.3 p	±0.1pF, ±0.25pF, ±0.5pF	506	200	0.2±0.02	R
EMK042 CG5R4□D-W		CG	COG	5.4 p	±0.1pF, ±0.25pF, ±0.5pF	508	200	0.2±0.02	R
EMK042 CG5R5□D-W		CG	COG	5.5 p	±0.1pF, ±0.25pF, ±0.5pF	510	200	0.2±0.02	R
EMK042 CG5R6□D-W		CG	COG	5.6 p	±0.1pF, ±0.25pF, ±0.5pF	512	200	0.2±0.02	R
EMK042 CG5R7□D-W		CG	COG	5.7 p	±0.1pF, ±0.25pF, ±0.5pF	514	200	0.2±0.02	R
EMK042 CG5R8□D-W		CG	COG	5.8 p	±0.1pF, ±0.25pF, ±0.5pF	516	200	0.2±0.02	R
EMK042 CG5R9□D-W		CG	COG	5.9 p	±0.1pF, ±0.25pF, ±0.5pF	518	200	0.2±0.02	R
EMK042 CG060□D-W		CG	COG	6 p	±0.1pF, ±0.25pF, ±0.5pF	520	200	0.2±0.02	R
EMK042 CG6R1□D-W		CG	COG	6.1 p	±0.1pF, ±0.25pF, ±0.5pF	522	200	0.2±0.02	R
EMK042 CG6R2□D-W		CG	COG	6.2 p	±0.1pF, ±0.25pF, ±0.5pF	524	200	0.2±0.02	R
EMK042 CG6R3□D-W		CG	COG	6.3 p	±0.1pF, ±0.25pF, ±0.5pF	526	200	0.2±0.02	R
EMK042 CG6R4□D-W		CG	COG	6.4 p	±0.1pF, ±0.25pF, ±0.5pF	528	200	0.2±0.02	R
EMK042 CG6R5□D-W		CG	COG	6.5 p	±0.1pF, ±0.25pF, ±0.5pF	530	200	0.2±0.02	R
EMK042 CG6R6□D-W		CG	COG	6.6 p	±0.1pF, ±0.25pF, ±0.5pF	532	200	0.2±0.02	R
EMK042 CG6R7□D-W		CG	COG	6.7 p	±0.1pF, ±0.25pF, ±0.5pF	534	200	0.2±0.02	R
EMK042 CG6R8□D-W		CG	COG	6.8 p	±0.1pF, ±0.25pF, ±0.5pF	536	200	0.2±0.02	R
EMK042 CG6R9□D-W		CG	COG	6.9 p	±0.1pF, ±0.25pF, ±0.5pF	538	200	0.2±0.02	R
EMK042 CG070□D-W		CG	COG	7 p	±0.1pF, ±0.25pF, ±0.5pF	540	200	0.2±0.02	R
EMK042 CG7R1□D-W		CG	COG	7.1 p	±0.1pF, ±0.25pF, ±0.5pF	542	200	0.2±0.02	R
EMK042 CG7R2□D-W		CG	COG	7.2 p	±0.1pF, ±0.25pF, ±0.5pF	544	200	0.2±0.02	R
EMK042 CG7R3□D-W		CG	COG	7.3 p	±0.1pF, ±0.25pF, ±0.5pF	546	200	0.2±0.02	R
EMK042 CG7R4□D-W		CG	COG	7.4 p	±0.1pF, ±0.25pF, ±0.5pF	548	200	0.2±0.02	R
EMK042 CG7R5□D-W		CG	COG	7.5 p	±0.1pF, ±0.25pF, ±0.5pF	550	200	0.2±0.02	R
EMK042 CG7R6□D-W		CG	COG	7.6 p	±0.1pF, ±0.25pF, ±0.5pF	552	200	0.2±0.02	R
EMK042 CG7R7□D-W		CG	COG	7.7 p	±0.1pF, ±0.25pF, ±0.5pF	554	200	0.2±0.02	R
EMK042 CG7R8□D-W		CG	COG	7.8 p	±0.1pF, ±0.25pF, ±0.5pF	556	200	0.2±0.02	R
EMK042 CG7R9□D-W		CG	COG	7.9 p	±0.1pF, ±0.25pF, ±0.5pF	558	200	0.2±0.02	R
EMK042 CG080□D-W		CG	COG	8 p	±0.1pF, ±0.25pF, ±0.5pF	560	200	0.2±0.02	R
EMK042 CG8R1□D-W		CG	COG	8.1 p	±0.1pF, ±0.25pF, ±0.5pF	562	200	0.2±0.02	R
EMK042 CG8R2□D-W		CG	COG	8.2 p	±0.1pF, ±0.25pF, ±0.5pF	564	200	0.2±0.02	R
EMK042 CG8R3□D-W		CG	COG	8.3 p	±0.1pF, ±0.25pF, ±0.5pF	566	200	0.2±0.02	R
EMK042 CG8R4□D-W		CG	COG	8.4 p	±0.1pF, ±0.25pF, ±0.5pF	568	200	0.2±0.02	R
EMK042 CG8R5□D-W		CG	COG	8.5 p	±0.1pF, ±0.25pF, ±0.5pF	570	200	0.2±0.02	R
EMK042 CG8R6□D-W		CG	COG	8.6 p	±0.1pF, ±0.25pF, ±0.5pF	572	200	0.2±0.02	R
EMK042 CG8R7□D-W		CG	COG	8.7 p	±0.1pF, ±0.25pF, ±0.5pF	574	200	0.2±0.02	R
EMK042 CG8R8□D-W		CG	COG	8.8 p	±0.1pF, ±0.25pF, ±0.5pF	576	200	0.2±0.02	R
EMK042 CG8R9□D-W		CG	COG	8.9 p	±0.1pF, ±0.25pF, ±0.5pF	578	200	0.2±0.02	R
EMK042 CG090□D-W		CG	COG	9 p	±0.1pF, ±0.25pF, ±0.5pF	580	200	0.2±0.02	R
EMK042 CG9R1□D-W		CG	COG	9.1 p	±0.1pF, ±0.25pF, ±0.5pF	582	200	0.2±0.02	R

CERAMIC CAPACITORS

16

► This catalog contains the typical specification only due to the limitation of space. When you consider the purchase of our products, please check our specification. For details of each product (characteristics graph, reliability information, precautions for use, and so on), see our Web site (<http://www.ty-top.com/>).

PARTS NUMBER

Part number 1	Part number 2	Rated voltage [V]	Temperature characteristics		Capacitance [F]	Capacitance tolerance [%]	Q (at 1MHz) min	HTLT		Thickness*3 [mm]	Soldering R:Reflow W:Wave
								Rated voltage x %			
EMK042 CG9R2[D-W		16	CG	COG	9.2 p	±0.1pF, ±0.25pF, ±0.5pF	584	200		0.2±0.02	R
EMK042 CG9R3[D-W			CG	COG	9.3 p	±0.1pF, ±0.25pF, ±0.5pF	586	200		0.2±0.02	R
EMK042 CG9R4[D-W			CG	COG	9.4 p	±0.1pF, ±0.25pF, ±0.5pF	588	200		0.2±0.02	R
EMK042 CG9R5[D-W			CG	COG	9.5 p	±0.1pF, ±0.25pF, ±0.5pF	590	200		0.2±0.02	R
EMK042 CG9R6[D-W			CG	COG	9.6 p	±0.1pF, ±0.25pF, ±0.5pF	592	200		0.2±0.02	R
EMK042 CG9R7[D-W			CG	COG	9.7 p	±0.1pF, ±0.25pF, ±0.5pF	594	200		0.2±0.02	R
EMK042 CG9R8[D-W			CG	COG	9.8 p	±0.1pF, ±0.25pF, ±0.5pF	596	200		0.2±0.02	R
EMK042 CG9R9[D-W			CG	COG	9.9 p	±0.1pF, ±0.25pF, ±0.5pF	598	200		0.2±0.02	R
EMK042 CG100DD-W			CG	COG	10 p	±0.5pF	600	200		0.2±0.02	R
EMK042 CG110JD-W			CG	COG	11 p	±5%	620	200		0.2±0.02	R
EMK042 CG120JD-W			CG	COG	12 p	±5%	640	200		0.2±0.02	R
EMK042 CG130JD-W			CG	COG	13 p	±5%	660	200		0.2±0.02	R
EMK042 CG150JD-W			CG	COG	15 p	±5%	700	200		0.2±0.02	R
EMK042 CG160JC-W			CG	COG	16 p	±5%	720	200		0.2±0.02	R
EMK042 CG180JC-W			CG	COG	18 p	±5%	760	200		0.2±0.02	R
EMK042 CG200JC-W			CG	COG	20 p	±5%	800	200		0.2±0.02	R
EMK042 CG220JC-W			CG	COG	22 p	±5%	840	200		0.2±0.02	R
EMK042 CG240JC-W			CG	COG	24 p	±5%	880	200		0.2±0.02	R
EMK042 CG270JC-W			CG	COG	27 p	±5%	940	200		0.2±0.02	R
EMK042 CG300JC-W			CG	COG	30 p	±5%	1000	200		0.2±0.02	R
EMK042 CG330JC-W			CG	COG	33 p	±5%	1000	200		0.2±0.02	R
EMK042 CG360JC-W			CG	COG	36 p	±5%	1000	200		0.2±0.02	R
EMK042 CG390JC-W			CG	COG	39 p	±5%	1000	200		0.2±0.02	R
EMK042 CG430JC-W			CG	COG	43 p	±5%	1000	200		0.2±0.02	R
EMK042 CG470JC-W			CG	COG	47 p	±5%	1000	200		0.2±0.02	R
EMK042 CG510JC-W			CG	COG	51 p	±5%	1000	200		0.2±0.02	R
EMK042 CG560JC-W			CG	COG	56 p	±5%	1000	200		0.2±0.02	R
EMK042 CG620JC-W			CG	COG	62 p	±5%	1000	200		0.2±0.02	R
EMK042 CG680JC-W			CG	COG	68 p	±5%	1000	200		0.2±0.02	R
EMK042 CG750JC-W			CG	COG	75 p	±5%	1000	200		0.2±0.02	R
EMK042 CG820JC-W			CG	COG	82 p	±5%	1000	200		0.2±0.02	R
EMK042 CG910JC-W			CG	COG	91 p	±5%	1000	200		0.2±0.02	R
EMK042 CG101JC-W			CG	COG	100 p	±5%	1000	200		0.2±0.02	R

[Temperature Characteristic CΔ : CΔ/COΔ] 0.2mm thickness (C,D)

Part number 1	Part number 2	Rated voltage [V]	Temperature characteristics		Capacitance [F]	Capacitance tolerance [%]	Q (at 1MHz) min	HTLT		Thickness*3 [mm]	Soldering R:Reflow W:Wave
								Rated voltage x %			
TMK042 CK0R4[D-W		25	CK	COK	0.4 p	±0.05pF, ±0.1pF, ±0.25pF	408	200		0.2±0.02	R
TMK042 CK0R5[D-W			CK	COK	0.5 p	±0.05pF, ±0.1pF, ±0.25pF	410	200		0.2±0.02	R
TMK042 CK0R6[D-W			CK	COK	0.6 p	±0.05pF, ±0.1pF, ±0.25pF	412	200		0.2±0.02	R
TMK042 CK0R7[D-W			CK	COK	0.7 p	±0.05pF, ±0.1pF, ±0.25pF	414	200		0.2±0.02	R
TMK042 CKR75[D-W			CK	COK	0.75 p	±0.05pF, ±0.1pF, ±0.25pF	415	200		0.2±0.02	R
TMK042 CK0R8[D-W			CK	COK	0.8 p	±0.05pF, ±0.1pF, ±0.25pF	416	200		0.2±0.02	R
TMK042 CK0R9[D-W			CK	COK	0.9 p	±0.05pF, ±0.1pF, ±0.25pF	418	200		0.2±0.02	R
TMK042 CK010[D-W			CK	COK	1 p	±0.05pF, ±0.1pF, ±0.25pF	420	200		0.2±0.02	R
TMK042 CK1R1[D-W			CK	COK	1.1 p	±0.05pF, ±0.1pF, ±0.25pF	422	200		0.2±0.02	R
TMK042 CK1R2[D-W			CK	COK	1.2 p	±0.05pF, ±0.1pF, ±0.25pF	424	200		0.2±0.02	R
TMK042 CK1R3[D-W			CK	COK	1.3 p	±0.05pF, ±0.1pF, ±0.25pF	426	200		0.2±0.02	R
TMK042 CK1R4[D-W			CK	COK	1.4 p	±0.05pF, ±0.1pF, ±0.25pF	428	200		0.2±0.02	R
TMK042 CK1R5[D-W			CK	COK	1.5 p	±0.05pF, ±0.1pF, ±0.25pF	430	200		0.2±0.02	R
TMK042 CK1R6[D-W			CK	COK	1.6 p	±0.05pF, ±0.1pF, ±0.25pF	432	200		0.2±0.02	R
TMK042 CK1R7[D-W			CK	COK	1.7 p	±0.05pF, ±0.1pF, ±0.25pF	434	200		0.2±0.02	R
TMK042 CK1R8[D-W			CK	COK	1.8 p	±0.05pF, ±0.1pF, ±0.25pF	436	200		0.2±0.02	R
TMK042 CK1R9[D-W			CK	COK	1.9 p	±0.05pF, ±0.1pF, ±0.25pF	438	200		0.2±0.02	R
TMK042 CK020[D-W			CK	COK	2 p	±0.05pF, ±0.1pF, ±0.25pF	440	200		0.2±0.02	R
TMK042 CK2R1[D-W			CK	COK	2.1 p	±0.05pF, ±0.1pF, ±0.25pF	442	200		0.2±0.02	R
TMK042 CK2R2[D-W			CK	COK	2.2 p	±0.05pF, ±0.1pF, ±0.25pF	444	200		0.2±0.02	R
TMK042 CK2R3[D-W			CK	COK	2.3 p	±0.05pF, ±0.1pF, ±0.25pF	446	200		0.2±0.02	R
TMK042 CK2R4[D-W			CK	COK	2.4 p	±0.05pF, ±0.1pF, ±0.25pF	448	200		0.2±0.02	R
TMK042 CK2R5[D-W			CK	COK	2.5 p	±0.05pF, ±0.1pF, ±0.25pF	450	200		0.2±0.02	R
TMK042 CK2R6[D-W			CK	COK	2.6 p	±0.05pF, ±0.1pF, ±0.25pF	452	200		0.2±0.02	R
TMK042 CK2R7[D-W			CK	COK	2.7 p	±0.05pF, ±0.1pF, ±0.25pF	454	200		0.2±0.02	R
TMK042 CK2R8[D-W			CK	COK	2.8 p	±0.05pF, ±0.1pF, ±0.25pF	456	200		0.2±0.02	R
TMK042 CK2R9[D-W			CK	COK	2.9 p	±0.05pF, ±0.1pF, ±0.25pF	458	200		0.2±0.02	R
TMK042 CJ030[D-W			CJ	COJ	3 p	±0.05pF, ±0.1pF, ±0.25pF	460	200		0.2±0.02	R
TMK042 CJ3R1[D-W			CJ	COJ	3.1 p	±0.1pF, ±0.25pF	462	200		0.2±0.02	R
TMK042 CJ3R2[D-W			CJ	COJ	3.2 p	±0.1pF, ±0.25pF	464	200		0.2±0.02	R
TMK042 CJ3R3[D-W			CJ	COJ	3.3 p	±0.1pF, ±0.25pF	466	200		0.2±0.02	R
TMK042 CJ3R4[D-W			CJ	COJ	3.4 p	±0.1pF, ±0.25pF	468	200		0.2±0.02	R
TMK042 CJ3R5[D-W			CJ	COJ	3.5 p	±0.1pF, ±0.25pF	470	200		0.2±0.02	R
TMK042 CJ3R6[D-W			CJ	COJ	3.6 p	±0.1pF, ±0.25pF	472	200		0.2±0.02	R
TMK042 CJ3R7[D-W			CJ	COJ	3.7 p	±0.1pF, ±0.25pF	474	200		0.2±0.02	R
TMK042 CJ3R8[D-W			CJ	COJ	3.8 p	±0.1pF, ±0.25pF	476	200		0.2±0.02	R
TMK042 CJ3R9[D-W			CJ	COJ	3.9 p	±0.1pF, ±0.25pF	478	200		0.2±0.02	R
TMK042 CH040[D-W			CH	COH	4 p	±0.1pF, ±0.25pF	480	200		0.2±0.02	R
TMK042 CH4R1[D-W			CH	COH	4.1 p	±0.1pF, ±0.25pF	482	200		0.2±0.02	R
TMK042 CH4R2[D-W			CH	COH	4.2 p	±0.1pF, ±0.25pF	484	200		0.2±0.02	R
TMK042 CH4R3[D-W			CH	COH	4.3 p	±0.1pF, ±0.25pF	486	200		0.2±0.02	R
TMK042 CH4R4[D-W			CH	COH	4.4 p	±0.1pF, ±0.25pF	488	200		0.2±0.02	R
TMK042 CH4R5[D-W			CH	COH	4.5 p	±0.1pF, ±0.25pF	490	200		0.2±0.02	R
TMK042 CH4R6[D-W			CH	COH	4.6 p	±0.1pF, ±0.25pF	492	200		0.2±0.02	R
TMK042 CH4R7[D-W			CH	COH	4.7 p	±0.1pF, ±0.25pF	494	200		0.2±0.02	R
TMK042 CH4R8[D-W			CH	COH	4.8 p	±0.1pF, ±0.25pF	496	200		0.2±0.02	R
TMK042 CH4R9[D-W			CH	COH	4.9 p	±0.1pF, ±0.25pF	498	200		0.2±0.02	R
TMK042 CH050[D-W			CH	COH	5 p	±0.1pF, ±0.25pF	500	200		0.2±0.02	R
TMK042 CH5R1[D-W		CH	COH	5.1 p	±0.1pF, ±0.25pF, ±0.5pF	502	200		0.2±0.02	R	
TMK042 CH5R2[D-W		CH	COH	5.2 p	±0.1pF, ±0.25pF, ±0.5pF	504	200		0.2±0.02	R	
TMK042 CH5R3[D-W		CH	COH	5.3 p	±0.1pF, ±0.25pF, ±0.5pF	506	200		0.2±0.02	R	
TMK042 CH5R4[D-W		CH	COH	5.4 p	±0.1pF, ±0.25pF, ±0.5pF	508	200		0.2±0.02	R	

▶ This catalog contains the typical specification only due to the limitation of space. When you consider the purchase of our products, please check our specification. For details of each product (characteristics graph, reliability information, precautions for use, and so on), see our Web site (<http://www.ty-top.com/>).

PARTS NUMBER

CERAMIC CAPACITORS

Part number 1	Part number 2	Rated voltage [V]	Temperature characteristics	Capacitance [F]	Capacitance tolerance [%]	Q (at 1MHz) min	HTLT	Thickness*3 [mm]	Soldering R:Reflow W:Wave
							Rated voltage x %		
TMK042 CH5R5□D-W		25	CH C0H	5.5 p	±0.1pF, ±0.25pF, ±0.5pF	510	200	0.2±0.02	R
TMK042 CH5R6□D-W			CH C0H	5.6 p	±0.1pF, ±0.25pF, ±0.5pF	512	200	0.2±0.02	R
TMK042 CH5R7□D-W			CH C0H	5.7 p	±0.1pF, ±0.25pF, ±0.5pF	514	200	0.2±0.02	R
TMK042 CH5R8□D-W			CH C0H	5.8 p	±0.1pF, ±0.25pF, ±0.5pF	516	200	0.2±0.02	R
TMK042 CH5R9□D-W			CH C0H	5.9 p	±0.1pF, ±0.25pF, ±0.5pF	518	200	0.2±0.02	R
TMK042 CH060□D-W			CH C0H	6 p	±0.1pF, ±0.25pF, ±0.5pF	520	200	0.2±0.02	R
TMK042 CH6R1□D-W			CH C0H	6.1 p	±0.1pF, ±0.25pF, ±0.5pF	522	200	0.2±0.02	R
TMK042 CH6R2□D-W			CH C0H	6.2 p	±0.1pF, ±0.25pF, ±0.5pF	524	200	0.2±0.02	R
TMK042 CH6R3□D-W			CH C0H	6.3 p	±0.1pF, ±0.25pF, ±0.5pF	526	200	0.2±0.02	R
TMK042 CH6R4□D-W			CH C0H	6.4 p	±0.1pF, ±0.25pF, ±0.5pF	528	200	0.2±0.02	R
TMK042 CH6R5□D-W			CH C0H	6.5 p	±0.1pF, ±0.25pF, ±0.5pF	530	200	0.2±0.02	R
TMK042 CH6R6□D-W			CH C0H	6.6 p	±0.1pF, ±0.25pF, ±0.5pF	532	200	0.2±0.02	R
TMK042 CH6R7□D-W			CH C0H	6.7 p	±0.1pF, ±0.25pF, ±0.5pF	534	200	0.2±0.02	R
TMK042 CH6R8□D-W			CH C0H	6.8 p	±0.1pF, ±0.25pF, ±0.5pF	536	200	0.2±0.02	R
TMK042 CH6R9□D-W			CH C0H	6.9 p	±0.1pF, ±0.25pF, ±0.5pF	538	200	0.2±0.02	R
TMK042 CH070□D-W			CH C0H	7 p	±0.1pF, ±0.25pF, ±0.5pF	540	200	0.2±0.02	R
TMK042 CH7R1□D-W			CH C0H	7.1 p	±0.1pF, ±0.25pF, ±0.5pF	542	200	0.2±0.02	R
TMK042 CH7R2□D-W			CH C0H	7.2 p	±0.1pF, ±0.25pF, ±0.5pF	544	200	0.2±0.02	R
TMK042 CH7R3□D-W			CH C0H	7.3 p	±0.1pF, ±0.25pF, ±0.5pF	546	200	0.2±0.02	R
TMK042 CH7R4□D-W			CH C0H	7.4 p	±0.1pF, ±0.25pF, ±0.5pF	548	200	0.2±0.02	R
TMK042 CH7R5□D-W			CH C0H	7.5 p	±0.1pF, ±0.25pF, ±0.5pF	550	200	0.2±0.02	R
TMK042 CH7R6□D-W			CH C0H	7.6 p	±0.1pF, ±0.25pF, ±0.5pF	552	200	0.2±0.02	R
TMK042 CH7R7□D-W			CH C0H	7.7 p	±0.1pF, ±0.25pF, ±0.5pF	554	200	0.2±0.02	R
TMK042 CH7R8□D-W			CH C0H	7.8 p	±0.1pF, ±0.25pF, ±0.5pF	556	200	0.2±0.02	R
TMK042 CH7R9□D-W			CH C0H	7.9 p	±0.1pF, ±0.25pF, ±0.5pF	558	200	0.2±0.02	R
TMK042 CH080□D-W			CH C0H	8 p	±0.1pF, ±0.25pF, ±0.5pF	560	200	0.2±0.02	R
TMK042 CH8R1□D-W			CH C0H	8.1 p	±0.1pF, ±0.25pF, ±0.5pF	562	200	0.2±0.02	R
TMK042 CH8R2□D-W			CH C0H	8.2 p	±0.1pF, ±0.25pF, ±0.5pF	564	200	0.2±0.02	R
TMK042 CH8R3□D-W			CH C0H	8.3 p	±0.1pF, ±0.25pF, ±0.5pF	566	200	0.2±0.02	R
TMK042 CH8R4□D-W			CH C0H	8.4 p	±0.1pF, ±0.25pF, ±0.5pF	568	200	0.2±0.02	R
TMK042 CH8R5□D-W			CH C0H	8.5 p	±0.1pF, ±0.25pF, ±0.5pF	570	200	0.2±0.02	R
TMK042 CH8R6□D-W			CH C0H	8.6 p	±0.1pF, ±0.25pF, ±0.5pF	572	200	0.2±0.02	R
TMK042 CH8R7□D-W			CH C0H	8.7 p	±0.1pF, ±0.25pF, ±0.5pF	574	200	0.2±0.02	R
TMK042 CH8R8□D-W			CH C0H	8.8 p	±0.1pF, ±0.25pF, ±0.5pF	576	200	0.2±0.02	R
TMK042 CH8R9□D-W			CH C0H	8.9 p	±0.1pF, ±0.25pF, ±0.5pF	578	200	0.2±0.02	R
TMK042 CH090□D-W			CH C0H	9 p	±0.1pF, ±0.25pF, ±0.5pF	580	200	0.2±0.02	R
TMK042 CH9R1□D-W			CH C0H	9.1 p	±0.1pF, ±0.25pF, ±0.5pF	582	200	0.2±0.02	R
TMK042 CH9R2□D-W			CH C0H	9.2 p	±0.1pF, ±0.25pF, ±0.5pF	584	200	0.2±0.02	R
TMK042 CH9R3□D-W			CH C0H	9.3 p	±0.1pF, ±0.25pF, ±0.5pF	586	200	0.2±0.02	R
TMK042 CH9R4□D-W			CH C0H	9.4 p	±0.1pF, ±0.25pF, ±0.5pF	588	200	0.2±0.02	R
TMK042 CH9R5□D-W			CH C0H	9.5 p	±0.1pF, ±0.25pF, ±0.5pF	590	200	0.2±0.02	R
TMK042 CH9R6□D-W			CH C0H	9.6 p	±0.1pF, ±0.25pF, ±0.5pF	592	200	0.2±0.02	R
TMK042 CH9R7□D-W			CH C0H	9.7 p	±0.1pF, ±0.25pF, ±0.5pF	594	200	0.2±0.02	R
TMK042 CH9R8□D-W			CH C0H	9.8 p	±0.1pF, ±0.25pF, ±0.5pF	596	200	0.2±0.02	R
TMK042 CH9R9□D-W			CH C0H	9.9 p	±0.1pF, ±0.25pF, ±0.5pF	598	200	0.2±0.02	R
TMK042 CH100DD-W			CH C0H	10 p	±0.5pF	600	200	0.2±0.02	R
TMK042 CH110JD-W			CH C0H	11 p	±5%	620	200	0.2±0.02	R
TMK042 CH120JD-W			CH C0H	12 p	±5%	640	200	0.2±0.02	R
TMK042 CH130JD-W			CH C0H	13 p	±5%	660	200	0.2±0.02	R
TMK042 CH150JD-W			CH C0H	15 p	±5%	700	200	0.2±0.02	R
TMK042 CH160JC-W		CH C0H	16 p	±5%	720	200	0.2±0.02	R	
TMK042 CH180JC-W		CH C0H	18 p	±5%	760	200	0.2±0.02	R	
TMK042 CH200JC-W		CH C0H	20 p	±5%	800	200	0.2±0.02	R	
TMK042 CH220JC-W		CH C0H	22 p	±5%	840	200	0.2±0.02	R	
TMK042 CH240JC-W		CH C0H	24 p	±5%	880	200	0.2±0.02	R	
TMK042 CH270JC-W		CH C0H	27 p	±5%	940	200	0.2±0.02	R	
TMK042 CH300JC-W		CH C0H	30 p	±5%	1000	200	0.2±0.02	R	
TMK042 CH330JC-W		CH C0H	33 p	±5%	1000	200	0.2±0.02	R	
TMK042 CH360JC-W		CH C0H	36 p	±5%	1000	200	0.2±0.02	R	
TMK042 CH390JC-W		CH C0H	39 p	±5%	1000	200	0.2±0.02	R	
TMK042 CH430JC-W		CH C0H	43 p	±5%	1000	200	0.2±0.02	R	
TMK042 CH470JC-W		CH C0H	47 p	±5%	1000	200	0.2±0.02	R	
TMK042 CH510JC-W		CH C0H	51 p	±5%	1000	200	0.2±0.02	R	
TMK042 CH560JC-W		CH C0H	56 p	±5%	1000	200	0.2±0.02	R	
TMK042 CH620JC-W		CH C0H	62 p	±5%	1000	200	0.2±0.02	R	
TMK042 CH680JC-W		CH C0H	68 p	±5%	1000	200	0.2±0.02	R	
TMK042 CH750JC-W		CH C0H	75 p	±5%	1000	200	0.2±0.02	R	
TMK042 CH820JC-W		CH C0H	82 p	±5%	1000	200	0.2±0.02	R	
TMK042 CH910JC-W		CH C0H	91 p	±5%	1000	200	0.2±0.02	R	
TMK042 CH101JC-W		CH C0H	100 p	±5%	1000	200	0.2±0.02	R	

[Temperature Characteristic CΔ : CΔ/C0Δ] 0.2mm thickness (C,D)

Part number 1	Part number 2	Rated voltage [V]	Temperature characteristics	Capacitance [F]	Capacitance tolerance [%]	Q (at 1MHz) min	HTLT	Thickness*3 [mm]	Soldering R:Reflow W:Wave
							Rated voltage x %		
EMK042 CK0R4□D-W		16	CK C0K	0.4 p	±0.05pF, ±0.1pF, ±0.25pF	408	200	0.2±0.02	R
EMK042 CK0R5□D-W			CK C0K	0.5 p	±0.05pF, ±0.1pF, ±0.25pF	410	200	0.2±0.02	R
EMK042 CK0R6□D-W			CK C0K	0.6 p	±0.05pF, ±0.1pF, ±0.25pF	412	200	0.2±0.02	R
EMK042 CK0R7□D-W			CK C0K	0.7 p	±0.05pF, ±0.1pF, ±0.25pF	414	200	0.2±0.02	R
EMK042 CKR75□D-W			CK C0K	0.75 p	±0.05pF, ±0.1pF, ±0.25pF	415	200	0.2±0.02	R
EMK042 CK0R8□D-W			CK C0K	0.8 p	±0.05pF, ±0.1pF, ±0.25pF	416	200	0.2±0.02	R
EMK042 CK0R9□D-W			CK C0K	0.9 p	±0.05pF, ±0.1pF, ±0.25pF	418	200	0.2±0.02	R
EMK042 CK010□D-W			CK C0K	1 p	±0.05pF, ±0.1pF, ±0.25pF	420	200	0.2±0.02	R
EMK042 CK1R1□D-W			CK C0K	1.1 p	±0.05pF, ±0.1pF, ±0.25pF	422	200	0.2±0.02	R
EMK042 CK1R2□D-W			CK C0K	1.2 p	±0.05pF, ±0.1pF, ±0.25pF	424	200	0.2±0.02	R
EMK042 CK1R3□D-W			CK C0K	1.3 p	±0.05pF, ±0.1pF, ±0.25pF	426	200	0.2±0.02	R
EMK042 CK1R4□D-W			CK C0K	1.4 p	±0.05pF, ±0.1pF, ±0.25pF	428	200	0.2±0.02	R
EMK042 CK1R5□D-W			CK C0K	1.5 p	±0.05pF, ±0.1pF, ±0.25pF	430	200	0.2±0.02	R
EMK042 CK1R6□D-W			CK C0K	1.6 p	±0.05pF, ±0.1pF, ±0.25pF	432	200	0.2±0.02	R
EMK042 CK1R7□D-W			CK C0K	1.7 p	±0.05pF, ±0.1pF, ±0.25pF	434	200	0.2±0.02	R

► This catalog contains the typical specification only due to the limitation of space. When you consider the purchase of our products, please check our specification. For details of each product (characteristics graph, reliability information, precautions for use, and so on), see our Web site (<http://www.ty-top.com/>).

PARTS NUMBER

Part number 1	Part number 2	Rated voltage [V]	Temperature characteristics	Capacitance [F]	Capacitance tolerance [%]	Q (at 1MHz) min	HTLT	Thickness*3 [mm]	Soldering R:Reflow W:Wave
							Rated voltage x %		
EMK042 CK1R8[D-W]		16	CK C0K	1.8 p	±0.05pF, ±0.1pF, ±0.25pF	436	200	0.2±0.02	R
EMK042 CK1R9[D-W]			CK C0K	1.9 p	±0.05pF, ±0.1pF, ±0.25pF	438	200	0.2±0.02	R
EMK042 CK020[D-W]			CK C0K	2 p	±0.05pF, ±0.1pF, ±0.25pF	440	200	0.2±0.02	R
EMK042 CK2R1[D-W]			CK C0K	2.1 p	±0.05pF, ±0.1pF, ±0.25pF	442	200	0.2±0.02	R
EMK042 CK2R2[D-W]			CK C0K	2.2 p	±0.05pF, ±0.1pF, ±0.25pF	444	200	0.2±0.02	R
EMK042 CK2R3[D-W]			CK C0K	2.3 p	±0.05pF, ±0.1pF, ±0.25pF	446	200	0.2±0.02	R
EMK042 CK2R4[D-W]			CK C0K	2.4 p	±0.05pF, ±0.1pF, ±0.25pF	448	200	0.2±0.02	R
EMK042 CK2R5[D-W]			CK C0K	2.5 p	±0.05pF, ±0.1pF, ±0.25pF	450	200	0.2±0.02	R
EMK042 CK2R6[D-W]			CK C0K	2.6 p	±0.05pF, ±0.1pF, ±0.25pF	452	200	0.2±0.02	R
EMK042 CK2R7[D-W]			CK C0K	2.7 p	±0.05pF, ±0.1pF, ±0.25pF	454	200	0.2±0.02	R
EMK042 CK2R8[D-W]			CK C0K	2.8 p	±0.05pF, ±0.1pF, ±0.25pF	456	200	0.2±0.02	R
EMK042 CK2R9[D-W]			CK C0K	2.9 p	±0.05pF, ±0.1pF, ±0.25pF	458	200	0.2±0.02	R
EMK042 CJ030[D-W]			CJ C0J	3 p	±0.05pF, ±0.1pF, ±0.25pF	460	200	0.2±0.02	R
EMK042 CJ3R1[D-W]			CJ C0J	3.1 p	±0.1pF, ±0.25pF	462	200	0.2±0.02	R
EMK042 CJ3R2[D-W]			CJ C0J	3.2 p	±0.1pF, ±0.25pF	464	200	0.2±0.02	R
EMK042 CJ3R3[D-W]			CJ C0J	3.3 p	±0.1pF, ±0.25pF	466	200	0.2±0.02	R
EMK042 CJ3R4[D-W]			CJ C0J	3.4 p	±0.1pF, ±0.25pF	468	200	0.2±0.02	R
EMK042 CJ3R5[D-W]			CJ C0J	3.5 p	±0.1pF, ±0.25pF	470	200	0.2±0.02	R
EMK042 CJ3R6[D-W]			CJ C0J	3.6 p	±0.1pF, ±0.25pF	472	200	0.2±0.02	R
EMK042 CJ3R7[D-W]			CJ C0J	3.7 p	±0.1pF, ±0.25pF	474	200	0.2±0.02	R
EMK042 CJ3R8[D-W]			CJ C0J	3.8 p	±0.1pF, ±0.25pF	476	200	0.2±0.02	R
EMK042 CJ3R9[D-W]			CJ C0J	3.9 p	±0.1pF, ±0.25pF	478	200	0.2±0.02	R
EMK042 CH040[D-W]			CH C0H	4 p	±0.1pF, ±0.25pF	480	200	0.2±0.02	R
EMK042 CH4R1[D-W]			CH C0H	4.1 p	±0.1pF, ±0.25pF	482	200	0.2±0.02	R
EMK042 CH4R2[D-W]			CH C0H	4.2 p	±0.1pF, ±0.25pF	484	200	0.2±0.02	R
EMK042 CH4R3[D-W]			CH C0H	4.3 p	±0.1pF, ±0.25pF	486	200	0.2±0.02	R
EMK042 CH4R4[D-W]			CH C0H	4.4 p	±0.1pF, ±0.25pF	488	200	0.2±0.02	R
EMK042 CH4R5[D-W]			CH C0H	4.5 p	±0.1pF, ±0.25pF	490	200	0.2±0.02	R
EMK042 CH4R6[D-W]			CH C0H	4.6 p	±0.1pF, ±0.25pF	492	200	0.2±0.02	R
EMK042 CH4R7[D-W]			CH C0H	4.7 p	±0.1pF, ±0.25pF	494	200	0.2±0.02	R
EMK042 CH4R8[D-W]			CH C0H	4.8 p	±0.1pF, ±0.25pF	496	200	0.2±0.02	R
EMK042 CH4R9[D-W]			CH C0H	4.9 p	±0.1pF, ±0.25pF	498	200	0.2±0.02	R
EMK042 CH050[D-W]			CH C0H	5 p	±0.1pF, ±0.25pF	500	200	0.2±0.02	R
EMK042 CH5R1[D-W]			CH C0H	5.1 p	±0.1pF, ±0.25pF, ±0.5pF	502	200	0.2±0.02	R
EMK042 CH5R2[D-W]			CH C0H	5.2 p	±0.1pF, ±0.25pF, ±0.5pF	504	200	0.2±0.02	R
EMK042 CH5R3[D-W]			CH C0H	5.3 p	±0.1pF, ±0.25pF, ±0.5pF	506	200	0.2±0.02	R
EMK042 CH5R4[D-W]			CH C0H	5.4 p	±0.1pF, ±0.25pF, ±0.5pF	508	200	0.2±0.02	R
EMK042 CH5R5[D-W]			CH C0H	5.5 p	±0.1pF, ±0.25pF, ±0.5pF	510	200	0.2±0.02	R
EMK042 CH5R6[D-W]			CH C0H	5.6 p	±0.1pF, ±0.25pF, ±0.5pF	512	200	0.2±0.02	R
EMK042 CH5R7[D-W]			CH C0H	5.7 p	±0.1pF, ±0.25pF, ±0.5pF	514	200	0.2±0.02	R
EMK042 CH5R8[D-W]			CH C0H	5.8 p	±0.1pF, ±0.25pF, ±0.5pF	516	200	0.2±0.02	R
EMK042 CH5R9[D-W]			CH C0H	5.9 p	±0.1pF, ±0.25pF, ±0.5pF	518	200	0.2±0.02	R
EMK042 CH060[D-W]			CH C0H	6 p	±0.1pF, ±0.25pF, ±0.5pF	520	200	0.2±0.02	R
EMK042 CH6R1[D-W]			CH C0H	6.1 p	±0.1pF, ±0.25pF, ±0.5pF	522	200	0.2±0.02	R
EMK042 CH6R2[D-W]			CH C0H	6.2 p	±0.1pF, ±0.25pF, ±0.5pF	524	200	0.2±0.02	R
EMK042 CH6R3[D-W]			CH C0H	6.3 p	±0.1pF, ±0.25pF, ±0.5pF	526	200	0.2±0.02	R
EMK042 CH6R4[D-W]			CH C0H	6.4 p	±0.1pF, ±0.25pF, ±0.5pF	528	200	0.2±0.02	R
EMK042 CH6R5[D-W]			CH C0H	6.5 p	±0.1pF, ±0.25pF, ±0.5pF	530	200	0.2±0.02	R
EMK042 CH6R6[D-W]			CH C0H	6.6 p	±0.1pF, ±0.25pF, ±0.5pF	532	200	0.2±0.02	R
EMK042 CH6R7[D-W]			CH C0H	6.7 p	±0.1pF, ±0.25pF, ±0.5pF	534	200	0.2±0.02	R
EMK042 CH6R8[D-W]			CH C0H	6.8 p	±0.1pF, ±0.25pF, ±0.5pF	536	200	0.2±0.02	R
EMK042 CH6R9[D-W]			CH C0H	6.9 p	±0.1pF, ±0.25pF, ±0.5pF	538	200	0.2±0.02	R
EMK042 CH070[D-W]			CH C0H	7 p	±0.1pF, ±0.25pF, ±0.5pF	540	200	0.2±0.02	R
EMK042 CH7R1[D-W]			CH C0H	7.1 p	±0.1pF, ±0.25pF, ±0.5pF	542	200	0.2±0.02	R
EMK042 CH7R2[D-W]			CH C0H	7.2 p	±0.1pF, ±0.25pF, ±0.5pF	544	200	0.2±0.02	R
EMK042 CH7R3[D-W]			CH C0H	7.3 p	±0.1pF, ±0.25pF, ±0.5pF	546	200	0.2±0.02	R
EMK042 CH7R4[D-W]			CH C0H	7.4 p	±0.1pF, ±0.25pF, ±0.5pF	548	200	0.2±0.02	R
EMK042 CH7R5[D-W]			CH C0H	7.5 p	±0.1pF, ±0.25pF, ±0.5pF	550	200	0.2±0.02	R
EMK042 CH7R6[D-W]			CH C0H	7.6 p	±0.1pF, ±0.25pF, ±0.5pF	552	200	0.2±0.02	R
EMK042 CH7R7[D-W]			CH C0H	7.7 p	±0.1pF, ±0.25pF, ±0.5pF	554	200	0.2±0.02	R
EMK042 CH7R8[D-W]			CH C0H	7.8 p	±0.1pF, ±0.25pF, ±0.5pF	556	200	0.2±0.02	R
EMK042 CH7R9[D-W]			CH C0H	7.9 p	±0.1pF, ±0.25pF, ±0.5pF	558	200	0.2±0.02	R
EMK042 CH080[D-W]			CH C0H	8 p	±0.1pF, ±0.25pF, ±0.5pF	560	200	0.2±0.02	R
EMK042 CH8R1[D-W]			CH C0H	8.1 p	±0.1pF, ±0.25pF, ±0.5pF	562	200	0.2±0.02	R
EMK042 CH8R2[D-W]			CH C0H	8.2 p	±0.1pF, ±0.25pF, ±0.5pF	564	200	0.2±0.02	R
EMK042 CH8R3[D-W]			CH C0H	8.3 p	±0.1pF, ±0.25pF, ±0.5pF	566	200	0.2±0.02	R
EMK042 CH8R4[D-W]			CH C0H	8.4 p	±0.1pF, ±0.25pF, ±0.5pF	568	200	0.2±0.02	R
EMK042 CH8R5[D-W]			CH C0H	8.5 p	±0.1pF, ±0.25pF, ±0.5pF	570	200	0.2±0.02	R
EMK042 CH8R6[D-W]			CH C0H	8.6 p	±0.1pF, ±0.25pF, ±0.5pF	572	200	0.2±0.02	R
EMK042 CH8R7[D-W]			CH C0H	8.7 p	±0.1pF, ±0.25pF, ±0.5pF	574	200	0.2±0.02	R
EMK042 CH8R8[D-W]			CH C0H	8.8 p	±0.1pF, ±0.25pF, ±0.5pF	576	200	0.2±0.02	R
EMK042 CH8R9[D-W]			CH C0H	8.9 p	±0.1pF, ±0.25pF, ±0.5pF	578	200	0.2±0.02	R
EMK042 CH090[D-W]			CH C0H	9 p	±0.1pF, ±0.25pF, ±0.5pF	580	200	0.2±0.02	R
EMK042 CH9R1[D-W]			CH C0H	9.1 p	±0.1pF, ±0.25pF, ±0.5pF	582	200	0.2±0.02	R
EMK042 CH9R2[D-W]			CH C0H	9.2 p	±0.1pF, ±0.25pF, ±0.5pF	584	200	0.2±0.02	R
EMK042 CH9R3[D-W]			CH C0H	9.3 p	±0.1pF, ±0.25pF, ±0.5pF	586	200	0.2±0.02	R
EMK042 CH9R4[D-W]			CH C0H	9.4 p	±0.1pF, ±0.25pF, ±0.5pF	588	200	0.2±0.02	R
EMK042 CH9R5[D-W]			CH C0H	9.5 p	±0.1pF, ±0.25pF, ±0.5pF	590	200	0.2±0.02	R
EMK042 CH9R6[D-W]			CH C0H	9.6 p	±0.1pF, ±0.25pF, ±0.5pF	592	200	0.2±0.02	R
EMK042 CH9R7[D-W]			CH C0H	9.7 p	±0.1pF, ±0.25pF, ±0.5pF	594	200	0.2±0.02	R
EMK042 CH9R8[D-W]			CH C0H	9.8 p	±0.1pF, ±0.25pF, ±0.5pF	596	200	0.2±0.02	R
EMK042 CH9R9[D-W]			CH C0H	9.9 p	±0.1pF, ±0.25pF, ±0.5pF	598	200	0.2±0.02	R
EMK042 CH100DD-W			CH C0H	10 p	±5pF	600	200	0.2±0.02	R
EMK042 CH110JD-W			CH C0H	11 p	±5%	620	200	0.2±0.02	R
EMK042 CH120JD-W			CH C0H	12 p	±5%	640	200	0.2±0.02	R
EMK042 CH130JD-W			CH C0H	13 p	±5%	660	200	0.2±0.02	R
EMK042 CH150JD-W			CH C0H	15 p	±5%	700	200	0.2±0.02	R
EMK042 CH160JC-W			CH C0H	16 p	±5%	720	200	0.2±0.02	R
EMK042 CH180JC-W			CH C0H	18 p	±5%	760	200	0.2±0.02	R
EMK042 CH200JC-W			CH C0H	20 p	±5%	800	200	0.2±0.02	R

CERAMIC CAPACITORS

▶ This catalog contains the typical specification only due to the limitation of space. When you consider the purchase of our products, please check our specification. For details of each product (characteristics graph, reliability information, precautions for use, and so on), see our Web site (<http://www.ty-top.com/>).

■ PARTS NUMBER

Part number 1	Part number 2	Rated voltage [V]	Temperature characteristics	Capacitance [F]	Capacitance tolerance [%]	Q (at 1MHz) min	HTLT	Thickness*3 [mm]	Soldering R:Reflow W:Wave
							Rated voltage x %		
EMK042 CH220JC-W		16	CH C0H	22 p	±5%	840	200	0.2±0.02	R
EMK042 CH240JC-W			CH C0H	24 p	±5%	880	200	0.2±0.02	R
EMK042 CH270JC-W			CH C0H	27 p	±5%	940	200	0.2±0.02	R
EMK042 CH300JC-W			CH C0H	30 p	±5%	1000	200	0.2±0.02	R
EMK042 CH330JC-W			CH C0H	33 p	±5%	1000	200	0.2±0.02	R
EMK042 CH360JC-W			CH C0H	36 p	±5%	1000	200	0.2±0.02	R
EMK042 CH390JC-W			CH C0H	39 p	±5%	1000	200	0.2±0.02	R
EMK042 CH430JC-W			CH C0H	43 p	±5%	1000	200	0.2±0.02	R
EMK042 CH470JC-W			CH C0H	47 p	±5%	1000	200	0.2±0.02	R
EMK042 CH510JC-W			CH C0H	51 p	±5%	1000	200	0.2±0.02	R
EMK042 CH560JC-W			CH C0H	56 p	±5%	1000	200	0.2±0.02	R
EMK042 CH620JC-W			CH C0H	62 p	±5%	1000	200	0.2±0.02	R
EMK042 CH680JC-W			CH C0H	68 p	±5%	1000	200	0.2±0.02	R
EMK042 CH750JC-W			CH C0H	75 p	±5%	1000	200	0.2±0.02	R
EMK042 CH820JC-W			CH C0H	82 p	±5%	1000	200	0.2±0.02	R
EMK042 CH910JC-W			CH C0H	91 p	±5%	1000	200	0.2±0.02	R
EMK042 CH101JC-W			CH C0H	100 p	±5%	1000	200	0.2±0.02	R

● 063TYPE

[Temperature Characteristic CG : CG/C0G] 0.3mm thickness(T)

Part number 1	Part number 2	Rated voltage [V]	Temperature characteristics	Capacitance [F]	Capacitance tolerance [%]	Q (at 1MHz) min	HTLT	Thickness*3 [mm]	Soldering R:Reflow W:Wave
							Rated voltage x %		
UMK063 CG0R2□T-F		50	CG C0G	0.2 p	±0.1pF, ±0.25pF	404	200	0.3±0.03	R
UMK063 CG0R3□T-F			CG C0G	0.3 p	±0.1pF, ±0.25pF	406	200	0.3±0.03	R
UMK063 CG0R4□T-F			CG C0G	0.4 p	±0.1pF, ±0.25pF	408	200	0.3±0.03	R
UMK063 CG0R5□T-F			CG C0G	0.5 p	±0.1pF, ±0.25pF	410	200	0.3±0.03	R
UMK063 CG0R6□T-F			CG C0G	0.6 p	±0.1pF, ±0.25pF	412	200	0.3±0.03	R
UMK063 CG0R7□T-F			CG C0G	0.7 p	±0.1pF, ±0.25pF	414	200	0.3±0.03	R
UMK063 CGR75□T-F			CG C0G	0.75 p	±0.1pF, ±0.25pF	415	200	0.3±0.03	R
UMK063 CG0R8□T-F			CG C0G	0.8 p	±0.1pF, ±0.25pF	416	200	0.3±0.03	R
UMK063 CG0R9□T-F			CG C0G	0.9 p	±0.1pF, ±0.25pF	418	200	0.3±0.03	R
UMK063 CG010□T-F			CG C0G	1 p	±0.1pF, ±0.25pF	420	200	0.3±0.03	R
UMK063 CG1R1□T-F			CG C0G	1.1 p	±0.1pF, ±0.25pF	422	200	0.3±0.03	R
UMK063 CG1R2□T-F			CG C0G	1.2 p	±0.1pF, ±0.25pF	424	200	0.3±0.03	R
UMK063 CG1R3□T-F			CG C0G	1.3 p	±0.1pF, ±0.25pF	426	200	0.3±0.03	R
UMK063 CG1R4□T-F			CG C0G	1.4 p	±0.1pF, ±0.25pF	428	200	0.3±0.03	R
UMK063 CG1R5□T-F			CG C0G	1.5 p	±0.1pF, ±0.25pF	430	200	0.3±0.03	R
UMK063 CG1R6□T-F			CG C0G	1.6 p	±0.1pF, ±0.25pF	432	200	0.3±0.03	R
UMK063 CG1R7□T-F			CG C0G	1.7 p	±0.1pF, ±0.25pF	434	200	0.3±0.03	R
UMK063 CG1R8□T-F			CG C0G	1.8 p	±0.1pF, ±0.25pF	436	200	0.3±0.03	R
UMK063 CG1R9□T-F			CG C0G	1.9 p	±0.1pF, ±0.25pF	438	200	0.3±0.03	R
UMK063 CG020□T-F			CG C0G	2 p	±0.1pF, ±0.25pF	440	200	0.3±0.03	R
UMK063 CG2R1□T-F			CG C0G	2.1 p	±0.1pF, ±0.25pF	442	200	0.3±0.03	R
UMK063 CG2R2□T-F			CG C0G	2.2 p	±0.1pF, ±0.25pF	444	200	0.3±0.03	R
UMK063 CG2R3□T-F			CG C0G	2.3 p	±0.1pF, ±0.25pF	446	200	0.3±0.03	R
UMK063 CG2R4□T-F			CG C0G	2.4 p	±0.1pF, ±0.25pF	448	200	0.3±0.03	R
UMK063 CG2R5□T-F			CG C0G	2.5 p	±0.1pF, ±0.25pF	450	200	0.3±0.03	R
UMK063 CG2R6□T-F			CG C0G	2.6 p	±0.1pF, ±0.25pF	452	200	0.3±0.03	R
UMK063 CG2R7□T-F			CG C0G	2.7 p	±0.1pF, ±0.25pF	454	200	0.3±0.03	R
UMK063 CG2R8□T-F			CG C0G	2.8 p	±0.1pF, ±0.25pF	456	200	0.3±0.03	R
UMK063 CG2R9□T-F			CG C0G	2.9 p	±0.1pF, ±0.25pF	458	200	0.3±0.03	R
UMK063 CG030□T-F			CG C0G	3 p	±0.1pF, ±0.25pF	460	200	0.3±0.03	R
UMK063 CG3R1□T-F			CG C0G	3.1 p	±0.1pF, ±0.25pF	462	200	0.3±0.03	R
UMK063 CG3R2□T-F			CG C0G	3.2 p	±0.1pF, ±0.25pF	464	200	0.3±0.03	R
UMK063 CG3R3□T-F			CG C0G	3.3 p	±0.1pF, ±0.25pF	466	200	0.3±0.03	R
UMK063 CG3R4□T-F			CG C0G	3.4 p	±0.1pF, ±0.25pF	468	200	0.3±0.03	R
UMK063 CG3R5□T-F			CG C0G	3.5 p	±0.1pF, ±0.25pF	470	200	0.3±0.03	R
UMK063 CG3R6□T-F			CG C0G	3.6 p	±0.1pF, ±0.25pF	472	200	0.3±0.03	R
UMK063 CG3R7□T-F			CG C0G	3.7 p	±0.1pF, ±0.25pF	474	200	0.3±0.03	R
UMK063 CG3R8□T-F			CG C0G	3.8 p	±0.1pF, ±0.25pF	476	200	0.3±0.03	R
UMK063 CG3R9□T-F			CG C0G	3.9 p	±0.1pF, ±0.25pF	478	200	0.3±0.03	R
UMK063 CG040□T-F			CG C0G	4 p	±0.1pF, ±0.25pF	480	200	0.3±0.03	R
UMK063 CG4R1□T-F			CG C0G	4.1 p	±0.1pF, ±0.25pF	482	200	0.3±0.03	R
UMK063 CG4R2□T-F			CG C0G	4.2 p	±0.1pF, ±0.25pF	484	200	0.3±0.03	R
UMK063 CG4R3□T-F			CG C0G	4.3 p	±0.1pF, ±0.25pF	486	200	0.3±0.03	R
UMK063 CG4R4□T-F			CG C0G	4.4 p	±0.1pF, ±0.25pF	488	200	0.3±0.03	R
UMK063 CG4R5□T-F			CG C0G	4.5 p	±0.1pF, ±0.25pF	490	200	0.3±0.03	R
UMK063 CG4R6□T-F			CG C0G	4.6 p	±0.1pF, ±0.25pF	492	200	0.3±0.03	R
UMK063 CG4R7□T-F			CG C0G	4.7 p	±0.1pF, ±0.25pF	494	200	0.3±0.03	R
UMK063 CG4R8□T-F			CG C0G	4.8 p	±0.1pF, ±0.25pF	496	200	0.3±0.03	R
UMK063 CG4R9□T-F			CG C0G	4.9 p	±0.1pF, ±0.25pF	498	200	0.3±0.03	R
UMK063 CG050□T-F			CG C0G	5 p	±0.1pF, ±0.25pF	500	200	0.3±0.03	R
UMK063 CG5R1□T-F		CG C0G	5.1 p	±0.1pF, ±0.25pF, ±0.5pF	502	200	0.3±0.03	R	
UMK063 CG5R2□T-F		CG C0G	5.2 p	±0.1pF, ±0.25pF, ±0.5pF	504	200	0.3±0.03	R	
UMK063 CG5R3□T-F		CG C0G	5.3 p	±0.1pF, ±0.25pF, ±0.5pF	506	200	0.3±0.03	R	
UMK063 CG5R4□T-F		CG C0G	5.4 p	±0.1pF, ±0.25pF, ±0.5pF	508	200	0.3±0.03	R	
UMK063 CG5R5□T-F		CG C0G	5.5 p	±0.1pF, ±0.25pF, ±0.5pF	510	200	0.3±0.03	R	
UMK063 CG5R6□T-F		CG C0G	5.6 p	±0.1pF, ±0.25pF, ±0.5pF	512	200	0.3±0.03	R	
UMK063 CG5R7□T-F		CG C0G	5.7 p	±0.1pF, ±0.25pF, ±0.5pF	514	200	0.3±0.03	R	
UMK063 CG5R8□T-F		CG C0G	5.8 p	±0.1pF, ±0.25pF, ±0.5pF	516	200	0.3±0.03	R	
UMK063 CG5R9□T-F		CG C0G	5.9 p	±0.1pF, ±0.25pF, ±0.5pF	518	200	0.3±0.03	R	
UMK063 CG060□T-F		CG C0G	6 p	±0.1pF, ±0.25pF, ±0.5pF	520	200	0.3±0.03	R	
UMK063 CG6R1□T-F		CG C0G	6.1 p	±0.1pF, ±0.25pF, ±0.5pF	522	200	0.3±0.03	R	
UMK063 CG6R2□T-F		CG C0G	6.2 p	±0.1pF, ±0.25pF, ±0.5pF	524	200	0.3±0.03	R	
UMK063 CG6R3□T-F		CG C0G	6.3 p	±0.1pF, ±0.25pF, ±0.5pF	526	200	0.3±0.03	R	
UMK063 CG6R4□T-F		CG C0G	6.4 p	±0.1pF, ±0.25pF, ±0.5pF	528	200	0.3±0.03	R	
UMK063 CG6R5□T-F		CG C0G	6.5 p	±0.1pF, ±0.25pF, ±0.5pF	530	200	0.3±0.03	R	
UMK063 CG6R6□T-F		CG C0G	6.6 p	±0.1pF, ±0.25pF, ±0.5pF	532	200	0.3±0.03	R	
UMK063 CG6R7□T-F		CG C0G	6.7 p	±0.1pF, ±0.25pF, ±0.5pF	534	200	0.3±0.03	R	

▶ This catalog contains the typical specification only due to the limitation of space. When you consider the purchase of our products, please check our specification. For details of each product (characteristics graph, reliability information, precautions for use, and so on), see our Web site (<http://www.ty-top.com/>).

PARTS NUMBER

Part number 1	Part number 2	Rated voltage [V]	Temperature characteristics	Capacitance [F]	Capacitance tolerance [%]	Q (at 1MHz) min	HTLT		Thickness*3 [mm]	Soldering R:Reflow W:Wave
							Rated voltage x %			
UMK063 CG6R8	T-F	50	CG C0G	6.8 p	±0.1pF, ±0.25pF, ±0.5pF	536	200		0.3±0.03	R
UMK063 CG6R9	T-F		CG C0G	6.9 p	±0.1pF, ±0.25pF, ±0.5pF	538	200		0.3±0.03	R
UMK063 CG070	T-F		CG C0G	7 p	±0.1pF, ±0.25pF, ±0.5pF	540	200		0.3±0.03	R
UMK063 CG7R1	T-F		CG C0G	7.1 p	±0.1pF, ±0.25pF, ±0.5pF	542	200		0.3±0.03	R
UMK063 CG7R2	T-F		CG C0G	7.2 p	±0.1pF, ±0.25pF, ±0.5pF	544	200		0.3±0.03	R
UMK063 CG7R3	T-F		CG C0G	7.3 p	±0.1pF, ±0.25pF, ±0.5pF	546	200		0.3±0.03	R
UMK063 CG7R4	T-F		CG C0G	7.4 p	±0.1pF, ±0.25pF, ±0.5pF	548	200		0.3±0.03	R
UMK063 CG7R5	T-F		CG C0G	7.5 p	±0.1pF, ±0.25pF, ±0.5pF	550	200		0.3±0.03	R
UMK063 CG7R6	T-F		CG C0G	7.6 p	±0.1pF, ±0.25pF, ±0.5pF	552	200		0.3±0.03	R
UMK063 CG7R7	T-F		CG C0G	7.7 p	±0.1pF, ±0.25pF, ±0.5pF	554	200		0.3±0.03	R
UMK063 CG7R8	T-F		CG C0G	7.8 p	±0.1pF, ±0.25pF, ±0.5pF	556	200		0.3±0.03	R
UMK063 CG7R9	T-F		CG C0G	7.9 p	±0.1pF, ±0.25pF, ±0.5pF	558	200		0.3±0.03	R
UMK063 CG080	T-F		CG C0G	8 p	±0.1pF, ±0.25pF, ±0.5pF	560	200		0.3±0.03	R
UMK063 CG8R1	T-F		CG C0G	8.1 p	±0.1pF, ±0.25pF, ±0.5pF	562	200		0.3±0.03	R
UMK063 CG8R2	T-F		CG C0G	8.2 p	±0.1pF, ±0.25pF, ±0.5pF	564	200		0.3±0.03	R
UMK063 CG8R3	T-F		CG C0G	8.3 p	±0.1pF, ±0.25pF, ±0.5pF	566	200		0.3±0.03	R
UMK063 CG8R4	T-F		CG C0G	8.4 p	±0.1pF, ±0.25pF, ±0.5pF	568	200		0.3±0.03	R
UMK063 CG8R5	T-F		CG C0G	8.5 p	±0.1pF, ±0.25pF, ±0.5pF	570	200		0.3±0.03	R
UMK063 CG8R6	T-F		CG C0G	8.6 p	±0.1pF, ±0.25pF, ±0.5pF	572	200		0.3±0.03	R
UMK063 CG8R7	T-F		CG C0G	8.7 p	±0.1pF, ±0.25pF, ±0.5pF	574	200		0.3±0.03	R
UMK063 CG8R8	T-F		CG C0G	8.8 p	±0.1pF, ±0.25pF, ±0.5pF	576	200		0.3±0.03	R
UMK063 CG8R9	T-F		CG C0G	8.9 p	±0.1pF, ±0.25pF, ±0.5pF	578	200		0.3±0.03	R
UMK063 CG090	T-F		CG C0G	9 p	±0.1pF, ±0.25pF, ±0.5pF	580	200		0.3±0.03	R
UMK063 CG9R1	T-F		CG C0G	9.1 p	±0.1pF, ±0.25pF, ±0.5pF	582	200		0.3±0.03	R
UMK063 CG9R2	T-F		CG C0G	9.2 p	±0.1pF, ±0.25pF, ±0.5pF	584	200		0.3±0.03	R
UMK063 CG9R3	T-F		CG C0G	9.3 p	±0.1pF, ±0.25pF, ±0.5pF	586	200		0.3±0.03	R
UMK063 CG9R4	T-F		CG C0G	9.4 p	±0.1pF, ±0.25pF, ±0.5pF	588	200		0.3±0.03	R
UMK063 CG9R5	T-F		CG C0G	9.5 p	±0.1pF, ±0.25pF, ±0.5pF	590	200		0.3±0.03	R
UMK063 CG9R6	T-F		CG C0G	9.6 p	±0.1pF, ±0.25pF, ±0.5pF	592	200		0.3±0.03	R
UMK063 CG9R7	T-F		CG C0G	9.7 p	±0.1pF, ±0.25pF, ±0.5pF	594	200		0.3±0.03	R
UMK063 CG9R8	T-F		CG C0G	9.8 p	±0.1pF, ±0.25pF, ±0.5pF	596	200		0.3±0.03	R
UMK063 CG9R9	T-F		CG C0G	9.9 p	±0.1pF, ±0.25pF, ±0.5pF	598	200		0.3±0.03	R
UMK063 CG100D	T-F		CG C0G	10 p	±5pF	600	200		0.3±0.03	R
UMK063 CG110J	T-F		CG C0G	11 p	±5%	620	200		0.3±0.03	R
UMK063 CG120J	T-F		CG C0G	12 p	±5%	640	200		0.3±0.03	R
UMK063 CG130J	T-F		CG C0G	13 p	±5%	660	200		0.3±0.03	R
UMK063 CG150J	T-F		CG C0G	15 p	±5%	700	200		0.3±0.03	R
UMK063 CG160J	T-F		CG C0G	16 p	±5%	720	200		0.3±0.03	R
UMK063 CG180J	T-F		CG C0G	18 p	±5%	760	200		0.3±0.03	R
UMK063 CG200J	T-F		CG C0G	20 p	±5%	800	200		0.3±0.03	R
UMK063 CG220J	T-F		CG C0G	22 p	±5%	840	200		0.3±0.03	R
UMK063 CG240J	T-F		CG C0G	24 p	±5%	880	200		0.3±0.03	R
UMK063 CG270J	T-F		CG C0G	27 p	±5%	940	200		0.3±0.03	R
UMK063 CG300J	T-F		CG C0G	30 p	±5%	1000	200		0.3±0.03	R
UMK063 CG330J	T-F		CG C0G	33 p	±5%	1000	200		0.3±0.03	R
UMK063 CG360J	T-F		CG C0G	36 p	±5%	1000	200		0.3±0.03	R
UMK063 CG390J	T-F		CG C0G	39 p	±5%	1000	200		0.3±0.03	R
UMK063 CG430J	T-F		CG C0G	43 p	±5%	1000	200		0.3±0.03	R
UMK063 CG470J	T-F		CG C0G	47 p	±5%	1000	200		0.3±0.03	R
UMK063 CG510J	T-F		CG C0G	51 p	±5%	1000	200		0.3±0.03	R
UMK063 CG560J	T-F		CG C0G	56 p	±5%	1000	200		0.3±0.03	R
UMK063 CG620J	T-F		CG C0G	62 p	±5%	1000	200		0.3±0.03	R
UMK063 CG680J	T-F		CG C0G	68 p	±5%	1000	200		0.3±0.03	R
UMK063 CG750J	T-F		CG C0G	75 p	±5%	1000	200		0.3±0.03	R
UMK063 CG820J	T-F		CG C0G	82 p	±5%	1000	200		0.3±0.03	R
UMK063 CG910J	T-F		CG C0G	91 p	±5%	1000	200		0.3±0.03	R
UMK063 CG101J	T-F		CG C0G	100 p	±5%	1000	200		0.3±0.03	R
UMK063 CG111J	T-F		CG C0G	110 p	±5%	1000	150		0.3±0.03	R
UMK063 CG121J	T-F		CG C0G	120 p	±5%	1000	150		0.3±0.03	R
UMK063 CG131J	T-F		CG C0G	130 p	±5%	1000	150		0.3±0.03	R
UMK063 CG151J	T-F		CG C0G	150 p	±5%	1000	150		0.3±0.03	R
UMK063 CG181J	T-F		CG C0G	180 p	±5%	1000	150		0.3±0.03	R
UMK063 CG201J	T-F	CG C0G	200 p	±5%	1000	150		0.3±0.03	R	
UMK063 CG221J	T-F	CG C0G	220 p	±5%	1000	150		0.3±0.03	R	

[Temperature Characteristic CΔ : CΔ/C0Δ] 0.3mm thickness (T)

Part number 1	Part number 2	Rated voltage [V]	Temperature characteristics	Capacitance [F]	Capacitance tolerance [%]	Q (at 1MHz) min	HTLT		Thickness*3 [mm]	Soldering R:Reflow W:Wave
							Rated voltage x %			
UMK063 CK0R2	T-F	50	CK C0K	0.2 p	±0.1pF, ±0.25pF	404	200		0.3±0.03	R
UMK063 CK0R3	T-F		CK C0K	0.3 p	±0.1pF, ±0.25pF	406	200		0.3±0.03	R
UMK063 CK0R4	T-F		CK C0K	0.4 p	±0.1pF, ±0.25pF	408	200		0.3±0.03	R
UMK063 CK0R5	T-F		CK C0K	0.5 p	±0.1pF, ±0.25pF	410	200		0.3±0.03	R
UMK063 CK0R6	T-F		CK C0K	0.6 p	±0.1pF, ±0.25pF	412	200		0.3±0.03	R
UMK063 CK0R7	T-F		CK C0K	0.7 p	±0.1pF, ±0.25pF	414	200		0.3±0.03	R
UMK063 CKR75	T-F		CK C0K	0.75 p	±0.1pF, ±0.25pF	415	200		0.3±0.03	R
UMK063 CK0R8	T-F		CK C0K	0.8 p	±0.1pF, ±0.25pF	416	200		0.3±0.03	R
UMK063 CK0R9	T-F		CK C0K	0.9 p	±0.1pF, ±0.25pF	418	200		0.3±0.03	R
UMK063 CK010	T-F		CK C0K	1 p	±0.1pF, ±0.25pF	420	200		0.3±0.03	R
UMK063 CK1R1	T-F		CK C0K	1.1 p	±0.1pF, ±0.25pF	422	200		0.3±0.03	R
UMK063 CK1R2	T-F		CK C0K	1.2 p	±0.1pF, ±0.25pF	424	200		0.3±0.03	R
UMK063 CK1R3	T-F		CK C0K	1.3 p	±0.1pF, ±0.25pF	426	200		0.3±0.03	R
UMK063 CK1R4	T-F		CK C0K	1.4 p	±0.1pF, ±0.25pF	428	200		0.3±0.03	R
UMK063 CK1R5	T-F		CK C0K	1.5 p	±0.1pF, ±0.25pF	430	200		0.3±0.03	R
UMK063 CK1R6	T-F		CK C0K	1.6 p	±0.1pF, ±0.25pF	432	200		0.3±0.03	R
UMK063 CK1R7	T-F		CK C0K	1.7 p	±0.1pF, ±0.25pF	434	200		0.3±0.03	R
UMK063 CK1R8	T-F		CK C0K	1.8 p	±0.1pF, ±0.25pF	436	200		0.3±0.03	R
UMK063 CK1R9	T-F		CK C0K	1.9 p	±0.1pF, ±0.25pF	438	200		0.3±0.03	R
UMK063 CK020	T-F		CK C0K	2 p	±0.1pF, ±0.25pF	440	200		0.3±0.03	R
UMK063 CK2R1	T-F		CK C0K	2.1 p	±0.1pF, ±0.25pF	442	200		0.3±0.03	R

▶ This catalog contains the typical specification only due to the limitation of space. When you consider the purchase of our products, please check our specification. For details of each product (characteristics graph, reliability information, precautions for use, and so on), see our Web site (<http://www.ty-top.com/>).

■ PARTS NUMBER

Part number 1	Part number 2	Rated voltage [V]	Temperature characteristics		Capacitance [F]	Capacitance tolerance [%]	Q (at 1MHz) min	HTLT	Thickness*3 [mm]	Soldering R:Reflow W:Wave
								Rated voltage x %		
UMK063	CH330JT-F	50	CH	C0H	33 p	±5%	1000	200	0.3±0.03	R
UMK063	CH360JT-F		CH	C0H	36 p	±5%	1000	200	0.3±0.03	R
UMK063	CH390JT-F		CH	C0H	39 p	±5%	1000	200	0.3±0.03	R
UMK063	CH430JT-F		CH	C0H	43 p	±5%	1000	200	0.3±0.03	R
UMK063	CH470JT-F		CH	C0H	47 p	±5%	1000	200	0.3±0.03	R
UMK063	CH510JT-F		CH	C0H	51 p	±5%	1000	200	0.3±0.03	R
UMK063	CH560JT-F		CH	C0H	56 p	±5%	1000	200	0.3±0.03	R
UMK063	CH620JT-F		CH	C0H	62 p	±5%	1000	200	0.3±0.03	R
UMK063	CH680JT-F		CH	C0H	68 p	±5%	1000	200	0.3±0.03	R
UMK063	CH750JT-F		CH	C0H	75 p	±5%	1000	200	0.3±0.03	R
UMK063	CH820JT-F		CH	C0H	82 p	±5%	1000	200	0.3±0.03	R
UMK063	CH910JT-F		CH	C0H	91 p	±5%	1000	200	0.3±0.03	R
UMK063	CH101JT-F		CH	C0H	100 p	±5%	1000	200	0.3±0.03	R
UMK063	CH111JT-F		CH	C0H	110 p	±5%	1000	150	0.3±0.03	R
UMK063	CH121JT-F		CH	C0H	120 p	±5%	1000	150	0.3±0.03	R
UMK063	CH131JT-F		CH	C0H	130 p	±5%	1000	150	0.3±0.03	R
UMK063	CH151JT-F		CH	C0H	150 p	±5%	1000	150	0.3±0.03	R
UMK063	CH181JT-F		CH	C0H	180 p	±5%	1000	150	0.3±0.03	R
UMK063	CH201JT-F		CH	C0H	200 p	±5%	1000	150	0.3±0.03	R
UMK063	CH221JT-F		CH	C0H	220 p	±5%	1000	150	0.3±0.03	R

● 105TYPE

【Temperature Characteristic CG : CG/C0G】 0.5mm thickness (V)

Part number 1	Part number 2	Rated voltage [V]	Temperature characteristics		Capacitance [F]	Capacitance tolerance [%]	Q (at 1MHz) min	HTLT	Thickness*3 [mm]	Soldering R:Reflow W:Wave
								Rated voltage x %		
UMK105	CG0R5CV-F	50	CG	C0G	0.5 p	±0.25pF	410	200	0.5±0.05	R
UMK105	CG010CV-F		CG	C0G	1 p	±0.25pF	420	200	0.5±0.05	R
UMK105	CG1R5CV-F		CG	C0G	1.5 p	±0.25pF	430	200	0.5±0.05	R
UMK105	CG020CV-F		CG	C0G	2 p	±0.25pF	440	200	0.5±0.05	R
UMK105	CG030CV-F		CG	C0G	3 p	±0.25pF	460	200	0.5±0.05	R
UMK105	CG040CV-F		CG	C0G	4 p	±0.25pF	480	200	0.5±0.05	R
UMK105	CG050CV-F		CG	C0G	5 p	±0.25pF	500	200	0.5±0.05	R
UMK105	CG060DV-F		CG	C0G	6 p	±0.5pF	520	200	0.5±0.05	R
UMK105	CG070DV-F		CG	C0G	7 p	±0.5pF	540	200	0.5±0.05	R
UMK105	CG080DV-F		CG	C0G	8 p	±0.5pF	560	200	0.5±0.05	R
UMK105	CG090DV-F		CG	C0G	9 p	±0.5pF	580	200	0.5±0.05	R
UMK105	CG100DV-F		CG	C0G	10 p	±0.5pF	600	200	0.5±0.05	R
UMK105	CG120JV-F		CG	C0G	12 p	±5%	640	200	0.5±0.05	R
UMK105	CG150JV-F		CG	C0G	15 p	±5%	700	200	0.5±0.05	R
UMK105	CG180JV-F		CG	C0G	18 p	±5%	760	200	0.5±0.05	R
UMK105	CG220JV-F		CG	C0G	22 p	±5%	840	200	0.5±0.05	R
UMK105	CG270JV-F		CG	C0G	27 p	±5%	940	200	0.5±0.05	R
UMK105	CG330JV-F		CG	C0G	33 p	±5%	1000	200	0.5±0.05	R
UMK105	CG390JV-F		CG	C0G	39 p	±5%	1000	200	0.5±0.05	R
UMK105	CG470JV-F		CG	C0G	47 p	±5%	1000	200	0.5±0.05	R
UMK105	CG560JV-F		CG	C0G	56 p	±5%	1000	200	0.5±0.05	R
UMK105	CG680JV-F		CG	C0G	68 p	±5%	1000	200	0.5±0.05	R
UMK105	CG820JV-F		CG	C0G	82 p	±5%	1000	200	0.5±0.05	R
UMK105	CG101JV-F		CG	C0G	100 p	±5%	1000	200	0.5±0.05	R
UMK105	CG121JV-F		CG	C0G	120 p	±5%	1000	200	0.5±0.05	R
UMK105	CG151JV-F		CG	C0G	150 p	±5%	1000	200	0.5±0.05	R
UMK105	CG181JV-F		CG	C0G	180 p	±5%	1000	200	0.5±0.05	R
UMK105	CG221JV-F		CG	C0G	220 p	±5%	1000	200	0.5±0.05	R
UMK105	CG271JV-F		CG	C0G	270 p	±5%	1000	200	0.5±0.05	R
UMK105	CG331JV-F		CG	C0G	330 p	±5%	1000	200	0.5±0.05	R
UMK105	CG361JV-F		CG	C0G	360 p	±5%	1000	200	0.5±0.05	R
UMK105	CG391JV-F		CG	C0G	390 p	±5%	1000	200	0.5±0.05	R
UMK105	CG431JV-F		CG	C0G	430 p	±5%	1000	200	0.5±0.05	R
UMK105	CG471JV-F		CG	C0G	470 p	±5%	1000	200	0.5±0.05	R
UMK105	CG511JV-F		CG	C0G	510 p	±5%	1000	200	0.5±0.05	R
UMK105	CG561JV-F		CG	C0G	560 p	±5%	1000	200	0.5±0.05	R
UMK105	CG621JV-F		CG	C0G	620 p	±5%	1000	200	0.5±0.05	R
UMK105	CG681JV-F		CG	C0G	680 p	±5%	1000	200	0.5±0.05	R
UMK105	CG751JV-F		CG	C0G	750 p	±5%	1000	200	0.5±0.05	R
UMK105	CG821JV-F		CG	C0G	820 p	±5%	1000	200	0.5±0.05	R
UMK105	CG102JV-F	CG	C0G	1000 p	±5%	1000	200	0.5±0.05	R	

【Temperature Characteristic CΔ : CΔ/C0Δ】 0.5mm thickness (V)

Part number 1	Part number 2	Rated voltage [V]	Temperature characteristics		Capacitance [F]	Capacitance tolerance [%]	Q (at 1MHz) min	HTLT	Thickness*3 [mm]	Soldering R:Reflow W:Wave
								Rated voltage x %		
UMK105	CK0R5CV-F	50	CK	C0K	0.5 p	±0.25pF	410	200	0.5±0.05	R
UMK105	CK010CV-F		CK	C0K	1 p	±0.25pF	420	200	0.5±0.05	R
UMK105	CK1R5CV-F		CK	C0K	1.5 p	±0.25pF	430	200	0.5±0.05	R
UMK105	CK020CV-F		CK	C0K	2 p	±0.25pF	440	200	0.5±0.05	R
UMK105	CJ030CV-F		CJ	C0J	3 p	±0.25pF	460	200	0.5±0.05	R
UMK105	CH040CV-F		CH	C0H	4 p	±0.25pF	480	200	0.5±0.05	R
UMK105	CH050CV-F		CH	C0H	5 p	±0.25pF	500	200	0.5±0.05	R
UMK105	CH060DV-F		CH	C0H	6 p	±0.5pF	520	200	0.5±0.05	R
UMK105	CH070DV-F		CH	C0H	7 p	±0.5pF	540	200	0.5±0.05	R
UMK105	CH080DV-F		CH	C0H	8 p	±0.5pF	560	200	0.5±0.05	R
UMK105	CH090DV-F		CH	C0H	9 p	±0.5pF	580	200	0.5±0.05	R
UMK105	CH100DV-F		CH	C0H	10 p	±0.5pF	600	200	0.5±0.05	R
UMK105	CH120JV-F		CH	C0H	12 p	±5%	640	200	0.5±0.05	R
UMK105	CH150JV-F		CH	C0H	15 p	±5%	700	200	0.5±0.05	R
UMK105	CH180JV-F		CH	C0H	18 p	±5%	760	200	0.5±0.05	R
UMK105	CH220JV-F		CH	C0H	22 p	±5%	840	200	0.5±0.05	R
UMK105	CH270JV-F		CH	C0H	27 p	±5%	940	200	0.5±0.05	R
UMK105	CH330JV-F		CH	C0H	33 p	±5%	1000	200	0.5±0.05	R

▶ This catalog contains the typical specification only due to the limitation of space. When you consider the purchase of our products, please check our specification. For details of each product (characteristics graph, reliability information, precautions for use, and so on), see our Web site (<http://www.ty-top.com/>).

■ PARTS NUMBER

Part number 1	Part number 2	Rated voltage [V]	Temperature characteristics		Capacitance [F]	Capacitance tolerance [%]	Q (at 1MHz) min	HTLT	Thickness*3 [mm]	Soldering R:Reflow W:Wave
								Rated voltage x %		
UMK105 CH390JV-F		50	CH	C0H	39 p	±5%	1000	200	0.5±0.05	R
UMK105 CH470JV-F			CH	C0H	47 p	±5%	1000	200	0.5±0.05	R
UMK105 CH560JV-F			CH	C0H	56 p	±5%	1000	200	0.5±0.05	R
UMK105 CH680JV-F			CH	C0H	68 p	±5%	1000	200	0.5±0.05	R
UMK105 CH820JV-F			CH	C0H	82 p	±5%	1000	200	0.5±0.05	R
UMK105 CH101JV-F			CH	C0H	100 p	±5%	1000	200	0.5±0.05	R
UMK105 CH121JV-F			CH	C0H	120 p	±5%	1000	200	0.5±0.05	R
UMK105 CH151JV-F			CH	C0H	150 p	±5%	1000	200	0.5±0.05	R
UMK105 CH181JV-F			CH	C0H	180 p	±5%	1000	200	0.5±0.05	R
UMK105 CH221JV-F			CH	C0H	220 p	±5%	1000	200	0.5±0.05	R
UMK105 CH271JV-F			CH	C0H	270 p	±5%	1000	200	0.5±0.05	R
UMK105 CH331JV-F			CH	C0H	330 p	±5%	1000	200	0.5±0.05	R
UMK105 CH361JV-F			CH	C0H	360 p	±5%	1000	200	0.5±0.05	R
UMK105 CH391JV-F			CH	C0H	390 p	±5%	1000	200	0.5±0.05	R
UMK105 CH431JV-F			CH	C0H	430 p	±5%	1000	200	0.5±0.05	R
UMK105 CH471JV-F			CH	C0H	470 p	±5%	1000	200	0.5±0.05	R
UMK105 CH511JV-F			CH	C0H	510 p	±5%	1000	200	0.5±0.05	R
UMK105 CH561JV-F			CH	C0H	560 p	±5%	1000	200	0.5±0.05	R
UMK105 CH621JV-F			CH	C0H	620 p	±5%	1000	200	0.5±0.05	R
UMK105 CH681JV-F			CH	C0H	680 p	±5%	1000	200	0.5±0.05	R
UMK105 CH751JV-F			CH	C0H	750 p	±5%	1000	200	0.5±0.05	R
UMK105 CH821JV-F			CH	C0H	820 p	±5%	1000	200	0.5±0.05	R
UMK105 CH102JV-F			CH	C0H	1000 p	±5%	1000	200	0.5±0.05	R

[Temperature Characteristic UΔ : UΔ/U2Δ] 0.5mm thickness (V)

Part number 1	Part number 2	Rated voltage [V]	Temperature characteristics		Capacitance [F]	Capacitance tolerance [%]	Q (at 1MHz) min	HTLT	Thickness*3 [mm]	Soldering R:Reflow W:Wave
								Rated voltage x %		
UMK105 UK0R5CV-F		50	UK	U2K	0.5 p	±0.25pF	410	200	0.5±0.05	R
UMK105 UK010CV-F			UK	U2K	1 p	±0.25pF	420	200	0.5±0.05	R
UMK105 UK1R5CV-F			UK	U2K	1.5 p	±0.25pF	430	200	0.5±0.05	R
UMK105 UK020CV-F			UK	U2K	2 p	±0.25pF	440	200	0.5±0.05	R
UMK105 UK030CV-F			UK	U2K	3 p	±0.25pF	460	200	0.5±0.05	R
UMK105 UJ040CV-F			UJ	U2J	4 p	±0.25pF	480	200	0.5±0.05	R
UMK105 UJ050CV-F			UJ	U2J	5 p	±0.25pF	500	200	0.5±0.05	R
UMK105 UJ060DV-F			UJ	U2J	6 p	±0.5pF	520	200	0.5±0.05	R
UMK105 UJ070DV-F			UJ	U2J	7 p	±0.5pF	540	200	0.5±0.05	R
UMK105 UJ080DV-F			UJ	U2J	8 p	±0.5pF	560	200	0.5±0.05	R
UMK105 UJ090DV-F			UJ	U2J	9 p	±0.5pF	580	200	0.5±0.05	R
UMK105 UJ100DV-F			UJ	U2J	10 p	±0.5pF	600	200	0.5±0.05	R
UMK105 UJ120JV-F			UJ	U2J	12 p	±5%	640	200	0.5±0.05	R
UMK105 UJ150JV-F			UJ	U2J	15 p	±5%	700	200	0.5±0.05	R
UMK105 UJ180JV-F			UJ	U2J	18 p	±5%	760	200	0.5±0.05	R
UMK105 UJ220JV-F			UJ	U2J	22 p	±5%	840	200	0.5±0.05	R
UMK105 UJ270JV-F			UJ	U2J	27 p	±5%	940	200	0.5±0.05	R
UMK105 UJ330JV-F			UJ	U2J	33 p	±5%	1000	200	0.5±0.05	R
UMK105 UJ390JV-F			UJ	U2J	39 p	±5%	1000	200	0.5±0.05	R
UMK105 UJ470JV-F			UJ	U2J	47 p	±5%	1000	200	0.5±0.05	R
UMK105 UJ560JV-F			UJ	U2J	56 p	±5%	1000	200	0.5±0.05	R
UMK105 UJ680JV-F			UJ	U2J	68 p	±5%	1000	200	0.5±0.05	R
UMK105 UJ820JV-F			UJ	U2J	82 p	±5%	1000	200	0.5±0.05	R
UMK105 UJ101JV-F			UJ	U2J	100 p	±5%	1000	200	0.5±0.05	R
UMK105 UJ121JV-F			UJ	U2J	120 p	±5%	1000	200	0.5±0.05	R
UMK105 UJ151JV-F			UJ	U2J	150 p	±5%	1000	200	0.5±0.05	R
UMK105 UJ181JV-F			UJ	U2J	180 p	±5%	1000	200	0.5±0.05	R
UMK105 UJ221JV-F			UJ	U2J	220 p	±5%	1000	200	0.5±0.05	R
UMK105 UJ271JV-F			UJ	U2J	270 p	±5%	1000	200	0.5±0.05	R
UMK105 UJ331JV-F			UJ	U2J	330 p	±5%	1000	200	0.5±0.05	R

[Temperature Characteristic SL] 0.5mm thickness (V)

Part number 1	Part number 2	Rated voltage [V]	Temperature characteristics		Capacitance [F]	Capacitance tolerance [%]	Q (at 1MHz) min	HTLT	Thickness*3 [mm]	Soldering R:Reflow W:Wave
								Rated voltage x %		
UMK105 SL121JV-F		50	SL		120 p	±5%	1000	200	0.5±0.05	R
UMK105 SL151JV-F			SL		150 p	±5%	1000	200	0.5±0.05	R
UMK105 SL181JV-F			SL		180 p	±5%	1000	200	0.5±0.05	R
UMK105 SL221JV-F			SL		220 p	±5%	1000	200	0.5±0.05	R
UMK105 SL271JV-F			SL		270 p	±5%	1000	200	0.5±0.05	R
UMK105 SL331JV-F			SL		330 p	±5%	1000	200	0.5±0.05	R

Multilayer Ceramic Capacitors for High Frequency Applications (1GHz+)

● 042TYPE

[Temperature Characteristic CH : CH/COH] 0.2mm thickness (C)

Part number 1	Part number 2	Rated voltage [V]	Temperature characteristics		Capacitance [F]	Capacitance tolerance [%]	Q (at 1GHz) (min)	HTLT	Thickness*3 [mm]	Soldering R:Reflow W:Wave
								Rated voltage x %		
TVS042 CH0R2□C-W		25	CH	C0H	0.2 p	±0.05pF, ±0.1pF, ±0.25pF	300	200	0.2±0.02	R
TVS042 CH0R3□C-W			CH	C0H	0.3 p	±0.05pF, ±0.1pF, ±0.25pF	300	200	0.2±0.02	R
TVS042 CH0R4□C-W			CH	C0H	0.4 p	±0.05pF, ±0.1pF, ±0.25pF	300	200	0.2±0.02	R
TVS042 CH0R5□C-W			CH	C0H	0.5 p	±0.05pF, ±0.1pF, ±0.25pF	300	200	0.2±0.02	R
TVS042 CH0R6□C-W			CH	C0H	0.6 p	±0.05pF, ±0.1pF, ±0.25pF	300	200	0.2±0.02	R
TVS042 CH0R7□C-W			CH	C0H	0.7 p	±0.05pF, ±0.1pF, ±0.25pF	300	200	0.2±0.02	R
TVS042 CHR75□C-W			CH	C0H	0.75 p	±0.05pF, ±0.1pF, ±0.25pF	300	200	0.2±0.02	R
TVS042 CH0R8□C-W			CH	C0H	0.8 p	±0.05pF, ±0.1pF, ±0.25pF	300	200	0.2±0.02	R
TVS042 CH0R9□C-W			CH	C0H	0.9 p	±0.05pF, ±0.1pF, ±0.25pF	300	200	0.2±0.02	R
TVS042 CH010□C-W			CH	C0H	1 p	±0.05pF, ±0.1pF, ±0.25pF	300	200	0.2±0.02	R
TVS042 CH1R1□C-W			CH	C0H	1.1 p	±0.05pF, ±0.1pF, ±0.25pF	280	200	0.2±0.02	R
TVS042 CH1R2□C-W			CH	C0H	1.2 p	±0.05pF, ±0.1pF, ±0.25pF	270	200	0.2±0.02	R
TVS042 CH1R3□C-W			CH	C0H	1.3 p	±0.05pF, ±0.1pF, ±0.25pF	260	200	0.2±0.02	R

▶ This catalog contains the typical specification only due to the limitation of space. When you consider the purchase of our products, please check our specification. For details of each product (characteristics graph, reliability information, precautions for use, and so on), see our Web site (<http://www.ty-top.com/>).

■ PARTS NUMBER

Part number 1	Part number 2	Rated voltage [V]	Temperature characteristics		Capacitance [F]	Capacitance tolerance [%]	Q (at 1GHz) (min)	HTLT	Thickness*3 [mm]	Soldering R:Reflow W:Wave
								Rated voltage x %		
TVS042 CH150JC-W		25	CH	C0H	15 p	±5%	40	200	0.2±0.02	R
TVS042 CH160JC-W			CH	C0H	16 p	±5%	40	200	0.2±0.02	R
TVS042 CH180JC-W			CH	C0H	18 p	±5%	40	200	0.2±0.02	R
TVS042 CH220JC-W			CH	C0H	22 p	±5%	30	200	0.2±0.02	R

● 105TYPE

[Temperature Characteristic CH : CH/C0H] 0.5mm thickness (W)

Part number 1	Part number 2	Rated voltage [V]	Temperature characteristics		Capacitance [F]	Capacitance tolerance [%]	Q (at 1GHz) (min)	HTLT	Thickness*3 [mm]	Soldering R:Reflow W:Wave
								Rated voltage x %		
EVK105 CH0R3BW-F		16	CH	C0H	0.3 p	±0.1pF	300	200	0.5±0.05	R
EVK105 CH0R4BW-F			CH	C0H	0.4 p	±0.1pF	300	200	0.5±0.05	R
EVK105 CH0R5BW-F			CH	C0H	0.5 p	±0.1pF	300	200	0.5±0.05	R
EVK105 CH0R6BW-F			CH	C0H	0.6 p	±0.1pF	300	200	0.5±0.05	R
EVK105 CH0R7BW-F			CH	C0H	0.7 p	±0.1pF	300	200	0.5±0.05	R
EVK105 CH0R8BW-F			CH	C0H	0.8 p	±0.1pF	300	200	0.5±0.05	R
EVK105 CH0R9BW-F			CH	C0H	0.9 p	±0.1pF	300	200	0.5±0.05	R
EVK105 CH010BW-F			CH	C0H	1 p	±0.1pF	300	200	0.5±0.05	R
EVK105 CH1R1BW-F			CH	C0H	1.1 p	±0.1pF	280	200	0.5±0.05	R
EVK105 CH1R2BW-F			CH	C0H	1.2 p	±0.1pF	270	200	0.5±0.05	R
EVK105 CH1R3BW-F			CH	C0H	1.3 p	±0.1pF	260	200	0.5±0.05	R
EVK105 CH1R5BW-F			CH	C0H	1.5 p	±0.1pF	240	200	0.5±0.05	R
EVK105 CH1R6BW-F			CH	C0H	1.6 p	±0.1pF	230	200	0.5±0.05	R
EVK105 CH1R8BW-F			CH	C0H	1.8 p	±0.1pF	210	200	0.5±0.05	R
EVK105 CH020BW-F			CH	C0H	2 p	±0.1pF	190	200	0.5±0.05	R
EVK105 CH2R2JW-F			CH	C0H	2.2 p	±5%	180	200	0.5±0.05	R
EVK105 CH2R4JW-F			CH	C0H	2.4 p	±5%	170	200	0.5±0.05	R
EVK105 CH2R7JW-F			CH	C0H	2.7 p	±5%	150	200	0.5±0.05	R
EVK105 CH030JW-F			CH	C0H	3 p	±5%	130	200	0.5±0.05	R
EVK105 CH3R3JW-F			CH	C0H	3.3 p	±5%	120	200	0.5±0.05	R
EVK105 CH3R6JW-F			CH	C0H	3.6 p	±5%	110	200	0.5±0.05	R
EVK105 CH3R9JW-F			CH	C0H	3.9 p	±5%	99	200	0.5±0.05	R
EVK105 CH4R3JW-F			CH	C0H	4.3 p	±5%	84	200	0.5±0.05	R
EVK105 CH4R7JW-F			CH	C0H	4.7 p	±5%	84	200	0.5±0.05	R
EVK105 CH5R1JW-F			CH	C0H	5.1 p	±5%	84	200	0.5±0.05	R

[Temperature Characteristic CH : CH/C0H] 0.5mm thickness (W)

Part number 1	Part number 2	Rated voltage [V]	Temperature characteristics		Capacitance [F]	Capacitance tolerance [%]	Q (at 1GHz) (min)	HTLT	Thickness*3 [mm]	Soldering R:Reflow W:Wave
								Rated voltage x %		
UVK105 CH0R3BW-F		50	CH	C0H	0.3 p	±0.1pF	300	200	0.5±0.05	R
UVK105 CH0R4BW-F			CH	C0H	0.4 p	±0.1pF	300	200	0.5±0.05	R
UVK105 CH0R5BW-F			CH	C0H	0.5 p	±0.1pF	300	200	0.5±0.05	R
UVK105 CH0R6BW-F			CH	C0H	0.6 p	±0.1pF	300	200	0.5±0.05	R
UVK105 CH0R7BW-F			CH	C0H	0.7 p	±0.1pF	300	200	0.5±0.05	R
UVK105 CH0R8BW-F			CH	C0H	0.8 p	±0.1pF	300	200	0.5±0.05	R
UVK105 CH0R9BW-F			CH	C0H	0.9 p	±0.1pF	300	200	0.5±0.05	R
UVK105 CH010BW-F			CH	C0H	1 p	±0.1pF	300	200	0.5±0.05	R
UVK105 CH1R1BW-F			CH	C0H	1.1 p	±0.1pF	280	200	0.5±0.05	R
UVK105 CH1R2BW-F			CH	C0H	1.2 p	±0.1pF	270	200	0.5±0.05	R
UVK105 CH1R3BW-F			CH	C0H	1.3 p	±0.1pF	260	200	0.5±0.05	R
UVK105 CH1R5BW-F			CH	C0H	1.5 p	±0.1pF	240	200	0.5±0.05	R
UVK105 CH1R6BW-F			CH	C0H	1.6 p	±0.1pF	230	200	0.5±0.05	R
UVK105 CH1R8BW-F			CH	C0H	1.8 p	±0.1pF	210	200	0.5±0.05	R
UVK105 CH020BW-F			CH	C0H	2 p	±0.1pF	190	200	0.5±0.05	R
UVK105 CH2R2JW-F			CH	C0H	2.2 p	±5%	180	200	0.5±0.05	R
UVK105 CH2R4JW-F			CH	C0H	2.4 p	±5%	170	200	0.5±0.05	R
UVK105 CH2R7JW-F			CH	C0H	2.7 p	±5%	150	200	0.5±0.05	R
UVK105 CH030JW-F			CH	C0H	3 p	±5%	130	200	0.5±0.05	R
UVK105 CH3R3JW-F			CH	C0H	3.3 p	±5%	120	200	0.5±0.05	R
UVK105 CH3R6JW-F			CH	C0H	3.6 p	±5%	110	200	0.5±0.05	R
UVK105 CH3R9JW-F			CH	C0H	3.9 p	±5%	99	200	0.5±0.05	R
UVK105 CH4R3JW-F			CH	C0H	4.3 p	±5%	84	200	0.5±0.05	R
UVK105 CH4R7JW-F			CH	C0H	4.7 p	±5%	84	200	0.5±0.05	R
UVK105 CH5R1JW-F			CH	C0H	5.1 p	±5%	84	200	0.5±0.05	R

Super Low Distortion Multilayer Ceramic Capacitors (CFCAP™)

● 105TYPE

[Temperature Characteristic SD : Standard] 0.5mm thickness (V)

Part number 1	Part number 2	Rated voltage [V]	Temperature characteristics	Capacitance [F]	Capacitance tolerance [%]	tan δ [%]	HTLT	Thickness*3 [mm]	Soldering R:Reflow W:Wave
							Rated voltage x %		
UMK105 SD391KV-F		50	Standard Type	390 p	±10	0.1	200	0.5±0.05	R
UMK105 SD471KV-F				470 p	±10	0.1	200	0.5±0.05	R
UMK105 SD561KV-F				560 p	±10	0.1	200	0.5±0.05	R
TMK105 SD681KV-F		25		680 p	±10	0.1	200	0.5±0.05	R
TMK105 SD821KV-F				820 p	±10	0.1	200	0.5±0.05	R
TMK105 SD102KV-F				1000 p	±10	0.1	200	0.5±0.05	R
TMK105 SD122KV-F		16		1200 p	±10	0.1	200	0.5±0.05	R
EMK105 SD152KV-F				1500 p	±10	0.1	200	0.5±0.05	R
EMK105 SD182KV-F				1800 p	±10	0.1	200	0.5±0.05	R
EMK105 SD222KV-F		10		2200 p	±10	0.1	200	0.5±0.05	R
EMK105 SD272KV-F				2700 p	±10	0.1	200	0.5±0.05	R
LMK105 SD332KV-F				3300 p	±10	0.1	200	0.5±0.05	R
LMK105 SD392KV-F		10	3900 p	±10	0.1	200	0.5±0.05	R	
LMK105 SD472KV-F			4700 p	±10	0.1	200	0.5±0.05	R	

▶ This catalog contains the typical specification only due to the limitation of space. When you consider the purchase of our products, please check our specification. For details of each product (characteristics graph, reliability information, precautions for use, and so on), see our Web site (<http://www.ty-top.com/>).

■ PARTS NUMBER

【Temperature Characteristic SD : Standard】 0.3mm thickness (P)

Part number 1	Part number 2	Rated voltage [V]	Temperature characteristics	Capacitance [F]	Capacitance tolerance [%]	tan δ [%]	HTLT		Soldering R:Reflow W:Wave
							Rated voltage x %	Thickness* ³ [mm]	
LMK105 SD152KP-F		10	Standard Type	1500 p	±10	0.1	200	0.3±0.03	R
JMK105 SD272KP-F		6.3		2700 p	±10	0.1	200	0.3±0.03	R

● 107TYPE

【Temperature Characteristic SD : Standard】 0.8mm thickness (A)

Part number 1	Part number 2	Rated voltage [V]	Temperature characteristics	Capacitance [F]	Capacitance tolerance [%]	tan δ [%]	HTLT		Soldering R:Reflow W:Wave	
							Rated voltage x %	Thickness* ³ [mm]		
UMK107 SD102KA-T		50	Standard Type	1000 p	±10	0.1	200	0.8±0.10	R	
UMK107 SD122KA-T				1200 p	±10	0.1	200	0.8±0.10	R	
UMK107 SD152KA-T				1500 p	±10	0.1	200	0.8±0.10	R	
UMK107 SD182KA-T				1800 p	±10	0.1	200	0.8±0.10	R	
UMK107 SD222KA-T				2200 p	±10	0.1	200	0.8±0.10	R	
UMK107 SD272KA-T				2700 p	±10	0.1	200	0.8±0.10	R	
UMK107 SD332KA-T				3300 p	±10	0.1	200	0.8±0.10	R	
TMK107 SD392KA-T				25	3900 p	±10	0.1	200	0.8±0.10	R
TMK107 SD472KA-T					4700 p	±10	0.1	200	0.8±0.10	R
EMK107 SD562KA-T					16	5600 p	±10	0.1	200	0.8±0.10
EMK107 SD682KA-T		6800 p	±10			0.1	200	0.8±0.10	R	
EMK107 SD822KA-T		8200 p	±10	0.1		200	0.8±0.10	R		
EMK107 SD103KA-T		10	0.01 μ	±10		0.1	200	0.8±0.10	R	
LMK107 SD123KA-T			0.012 μ	±10		0.1	200	0.8±0.10	R	
LMK107 SD153KA-T			0.015 μ	±10		0.1	200	0.8±0.10	R	
LMK107 SD183KA-T			0.018 μ	±10	0.1	200	0.8±0.10	R		
LMK107 SD223KA-T			0.022 μ	±10	0.1	200	0.8±0.10	R		

● 212TYPE

【Temperature Characteristic SD : Standard】 1.25mm thickness (G)

Part number 1	Part number 2	Rated voltage [V]	Temperature characteristics	Capacitance [F]	Capacitance tolerance [%]	tan δ [%]	HTLT		Soldering R:Reflow W:Wave
							Rated voltage x %	Thickness* ³ [mm]	
GMK212 SD183KG-T		35	Standard Type	0.018 μ	±10	0.1	200	1.25±0.10	R
GMK212 SD223KG-T				0.022 μ	±10	0.1	200	1.25±0.10	R
GMK212 SD273KG-T				0.027 μ	±10	0.1	200	1.25±0.10	R
LMK212 SD683KG-T				10	0.068 μ	±10	0.1	200	1.25±0.10
LMK212 SD823KG-T		0.082 μ	±10		0.1	200	1.25±0.10	R	
LMK212 SD104KG-T		0.1 μ	±10		0.1	200	1.25±0.10	R	

【Temperature Characteristic SD : Standard】 0.85mm thickness (D)

Part number 1	Part number 2	Rated voltage [V]	Temperature characteristics	Capacitance [F]	Capacitance tolerance [%]	tan δ [%]	HTLT		Soldering R:Reflow W:Wave
							Rated voltage x %	Thickness* ³ [mm]	
UMK212 SD392KD-T		50	Standard Type	3900 p	±10	0.1	200	0.85±0.10	R
UMK212 SD472KD-T				4700 p	±10	0.1	200	0.85±0.10	R
UMK212 SD562KD-T				5600 p	±10	0.1	200	0.85±0.10	R
UMK212 SD682KD-T				6800 p	±10	0.1	200	0.85±0.10	R
UMK212 SD822KD-T				8200 p	±10	0.1	200	0.85±0.10	R
UMK212 SD103KD-T				35	0.01 μ	±10	0.1	200	0.85±0.10
GMK212 SD123KD-T		0.012 μ	±10		0.1	200	0.85±0.10	R	
GMK212 SD153KD-T		0.015 μ	±10		0.1	200	0.85±0.10	R	
EMK212 SD333KD-T		16	0.033 μ		±10	0.1	200	0.85±0.10	R
LMK212 SD473KD-T			0.047 μ	±10	0.1	200	0.85±0.10	R	

● 316TYPE

【Temperature Characteristic SD : Standard】 1.6mm thickness (L)

Part number 1	Part number 2	Rated voltage [V]	Temperature characteristics	Capacitance [F]	Capacitance tolerance [%]	tan δ [%]	HTLT		Soldering R:Reflow W:Wave
							Rated voltage x %	Thickness* ³ [mm]	
TMK316 SD823KL-T		25	Standard Type	0.082 μ	±10	0.1	200	1.6±0.20	R
TMK316 SD104KL-T				0.1 μ	±10	0.1	200	1.6±0.20	R

【Temperature Characteristic SD : Standard】 1.15mm thickness (F)

Part number 1	Part number 2	Rated voltage [V]	Temperature characteristics	Capacitance [F]	Capacitance tolerance [%]	tan δ [%]	HTLT		Soldering R:Reflow W:Wave
							Rated voltage x %	Thickness* ³ [mm]	
GMK316 SD333KF-T		35	Standard Type	0.033 μ	±10	0.1	200	1.15±0.10	R
GMK316 SD393KF-T				0.039 μ	±10	0.1	200	1.15±0.10	R
TMK316 SD473KF-T		25	Standard Type	0.047 μ	±10	0.1	200	1.15±0.10	R
TMK316 SD563KF-T				0.056 μ	±10	0.1	200	1.15±0.10	R
TMK316 SD683KF-T				0.068 μ	±10	0.1	200	1.15±0.10	R

Low Distortion High Value Multilayer Ceramic Capacitors(OFLD)

● 107TYPE

【Temperature Characteristic LD : X5R】 0.8mm thickness (A)

Part number 1	Part number 2	Rated voltage [V]	Temperature characteristics	Capacitance [F]	Capacitance tolerance [%]	tan δ [%]	HTLT		Soldering R:Reflow W:Wave
							Rated voltage x %	Thickness* ³ [mm]	
UMK107BLD224[A]-T		50	X5R	0.22 μ	±10, ±20	10	150	0.8+0.20/-0	R
TMK107BLD474[A]-T				X5R	0.47 μ	±10, ±20	10	150	0.8+0.20/-0
TMK107BLD105[A]-T		25	X5R	1 μ	±10, ±20	10	150	0.8+0.20/-0	R

● 212TYPE

【Temperature Characteristic LD : X5R】 1.25mm thickness (G)

Part number 1	Part number 2	Rated voltage [V]	Temperature characteristics	Capacitance [F]	Capacitance tolerance [%]	tan δ [%]	HTLT		Soldering R:Reflow W:Wave
							Rated voltage x %	Thickness* ³ [mm]	
GMK212 LD105[G]-T		35	X5R	1 μ	±10, ±20	10	150	1.25±0.10	R
GMK212BLD225[G]-T				X5R	2.2 μ	±10, ±20	10	150	1.25+0.20/-0

▶ This catalog contains the typical specification only due to the limitation of space. When you consider the purchase of our products, please check our specification. For details of each product (characteristics graph, reliability information, precautions for use, and so on), see our Web site (<http://www.ty-top.com/>).

■ PARTS NUMBER

● 316TYPE

[Temperature Characteristic LD : X5R] 1.6mm thickness (L)

Part number 1	Part number 2	Rated voltage [V]	Temperature characteristics		Capacitance [F]	Capacitance tolerance [%]	tan δ [%]	HTLT	Thickness*3 [mm]	Soldering R:Reflow W:Wave
								Rated voltage x %		
UMK316 LD105□L-T		50		X5R	1 μ	±10, ±20	10	150	1.6±0.20	R
GMK316BLD475□L-T		35		X5R	4.7 μ	±10, ±20	10	150	1.6±0.30	R
TMK316BLD106□L-T		25		X5R	10 μ	±10, ±20	10	150	1.6±0.30	R

● 325TYPE

[Temperature Characteristic LD : X5R] 1.9mm thickness (N)

Part number 1	Part number 2	Rated voltage [V]	Temperature characteristics		Capacitance [F]	Capacitance tolerance [%]	tan δ [%]	HTLT	Thickness*3 [mm]	Soldering R:Reflow W:Wave
								Rated voltage x %		
UMK325 LD105□N-T		50		X5R	1 μ	±10, ±20	10	200	1.9±0.20	R

[Temperature Characteristic LD : X5R] 2.5mm thickness (M)

Part number 1	Part number 2	Rated voltage [V]	Temperature characteristics		Capacitance [F]	Capacitance tolerance [%]	tan δ [%]	HTLT	Thickness*3 [mm]	Soldering R:Reflow W:Wave
								Rated voltage x %		
UMK325 LD155□M-P		50		X5R	1.5 μ	±10, ±20	5	150	2.5±0.20	R
UMK325 LD475□M-P				X5R	4.7 μ	±10, ±20	10	200	2.5±0.20	R

Medium-High Voltage Multilayer Ceramic Capacitors

● 105TYPE

[Temperature Characteristic B7 : X7R] 0.5mm thickness (V)

Part number 1	Part number 2	Rated voltage [V]	Temperature characteristics		Capacitance [F]	Capacitance tolerance [%]	tan δ [%]	HTLT	Thickness*3 [mm]	Soldering R:Reflow W:Wave
								Rated voltage x %		
HMK105 B7221□V-F		100		X7R	220 p	±10, ±20	2.5	200	0.5±0.05	R
HMK105 B7331□V-F				X7R	330 p	±10, ±20	2.5	200	0.5±0.05	R
HMK105 B7471□V-F				X7R	470 p	±10, ±20	2.5	200	0.5±0.05	R
HMK105 B7681□V-F				X7R	680 p	±10, ±20	2.5	200	0.5±0.05	R
HMK105 B7102□V-F				X7R	1000 p	±10, ±20	2.5	200	0.5±0.05	R
HMK105 B7152□V-F				X7R	1500 p	±10, ±20	2.5	200	0.5±0.05	R
HMK105 B7222□V-F				X7R	2200 p	±10, ±20	2.5	200	0.5±0.05	R
HMK105 B7332□V-F				X7R	3300 p	±10, ±20	2.5	200	0.5±0.05	R
HMK105 B7472□V-F				X7R	4700 p	±10, ±20	2.5	200	0.5±0.05	R

[Temperature Characteristic CG : CG/C0G] 0.5mm thickness (V)

Part number 1	Part number 2	Rated voltage [V]	Temperature characteristics		Capacitance [F]	Capacitance tolerance [%]	Q (at 1MHz) min	HTLT	Thickness*3 [mm]	Soldering R:Reflow W:Wave
								Rated voltage x %		
HMK105 CG080DV-F		100	CG	C0G	8 p	±0.5pF	560	200	0.5±0.05	R
HMK105 CG090DV-F			CG	C0G	9 p	±0.5pF	580	200	0.5±0.05	R
HMK105 CG100DV-F			CG	C0G	10 p	±0.5pF	600	200	0.5±0.05	R
HMK105 CG120JV-F			CG	C0G	12 p	±5%	640	200	0.5±0.05	R
HMK105 CG150JV-F			CG	C0G	15 p	±5%	700	200	0.5±0.05	R
HMK105 CG180JV-F			CG	C0G	18 p	±5%	760	200	0.5±0.05	R
HMK105 CG220JV-F			CG	C0G	22 p	±5%	840	200	0.5±0.05	R
HMK105 CG240JV-F			CG	C0G	24 p	±5%	880	200	0.5±0.05	R
HMK105 CG270JV-F			CG	C0G	27 p	±5%	940	200	0.5±0.05	R
HMK105 CG330JV-F			CG	C0G	33 p	±5%	1000	200	0.5±0.05	R
HMK105 CG390JV-F			CG	C0G	39 p	±5%	1000	200	0.5±0.05	R
HMK105 CG470JV-F			CG	C0G	47 p	±5%	1000	200	0.5±0.05	R
HMK105 CG560JV-F			CG	C0G	56 p	±5%	1000	200	0.5±0.05	R
HMK105 CG680JV-F			CG	C0G	68 p	±5%	1000	200	0.5±0.05	R
HMK105 CG820JV-F			CG	C0G	82 p	±5%	1000	200	0.5±0.05	R
HMK105 CG101JV-F			CG	C0G	100 p	±5%	1000	200	0.5±0.05	R

● 107TYPE

[Temperature Characteristic BJ : B/X5R] 0.8mm thickness (A)

Part number 1	Part number 2	Rated voltage [V]	Temperature characteristics		Capacitance [F]	Capacitance tolerance [%]	tan δ [%]	HTLT	Thickness*3 [mm]	Soldering R:Reflow W:Wave
								Rated voltage x %		
HMK107 BJ102□A-T		100	B	X5R ⁺¹	1000 p	±10, ±20	3.5	200	0.8±0.10	R
HMK107 BJ152□A-T			B	X5R ⁺¹	1500 p	±10, ±20	3.5	200	0.8±0.10	R
HMK107 BJ222□A-T			B	X5R ⁺¹	2200 p	±10, ±20	3.5	200	0.8±0.10	R
HMK107 BJ332□A-T			B	X5R ⁺¹	3300 p	±10, ±20	3.5	200	0.8±0.10	R
HMK107 BJ472□A-T			B	X5R ⁺¹	4700 p	±10, ±20	3.5	200	0.8±0.10	R
HMK107 BJ682□A-T			B	X5R ⁺¹	6800 p	±10, ±20	3.5	200	0.8±0.10	R
HMK107 BJ103□A-T			B	X5R ⁺¹	0.01 μ	±10, ±20	3.5	200	0.8±0.10	R
HMK107 BJ153□A-T			B	X5R ⁺¹	0.015 μ	±10, ±20	3.5	200	0.8±0.10	R
HMK107 BJ223□A-T			B	X5R ⁺¹	0.022 μ	±10, ±20	3.5	200	0.8±0.10	R
HMK107 BJ333□A-T			B	X5R ⁺¹	0.033 μ	±10, ±20	3.5	200	0.8±0.10	R
HMK107 BJ473□A-T			B	X5R ⁺¹	0.047 μ	±10, ±20	3.5	200	0.8±0.10	R
HMK107 BJ104□A-T			B	X5R ⁺¹	0.1 μ	±10, ±20	3.5	200	0.8±0.10	R
HMK107 BJ224□A-TE			B	X5R ⁺¹	0.22 μ	±10, ±20	3.5	150	0.8±0.10	R/W

[Temperature Characteristic C7 : X7S] 0.8mm thickness (A)

Part number 1	Part number 2	Rated voltage [V]	Temperature characteristics		Capacitance [F]	Capacitance tolerance [%]	tan δ [%]	HTLT	Thickness*3 [mm]	Soldering R:Reflow W:Wave
								Rated voltage x %		
HMK107 C7224□A-TE		100		X7S	0.22 μ	±10, ±20	3.5	150	0.8±0.10	R/W

▶ This catalog contains the typical specification only due to the limitation of space. When you consider the purchase of our products, please check our specification. For details of each product (characteristics graph, reliability information, precautions for use, and so on), see our Web site (<http://www.ty-top.com/>).

■ PARTS NUMBER

【Temperature Characteristic B7 : X7R】 0.8mm thickness(A)

Part number 1	Part number 2	Rated voltage [V]	Temperature characteristics	Capacitance [F]	Capacitance tolerance [%]	tan δ [%]	HTLT		Soldering R:Reflow W:Wave
							Rated voltage x %	Thickness*3 [mm]	
HMK107 B7102□A-T		100	X7R	1000 p	±10, ±20	3.5	200	0.8±0.10	R
HMK107 B7152□A-T			X7R	1500 p	±10, ±20	3.5	200	0.8±0.10	R
HMK107 B7222□A-T			X7R	2200 p	±10, ±20	3.5	200	0.8±0.10	R
HMK107 B7332□A-T			X7R	3300 p	±10, ±20	3.5	200	0.8±0.10	R
HMK107 B7472□A-T			X7R	4700 p	±10, ±20	3.5	200	0.8±0.10	R
HMK107 B7682□A-T			X7R	6800 p	±10, ±20	3.5	200	0.8±0.10	R
HMK107 B7103□A-T			X7R	0.01 μ	±10, ±20	3.5	200	0.8±0.10	R
HMK107 B7153□A-T			X7R	0.015 μ	±10, ±20	3.5	200	0.8±0.10	R
HMK107 B7223□A-T			X7R	0.022 μ	±10, ±20	3.5	200	0.8±0.10	R
HMK107 B7333□A-T			X7R	0.033 μ	±10, ±20	3.5	200	0.8±0.10	R
HMK107 B7473□A-T			X7R	0.047 μ	±10, ±20	3.5	200	0.8±0.10	R
HMK107 B7104□A-T			X7R	0.1 μ	±10, ±20	3.5	200	0.8±0.10	R

【Temperature Characteristic SD : Standard】 0.8mm thickness(A)

Part number 1	Part number 2	Rated voltage [V]	Temperature characteristics	Capacitance [F]	Capacitance tolerance [%]	tan δ [%]	HTLT		Soldering R:Reflow W:Wave
							Rated voltage x %	Thickness*3 [mm]	
HMK107 SD101KA-T		100	Standard Type	100 p	±10	0.1	200	0.8±0.10	R
HMK107 SD121KA-T				120 p	±10	0.1	200	0.8±0.10	R
HMK107 SD151KA-T				150 p	±10	0.1	200	0.8±0.10	R
HMK107 SD181KA-T				180 p	±10	0.1	200	0.8±0.10	R
HMK107 SD221KA-T				220 p	±10	0.1	200	0.8±0.10	R
HMK107 SD271KA-T				270 p	±10	0.1	200	0.8±0.10	R
HMK107 SD331KA-T				330 p	±10	0.1	200	0.8±0.10	R
HMK107 SD391KA-T				390 p	±10	0.1	200	0.8±0.10	R
HMK107 SD471KA-T				470 p	±10	0.1	200	0.8±0.10	R
HMK107 SD561KA-T				560 p	±10	0.1	200	0.8±0.10	R
HMK107 SD681KA-T				680 p	±10	0.1	200	0.8±0.10	R
HMK107 SD821KA-T				820 p	±10	0.1	200	0.8±0.10	R
HMK107 SD102KA-T				1000 p	±10	0.1	200	0.8±0.10	R

● 212TYPE

【Temperature Characteristic BJ : B/X5R】 1.25mm thickness(G)

Part number 1	Part number 2	Rated voltage [V]	Temperature characteristics	Capacitance [F]	Capacitance tolerance [%]	tan δ [%]	HTLT		Soldering R:Reflow W:Wave		
							Rated voltage x %	Thickness*3 [mm]			
HMK212 BJ103□G-T		100	B X5R ⁺¹	0.01 μ	±10, ±20	3.5	200	1.25±0.10	R		
HMK212 BJ153□G-T				0.015 μ	±10, ±20	3.5	200	1.25±0.10	R		
HMK212 BJ223□G-T				0.022 μ	±10, ±20	3.5	200	1.25±0.10	R		
HMK212 BJ333□G-T				0.033 μ	±10, ±20	3.5	200	1.25±0.10	R		
HMK212 BJ473□G-T				0.047 μ	±10, ±20	3.5	200	1.25±0.10	R		
HMK212 BJ683□G-T				0.068 μ	±10, ±20	3.5	200	1.25±0.10	R		
HMK212 BJ104□G-T				0.1 μ	±10, ±20	3.5	200	1.25±0.10	R		
HMK212 BJ224□G-T				0.22 μ	±10, ±20	3.5	200	1.25±0.10	R		
HMK212 BJ474□G-TE				0.47 μ	±10, ±20	3.5	150	1.25±0.10	R		
HMK212BBJ105□G-TE				1 μ	±10, ±20	3.5	150	1.25+0.20/-0	R/W		
QMK212 BJ472□G-T				250	B X5R ⁺¹	4700 p	±10, ±20	2.5	150	1.25±0.10	R
QMK212 BJ682□G-T						6800 p	±10, ±20	2.5	150	1.25±0.10	R
QMK212 BJ103□G-T						0.01 μ	±10, ±20	2.5	150	1.25±0.10	R
QMK212 BJ153□G-T						0.015 μ	±10, ±20	2.5	150	1.25±0.10	R
QMK212 BJ223□G-T		0.022 μ	±10, ±20			2.5	150	1.25±0.10	R		

【Temperature Characteristic BJ : B/X5R】 0.85mm thickness(D)

Part number 1	Part number 2	Rated voltage [V]	Temperature characteristics	Capacitance [F]	Capacitance tolerance [%]	tan δ [%]	HTLT		Soldering R:Reflow W:Wave
							Rated voltage x %	Thickness*3 [mm]	
QMK212 BJ102□D-T		250	B X5R ⁺¹	1000 p	±10, ±20	2.5	150	0.85±0.10	R
QMK212 BJ152□D-T				1500 p	±10, ±20	2.5	150	0.85±0.10	R
QMK212 BJ222□D-T				2200 p	±10, ±20	2.5	150	0.85±0.10	R
QMK212 BJ332□D-T				3300 p	±10, ±20	2.5	150	0.85±0.10	R

【Temperature Characteristic C7 : X7S】 1.25mm thickness(G)

Part number 1	Part number 2	Rated voltage [V]	Temperature characteristics	Capacitance [F]	Capacitance tolerance [%]	tan δ [%]	HTLT		Soldering R:Reflow W:Wave
							Rated voltage x %	Thickness*3 [mm]	
HMK212 C7474□G-TE		100	X7S	0.47 μ	±10, ±20	3.5	150	1.25±0.10	R
HMK212BC7105□G-TE		100	X7S	1 μ	±10, ±20	3.5	150	1.25+0.20/-0	R/W

【Temperature Characteristic B7 : X7R】 1.25mm thickness(G)

Part number 1	Part number 2	Rated voltage [V]	Temperature characteristics	Capacitance [F]	Capacitance tolerance [%]	tan δ [%]	HTLT		Soldering R:Reflow W:Wave		
							Rated voltage x %	Thickness*3 [mm]			
HMK212 B7103□G-T		100	X7R	0.01 μ	±10, ±20	3.5	200	1.25±0.10	R		
HMK212 B7153□G-T				0.015 μ	±10, ±20	3.5	200	1.25±0.10	R		
HMK212 B7223□G-T				0.022 μ	±10, ±20	3.5	200	1.25±0.10	R		
HMK212 B7333□G-T				0.033 μ	±10, ±20	3.5	200	1.25±0.10	R		
HMK212 B7473□G-T				0.047 μ	±10, ±20	3.5	200	1.25±0.10	R		
HMK212 B7683□G-T				0.068 μ	±10, ±20	3.5	200	1.25±0.10	R		
HMK212 B7104□G-T				0.1 μ	±10, ±20	3.5	200	1.25±0.10	R		
HMK212 B7224□G-T				0.22 μ	±10, ±20	3.5	200	1.25±0.10	R		
QMK212 B7472□G-T				250	X7R	4700 p	±10, ±20	2.5	150	1.25±0.10	R
QMK212 B7682□G-T						6800 p	±10, ±20	2.5	150	1.25±0.10	R
QMK212 B7103□G-T						0.01 μ	±10, ±20	2.5	150	1.25±0.10	R
QMK212 B7153□G-T						0.015 μ	±10, ±20	2.5	150	1.25±0.10	R
QMK212 B7223□G-T						0.022 μ	±10, ±20	2.5	150	1.25±0.10	R

▶ This catalog contains the typical specification only due to the limitation of space. When you consider the purchase of our products, please check our specification. For details of each product (characteristics graph, reliability information, precautions for use, and so on), see our Web site (<http://www.ty-top.com/>).

PARTS NUMBER

[Temperature Characteristic B7 : X7R] 0.85mm thickness (D)

Part number 1	Part number 2	Rated voltage [V]	Temperature characteristics	Capacitance [F]	Capacitance tolerance [%]	tan δ [%]	HTLT	Thickness*3 [mm]	Soldering R:Reflow W:Wave
							Rated voltage x %		
QMK212 B7102□D-T		250	X7R	1000 p	±10, ±20	2.5	150	0.85±0.10	R
QMK212 B7152□D-T			X7R	1500 p	±10, ±20	2.5	150	0.85±0.10	R
QMK212 B7222□D-T			X7R	2200 p	±10, ±20	2.5	150	0.85±0.10	R
QMK212 B7332□D-T			X7R	3300 p	±10, ±20	2.5	150	0.85±0.10	R

[Temperature Characteristic SD : Standard] 0.85mm thickness (D)

Part number 1	Part number 2	Rated voltage [V]	Temperature characteristics	Capacitance [F]	Capacitance tolerance [%]	tan δ [%]	HTLT	Thickness*3 [mm]	Soldering R:Reflow W:Wave
							Rated voltage x %		
HMK212 SD222KD-T		100	Standard Type	2200 p	±10	0.1	200	0.85±0.10	R
HMK212 SD472KD-T				4700 p	±10	0.1	200	0.85±0.10	R
QMK212 SD101KD-T				100 p	±10	0.1	150	0.85±0.10	R
QMK212 SD121KD-T				120 p	±10	0.1	150	0.85±0.10	R
QMK212 SD151KD-T				150 p	±10	0.1	150	0.85±0.10	R
QMK212 SD181KD-T				180 p	±10	0.1	150	0.85±0.10	R
QMK212 SD221KD-T				220 p	±10	0.1	150	0.85±0.10	R
QMK212 SD331KD-T				330 p	±10	0.1	150	0.85±0.10	R
QMK212 SD391KD-T				390 p	±10	0.1	150	0.85±0.10	R
QMK212 SD471KD-T				470 p	±10	0.1	150	0.85±0.10	R
QMK212 SD561KD-T				560 p	±10	0.1	150	0.85±0.10	R
QMK212 SD681KD-T				680 p	±10	0.1	150	0.85±0.10	R
QMK212 SD821KD-T				820 p	±10	0.1	150	0.85±0.10	R
QMK212 SD102KD-T				1000 p	±10	0.1	150	0.85±0.10	R

[Temperature Characteristic SD : Standard] 1.25mm thickness (G)

Part number 1	Part number 2	Rated voltage [V]	Temperature characteristics	Capacitance [F]	Capacitance tolerance [%]	tan δ [%]	HTLT	Thickness*3 [mm]	Soldering R:Reflow W:Wave
							Rated voltage x %		
HMK212 SD392KG-T		100	Standard Type	3900 p	±10	0.1	200	1.25±0.10	R

316TYPE

[Temperature Characteristic BJ : B/X5R] 1.6mm thickness (L)

Part number 1	Part number 2	Rated voltage [V]	Temperature characteristics	Capacitance [F]	Capacitance tolerance [%]	tan δ [%]	HTLT	Thickness*3 [mm]	Soldering R:Reflow W:Wave	
							Rated voltage x %			
HMK316 BJ473□L-T		100	B	X5R ⁺	0.047 μ	±10, ±20	3.5	200	1.6±0.20	R
HMK316 BJ683□L-T			B	X5R ⁺	0.068 μ	±10, ±20	3.5	200	1.6±0.20	R
HMK316 BJ104□L-T			B	X5R ⁺	0.1 μ	±10, ±20	3.5	200	1.6±0.20	R
HMK316 BJ154□L-T			B	X5R ⁺	0.15 μ	±10, ±20	3.5	200	1.6±0.20	R
HMK316 BJ224□L-T			B	X5R ⁺	0.22 μ	±10, ±20	3.5	200	1.6±0.20	R
HMK316 BJ334□L-T			B	X5R ⁺	0.33 μ	±10, ±20	3.5	200	1.6±0.20	R
HMK316 BJ474□L-T			B	X5R ⁺	0.47 μ	±10, ±20	3.5	200	1.6±0.20	R
HMK316 BJ105□L-T			B	X5R ⁺	1 μ	±10, ±20	3.5	200	1.6±0.20	R
HMK316 ABJ225□L-TE			B	X5R ⁺	2.2 μ	±10, ±20	3.5	150	1.6±0.20	R/W
QMK316 BJ333□L-T			B	X5R ⁺	0.033 μ	±10, ±20	2.5	150	1.6±0.20	R
QMK316 BJ473□L-T			B	X5R ⁺	0.047 μ	±10, ±20	2.5	150	1.6±0.20	R
QMK316 BJ683□L-T			B	X5R ⁺	0.068 μ	±10, ±20	2.5	150	1.6±0.20	R
QMK316 BJ104□L-T			B	X5R ⁺	0.1 μ	±10, ±20	2.5	150	1.6±0.20	R
SMK316 BJ153□L-T			B	X5R ⁺	0.015 μ	±10, ±20	2.5	120	1.6±0.20	R
SMK316 BJ223□L-T			B	X5R ⁺	0.022 μ	±10, ±20	2.5	120	1.6±0.20	R

[Temperature Characteristic BJ : B/X5R] 1.15mm thickness (F)

Part number 1	Part number 2	Rated voltage [V]	Temperature characteristics	Capacitance [F]	Capacitance tolerance [%]	tan δ [%]	HTLT	Thickness*3 [mm]	Soldering R:Reflow W:Wave	
							Rated voltage x %			
SMK316 BJ102□F-T		630	B	X5R ⁺	1000 p	±10, ±20	2.5	120	1.15±0.10	R
SMK316 BJ152□F-T			B	X5R ⁺	1500 p	±10, ±20	2.5	120	1.15±0.10	R
SMK316 BJ222□F-T			B	X5R ⁺	2200 p	±10, ±20	2.5	120	1.15±0.10	R
SMK316 BJ332□F-T			B	X5R ⁺	3300 p	±10, ±20	2.5	120	1.15±0.10	R
SMK316 BJ472□F-T			B	X5R ⁺	4700 p	±10, ±20	2.5	120	1.15±0.10	R
SMK316 BJ682□F-T			B	X5R ⁺	6800 p	±10, ±20	2.5	120	1.15±0.10	R
SMK316 BJ103□F-T			B	X5R ⁺	0.01 μ	±10, ±20	2.5	120	1.15±0.10	R

[Temperature Characteristic C7 : X7S] 1.6mm thickness (L)

Part number 1	Part number 2	Rated voltage [V]	Temperature characteristics	Capacitance [F]	Capacitance tolerance [%]	tan δ [%]	HTLT	Thickness*3 [mm]	Soldering R:Reflow W:Wave
							Rated voltage x %		
HMK316 AC7225□L-TE		100	X7S	2.2 μ	±10, ±20	3.5	150	1.6±0.20	R/W

[Temperature Characteristic B7 : X7R] 1.6mm thickness (L)

Part number 1	Part number 2	Rated voltage [V]	Temperature characteristics	Capacitance [F]	Capacitance tolerance [%]	tan δ [%]	HTLT	Thickness*3 [mm]	Soldering R:Reflow W:Wave	
							Rated voltage x %			
HMK316 B7473□L-T		100	Standard Type	X7R	0.047 μ	±10, ±20	3.5	200	1.6±0.20	R
HMK316 B7683□L-T				X7R	0.068 μ	±10, ±20	3.5	200	1.6±0.20	R
HMK316 B7104□L-T				X7R	0.1 μ	±10, ±20	3.5	200	1.6±0.20	R
HMK316 B7154□L-T				X7R	0.15 μ	±10, ±20	3.5	200	1.6±0.20	R
HMK316 B7224□L-T				X7R	0.22 μ	±10, ±20	3.5	200	1.6±0.20	R
HMK316 B7334□L-T				X7R	0.33 μ	±10, ±20	3.5	200	1.6±0.20	R
HMK316 B7474□L-T				X7R	0.47 μ	±10, ±20	3.5	200	1.6±0.20	R
HMK316 B7105□L-T				X7R	1 μ	±10, ±20	3.5	200	1.6±0.20	R
QMK316 B7333□L-T				X7R	0.033 μ	±10, ±20	2.5	150	1.6±0.20	R
QMK316 B7473□L-T				X7R	0.047 μ	±10, ±20	2.5	150	1.6±0.20	R
QMK316 B7683□L-T				X7R	0.068 μ	±10, ±20	2.5	150	1.6±0.20	R
QMK316 B7104□L-T				X7R	0.1 μ	±10, ±20	2.5	150	1.6±0.20	R
SMK316 B7153□L-T				X7R	0.015 μ	±10, ±20	2.5	120	1.6±0.20	R
SMK316 B7223□L-T				X7R	0.022 μ	±10, ±20	2.5	120	1.6±0.20	R

► This catalog contains the typical specification only due to the limitation of space. When you consider the purchase of our products, please check our specification. For details of each product (characteristics graph, reliability information, precautions for use, and so on), see our Web site (<http://www.ty-top.com/>).

■ PARTS NUMBER

【Temperature Characteristic B7 : X7R】 1.15mm thickness(F)

Part number 1	Part number 2	Rated voltage [V]	Temperature characteristics	Capacitance [F]	Capacitance tolerance [%]	tan δ [%]	HTLT		Thickness*3 [mm]	Soldering R:Reflow W:Wave
							Rated voltage x %			
SMK316 B7102□F-T		630	X7R	1000 p	±10, ±20	2.5	120	1.15±0.10	R	
SMK316 B7152□F-T			X7R	1500 p	±10, ±20	2.5	120	1.15±0.10	R	
SMK316 B7222□F-T			X7R	2200 p	±10, ±20	2.5	120	1.15±0.10	R	
SMK316 B7332□F-T			X7R	3300 p	±10, ±20	2.5	120	1.15±0.10	R	
SMK316 B7472□F-T			X7R	4700 p	±10, ±20	2.5	120	1.15±0.10	R	
SMK316 B7682□F-T			X7R	6800 p	±10, ±20	2.5	120	1.15±0.10	R	
SMK316 B7103□F-T			X7R	0.01 μ	±10, ±20	2.5	120	1.15±0.10	R	

【Temperature Characteristic SD : Standard】 1.6mm thickness(L)

Part number 1	Part number 2	Rated voltage [V]	Temperature characteristics	Capacitance [F]	Capacitance tolerance [%]	tan δ [%]	HTLT		Thickness*3 [mm]	Soldering R:Reflow W:Wave
							Rated voltage x %			
HMK316 SD223KL-T		100	Standard Type	0.022 μ	±10	0.1	200	1.6±0.20	R	
QMK316 SD103KL-T		250		0.01 μ	±10	0.1	150	1.6±0.20	R	

● 325TYPE

【Temperature Characteristic BJ : B/X5R】 2.5mm thickness(M)

Part number 1	Part number 2	Rated voltage [V]	Temperature characteristics	Capacitance [F]	Capacitance tolerance [%]	tan δ [%]	HTLT		Thickness*3 [mm]	Soldering R:Reflow W:Wave
							Rated voltage x %			
HMK325 BJ225□M-P		100	B X5R ⁺	2.2 μ	±10, ±20	3.5	200	2.5±0.20	R	
HMK325 BJ475□M-PE		100	B X5R ⁺	4.7 μ	±10, ±20	3.5	150	2.5±0.20	R	

【Temperature Characteristic BJ : B/X5R】 1.9mm thickness(N)

Part number 1	Part number 2	Rated voltage [V]	Temperature characteristics	Capacitance [F]	Capacitance tolerance [%]	tan δ [%]	HTLT		Thickness*3 [mm]	Soldering R:Reflow W:Wave
							Rated voltage x %			
HMK325 BJ154□N-T		100	B X5R ⁺	0.15 μ	±10, ±20	3.5	200	1.9±0.20	R	
HMK325 BJ224□N-T			B X5R ⁺	0.22 μ	±10, ±20	3.5	200	1.9±0.20	R	
HMK325 BJ334□N-T			B X5R ⁺	0.33 μ	±10, ±20	3.5	200	1.9±0.20	R	
HMK325 BJ474□N-T			B X5R ⁺	0.47 μ	±10, ±20	3.5	200	1.9±0.20	R	
HMK325 BJ684□N-T			B X5R ⁺	0.68 μ	±10, ±20	3.5	200	1.9±0.20	R	
HMK325 BJ105□N-T			B X5R ⁺	1 μ	±10, ±20	3.5	200	1.9±0.20	R	
HMK325 BJ475□N-TE			B X5R ⁺	4.7 μ	±10, ±20	3.5	150	1.9±0.20	R	
QMK325 BJ473□N-T		250	B X5R ⁺	0.047 μ	±10, ±20	2.5	150	1.9±0.20	R	
QMK325 BJ104□N-T			B X5R ⁺	0.1 μ	±10, ±20	2.5	150	1.9±0.20	R	
QMK325 BJ154□N-T			B X5R ⁺	0.15 μ	±10, ±20	2.5	150	1.9±0.20	R	
QMK325 BJ224□N-T			B X5R ⁺	0.22 μ	±10, ±20	2.5	150	1.9±0.20	R	
SMK325 BJ223□N-T		630	B X5R ⁺	0.022 μ	±10, ±20	2.5	120	1.9±0.20	R	
SMK325 BJ333□N-T			B X5R ⁺	0.033 μ	±10, ±20	2.5	120	1.9±0.20	R	
SMK325 BJ473□N-T			B X5R ⁺	0.047 μ	±10, ±20	2.5	120	1.9±0.20	R	

【Temperature Characteristic BJ : B/X5R】 1.15mm thickness(F)

Part number 1	Part number 2	Rated voltage [V]	Temperature characteristics	Capacitance [F]	Capacitance tolerance [%]	tan δ [%]	HTLT		Thickness*3 [mm]	Soldering R:Reflow W:Wave
							Rated voltage x %			
HMK325 BJ104□F-T		100	B X5R ⁺	0.1 μ	±10, ±20	3.5	200	1.15±0.10	R	

【Temperature Characteristic B7 : X7R】 2.5mm thickness(M)

Part number 1	Part number 2	Rated voltage [V]	Temperature characteristics	Capacitance [F]	Capacitance tolerance [%]	tan δ [%]	HTLT		Thickness*3 [mm]	Soldering R:Reflow W:Wave
							Rated voltage x %			
HMK325 B7225□M-P		100	X7R	2.2 μ	±10, ±20	3.5	200	2.5±0.20	R	

【Temperature Characteristic B7 : X7R】 1.9mm thickness(N)

Part number 1	Part number 2	Rated voltage [V]	Temperature characteristics	Capacitance [F]	Capacitance tolerance [%]	tan δ [%]	HTLT		Thickness*3 [mm]	Soldering R:Reflow W:Wave
							Rated voltage x %			
HMK325 B7154□N-T		100	X7R	0.15 μ	±10, ±20	3.5	200	1.9±0.20	R	
HMK325 B7224□N-T			X7R	0.22 μ	±10, ±20	3.5	200	1.9±0.20	R	
HMK325 B7334□N-T			X7R	0.33 μ	±10, ±20	3.5	200	1.9±0.20	R	
HMK325 B7474□N-T			X7R	0.47 μ	±10, ±20	3.5	200	1.9±0.20	R	
HMK325 B7684□N-T			X7R	0.68 μ	±10, ±20	3.5	200	1.9±0.20	R	
HMK325 B7105□N-T			X7R	1 μ	±10, ±20	3.5	200	1.9±0.20	R	
QMK325 B7473□N-T			250	X7R	0.047 μ	±10, ±20	2.5	150	1.9±0.20	R
QMK325 B7104□N-T		X7R		0.1 μ	±10, ±20	2.5	150	1.9±0.20	R	
QMK325 B7154□N-T		X7R		0.15 μ	±10, ±20	2.5	150	1.9±0.20	R	
QMK325 B7224□N-T		X7R		0.22 μ	±10, ±20	2.5	150	1.9±0.20	R	
SMK325 B7223□N-T		630	X7R	0.022 μ	±10, ±20	2.5	120	1.9±0.20	R	
SMK325 B7333□N-T			X7R	0.033 μ	±10, ±20	2.5	120	1.9±0.20	R	
SMK325 B7473□N-T			X7R	0.047 μ	±10, ±20	2.5	120	1.9±0.20	R	

【Temperature Characteristic C7 : X7S】 2.5mm thickness(M)

Part number 1	Part number 2	Rated voltage [V]	Temperature characteristics	Capacitance [F]	Capacitance tolerance [%]	tan δ [%]	HTLT		Thickness*3 [mm]	Soldering R:Reflow W:Wave
							Rated voltage x %			
HMK325 C7475□M-PE		100	X7S	4.7 μ	±10, ±20	3.5	150	2.5±0.20	R	

【Temperature Characteristic C7 : X7S】 1.9mm thickness(N)

Part number 1	Part number 2	Rated voltage [V]	Temperature characteristics	Capacitance [F]	Capacitance tolerance [%]	tan δ [%]	HTLT		Thickness*3 [mm]	Soldering R:Reflow W:Wave
							Rated voltage x %			
HMK325 C7475□N-TE		100	X7S	4.7 μ	±10, ±20	3.5	150	1.9±0.20	R	

【Temperature Characteristic B7 : X7R】 1.15mm thickness(F)

Part number 1	Part number 2	Rated voltage [V]	Temperature characteristics	Capacitance [F]	Capacitance tolerance [%]	tan δ [%]	HTLT		Thickness*3 [mm]	Soldering R:Reflow W:Wave
							Rated voltage x %			
HMK325 B7104□F-T		100	X7R	0.1 μ	±10, ±20	3.5	200	1.15±0.10	R	

▶ This catalog contains the typical specification only due to the limitation of space. When you consider the purchase of our products, please check our specification. For details of each product (characteristics graph, reliability information, precautions for use, and so on), see our Web site (<http://www.ty-top.com/>).

■ PARTS NUMBER

● 432TYPE

[Temperature Characteristic BJ : B/X5R] 2.5mm thickness (M)

Part number 1	Part number 2	Rated voltage [V]	Temperature characteristics		Capacitance [F]	Capacitance tolerance [%]	tan δ [%]	HTLT	Thickness* ³ [mm]	Soldering R:Reflow W:Wave
								Rated voltage x %		
HMK432 BJ474[M-T]		100	B	X5R ⁺	0.47 μ	±10, ±20	3.5	200	2.5±0.20	R
HMK432 BJ105[M-T]			B	X5R ⁺	1 μ	±10, ±20	3.5	200	2.5±0.20	R
HMK432 BJ155[M-T]			B	X5R ⁺	1.5 μ	±10, ±20	3.5	200	2.5±0.20	R
HMK432 BJ225[M-T]			B	X5R ⁺	2.2 μ	±10, ±20	3.5	200	2.5±0.20	R
QMK432 BJ104[M-T]			B	X5R ⁺	0.1 μ	±10, ±20	2.5	150	2.5±0.20	R
QMK432 BJ224[M-T]			B	X5R ⁺	0.22 μ	±10, ±20	2.5	150	2.5±0.20	R
QMK432 BJ334[M-T]		250	B	X5R ⁺	0.33 μ	±10, ±20	2.5	150	2.5±0.20	R
QMK432 BJ474[M-T]			B	X5R ⁺	0.47 μ	±10, ±20	2.5	150	2.5±0.20	R
SMK432 BJ473[M-T]			B	X5R ⁺	0.047 μ	±10, ±20	2.5	120	2.5±0.20	R
SMK432 BJ683[M-T]		630	B	X5R ⁺	0.068 μ	±10, ±20	2.5	120	2.5±0.20	R
SMK432 BJ104[M-T]			B	X5R ⁺	0.1 μ	±10, ±20	2.5	120	2.5±0.20	R

[Temperature Characteristic B7 : X7R] 2.5mm thickness (M)

Part number 1	Part number 2	Rated voltage [V]	Temperature characteristics		Capacitance [F]	Capacitance tolerance [%]	tan δ [%]	HTLT	Thickness* ³ [mm]	Soldering R:Reflow W:Wave
								Rated voltage x %		
HMK432 B7474[M-T]		100		X7R	0.47 μ	±10, ±20	3.5	200	2.5±0.20	R
HMK432 B7105[M-T]				X7R	1 μ	±10, ±20	3.5	200	2.5±0.20	R
HMK432 B7155[M-T]				X7R	1.5 μ	±10, ±20	3.5	200	2.5±0.20	R
HMK432 B7225[M-T]				X7R	2.2 μ	±10, ±20	3.5	200	2.5±0.20	R
QMK432 B7104[M-T]				X7R	0.1 μ	±10, ±20	2.5	150	2.5±0.20	R
QMK432 B7224[M-T]			250		X7R	0.22 μ	±10, ±20	2.5	150	2.5±0.20
QMK432 B7334[M-T]				X7R	0.33 μ	±10, ±20	2.5	150	2.5±0.20	R
QMK432 B7474[M-T]				X7R	0.47 μ	±10, ±20	2.5	150	2.5±0.20	R
SMK432 B7473[M-T]		630		X7R	0.047 μ	±10, ±20	2.5	120	2.5±0.20	R
SMK432 B7683[M-T]				X7R	0.068 μ	±10, ±20	2.5	120	2.5±0.20	R
SMK432 B7104[M-T]				X7R	0.1 μ	±10, ±20	2.5	120	2.5±0.20	R

LW Reversal Decoupling Capacitors (LWDC™)

● 105TYPE

[Temperature Characteristic BJ : X5R] 0.3mm thickness (P)

Part number 1	Part number 2	Rated voltage [V]	Temperature characteristics		Capacitance [F]	Capacitance tolerance [%]	tan δ [%]	HTLT	Thickness* ³ [mm]	Soldering R:Reflow W:Wave	
								Rated voltage x %			
TWK105 BJ104MP-F		25		X5R	0.1 μ	±20	5	150	0.3±0.05	R	
EWK105 BJ224MP-F		16		X5R	0.22 μ	±20	10	150	0.3±0.05	R	
LWK105 BJ474MP-F		10		X5R	0.47 μ	±20	10	150	0.3±0.05	R	
JWK105 BJ104MP-F		6.3		X5R ⁺	0.1 μ	±20	5	150	0.3±0.05	R	
JWK105 BJ474MP-F				X5R ⁺	0.47 μ	±20	10	150	0.3±0.05	R	
JWK105 BJ105MP-F				X5R	1 μ	±20	10	150	0.3±0.05	R	
JWK105 BJ225MP-F				X5R	2.2 μ	±20	10	150	0.3±0.05	R	
AWK105 BJ224MP-F			4		X5R	0.22 μ	±20	10	150	0.3±0.05	R
AWK105 BJ224MP-F					X5R	0.22 μ	±20	10	150	0.3±0.05	R

[Temperature Characteristic C6 : X6S, C7 : X7S] 0.3mm thickness (P)

Part number 1	Part number 2	Rated voltage [V]	Temperature characteristics		Capacitance [F]	Capacitance tolerance [%]	tan δ [%]	HTLT	Thickness* ³ [mm]	Soldering R:Reflow W:Wave	
								Rated voltage x %			
EWK105 C6104MP-F		16		X6S	0.1 μ	±20	5	150	0.3±0.05	R	
LWK105 C7104MP-F		10		X7S	0.1 μ	±20	5	150	0.3±0.05	R	
LWK105 C6224MP-F				X6S	0.22 μ	±20	10	150	0.3±0.05	R	
JWK105 C7104MP-F				X7S	0.1 μ	±20	5	150	0.3±0.05	R	
JWK105 C7224MP-F			6.3		X7S	0.22 μ	±20	10	150	0.3±0.05	R
JWK105 C6474MP-F					X6S	0.47 μ	±20	10	150	0.3±0.05	R
AWK105 C6224MP-F					X6S	0.22 μ	±20	10	150	0.3±0.05	R
AWK105 C6474MP-F		4		X6S	0.47 μ	±20	10	150	0.3±0.05	R	
AWK105 C6105MP-F				X6S	1 μ	±20	10	150	0.3±0.05	R	
AWK105 C6225MP-F				X6S	2.2 μ	±20	10	150	0.3±0.05	R	

● 107TYPE

[Temperature Characteristic BJ : X5R] 0.5mm thickness (V)

Part number 1	Part number 2	Rated voltage [V]	Temperature characteristics		Capacitance [F]	Capacitance tolerance [%]	tan δ [%]	HTLT	Thickness* ³ [mm]	Soldering R:Reflow W:Wave	
								Rated voltage x %			
TWK107 BJ104MV-T		25		X5R ⁺	0.1 μ	±20	5	150	0.5±0.05	R	
EWK107 BJ224MV-T		16		X5R ⁺	0.22 μ	±20	5	150	0.5±0.05	R	
EWK107 BJ474MV-T				X5R ⁺	0.47 μ	±20	5	150	0.5±0.05	R	
LWK107 BJ105MV-T				X5R	1 μ	±20	10	150	0.5±0.05	R	
LWK107 BJ225MV-T			10		X5R	2.2 μ	±20	10	150	0.5±0.05	R
JWK107 BJ105MV-T					X5R ⁺	1 μ	±20	10	150	0.5±0.05	R
JWK107 BJ225MV-T					X5R	2.2 μ	±20	10	150	0.5±0.05	R
JWK107 BJ475MV-T		6.3		X5R	4.7 μ	±20	10	150	0.5±0.05	R	
AWK107 BJ106MV-T				X5R	10 μ	±20	10	150	0.5±0.05	R	

[Temperature Characteristic B7 : X7R, C6 : X6S, C7 : X7S] 0.5mm thickness (V)

Part number 1	Part number 2	Rated voltage [V]	Temperature characteristics		Capacitance [F]	Capacitance tolerance [%]	tan δ [%]	HTLT	Thickness* ³ [mm]	Soldering R:Reflow W:Wave
								Rated voltage x %		
TWK107 B7104MV-T		25		X7R	0.1 μ	±20	5	150	0.5±0.05	R
EWK107 B7224MV-T		16		X7R	0.22 μ	±20	5	150	0.5±0.05	R
EWK107 B7474MV-T				X7R	0.47 μ	±20	5	150	0.5±0.05	R
JWK107 C7105MV-T			6.3		X7S	1 μ	±20	10	150	0.5±0.05
AWK107 C7225MV-T				X7S	2.2 μ	±20	10	150	0.5±0.05	R
AWK107 C6475MV-T		4			X6S	4.7 μ	±20	10	150	0.5±0.05
PWK107 C6106MV-T				X6S	10 μ	±20	10	150	0.5±0.05	R

▶ This catalog contains the typical specification only due to the limitation of space. When you consider the purchase of our products, please check our specification. For details of each product (characteristics graph, reliability information, precautions for use, and so on), see our Web site (<http://www.ty-top.com/>).

■ PARTS NUMBER

● 212TYPE

【Temperature Characteristic BJ : X5R】 0.85mm thickness(D)

Part number 1	Part number 2	Rated voltage [V]	Temperature characteristics		Capacitance [F]	Capacitance tolerance [%]	tan δ [%]	HTLT	Thickness*3 [mm]	Soldering R:Reflow W:Wave
								Rated voltage x %		
TWK212 BJ475□D-T		25		X5R	4.7 μ	±10, ±20	10	150	0.85±0.10	R
EWK212 BJ106MD-T		16		X5R	10 μ	±20	10	150	0.85±0.10	R
LWK212 BJ475□D-T		10		X5R	4.7 μ	±10, ±20	10	150	0.85±0.10	R
LWK212 BJ106MD-T				X5R	10 μ	±20	10	150	0.85±0.10	R
JWK212 BJ226MD-T		6.3		X5R	22 μ	±20	10	150	0.85±0.10	R

【Temperature Characteristic B7 : X7R , C6 : X6S】 0.85mm thickness(D)

Part number 1	Part number 2	Rated voltage [V]	Temperature characteristics		Capacitance [F]	Capacitance tolerance [%]	tan δ [%]	HTLT	Thickness*3 [mm]	Soldering R:Reflow W:Wave
								Rated voltage x %		
TWK212 B7225□D-T		25		X7R	2.2 μ	±10, ±20	5	150	0.85±0.10	R
EWK212 C6475□D-T		16		X6S	4.7 μ	±10, ±20	10	150	0.85±0.10	R
LWK212 C6106MD-T		10		X6S	10 μ	±20	10	150	0.85±0.10	R
AWK212 C6226MD-T		4		X6S	22 μ	±20	10	150	0.85±0.10	R

► This catalog contains the typical specification only due to the limitation of space. When you consider the purchase of our products, please check our specification. For details of each product (characteristics graph, reliability information, precautions for use, and so on), see our Web site (<http://www.ty-top.com/>).

Multilayer Ceramic Capacitors

PACKAGING

① Minimum Quantity

● Taped package

Type(EIA)	Thickness		Standard quantity [pcs]	
	mm	code	Paper tape	Embossed tape
□MK021(008004)	0.125	K	—	50000
□MK042(01005)	0.2	C, D	—	40000
□VS042(01005)	0.2	C		
□MK063(0201)	0.3	P, T	15000	—
□WK105(0204) ※	0.3	P	10000	
□MK105(0402)	0.13	H	—	20000
	0.18	E	—	15000
	0.2	C	20000	—
	0.3	P	15000	
	0.5	V	10000	
□VK105(0402) ※	0.5	W	—	4000
□MK107(0603)	0.45	K	—	4000
□WK107(0306) ※	0.5	V	—	
□MR107(0603)	0.8	A	4000	—
□MK212(0805)	0.45	K		
□WK212(0508) ※	0.85	D		
□MR212(0805)	125	G	—	3000
□MK316(1206)	0.85	D	4000	—
	1.15	F	—	3000
	125	G	—	2000
□MK325(1210)	1.6	L	—	2000
	0.85	D	—	
	1.15	F		
	1.9	N		
	2.0max.	Y	2000	
□MR325(1210)	2.5	M	—	1000
□MK432(1812)	2.5	M	—	500

Note : ※ LW Reverse type.

② Taping material

※No bottom tape for pressed carrier tape

● Card board carrier tape

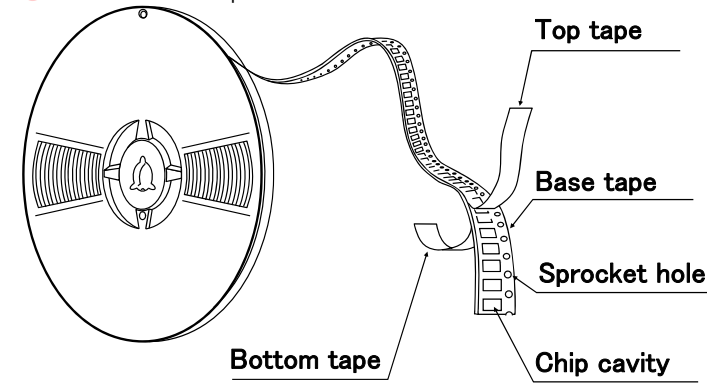

● Embossed tape

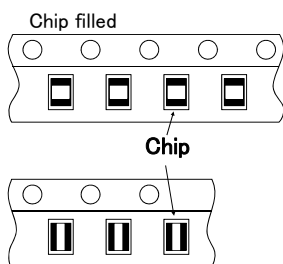
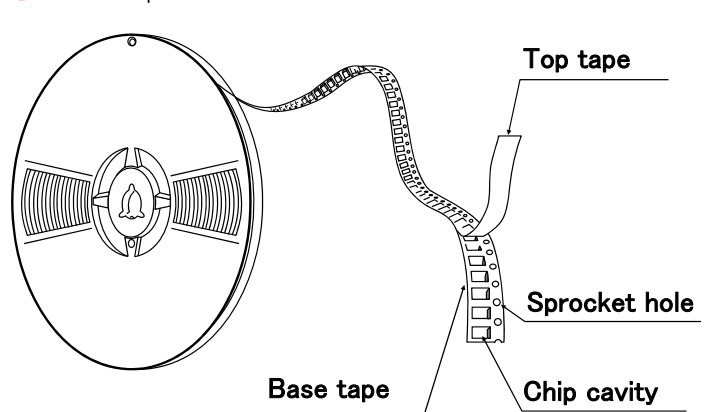

▶ This catalog contains the typical specification only due to the limitation of space. When you consider the purchase of our products, please check our specification. For details of each product (characteristics graph, reliability information, precautions for use, and so on), see our Web site (<http://www.ty-top.com/>).

③ Representative taping dimensions

- Paper Tape (8mm wide)
- Pressed carrier tape (2mm pitch)

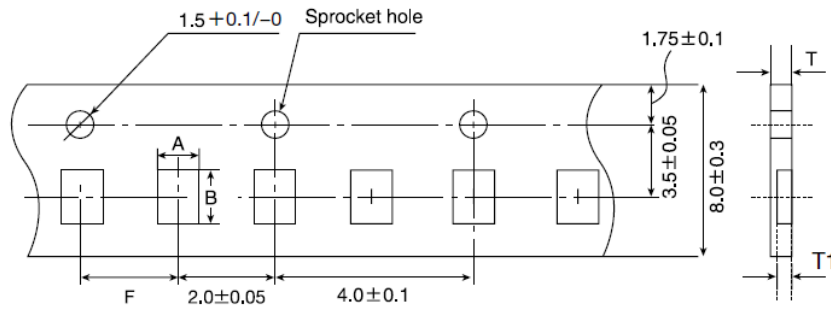

Unit : mm

Type(EIA)	Chip Cavity		Insertion Pitch F	Tape Thickness	
	A	B		T	T1
□MK063(0201)	0.37	0.67	2.0±0.05	0.45max.	0.42max.
□WK105(0204) ※	0.65	1.15		0.4max.	0.3max.
□MK105(0402) (*1 C)				0.45max.	0.42max.
□MK105(0402) (*1 P)					

Note *1 Thickness, C:0.2mm ,P:0.3mm. ※ LW Reverse type.

Unit : mm

- Punched carrier tape (2mm pitch)

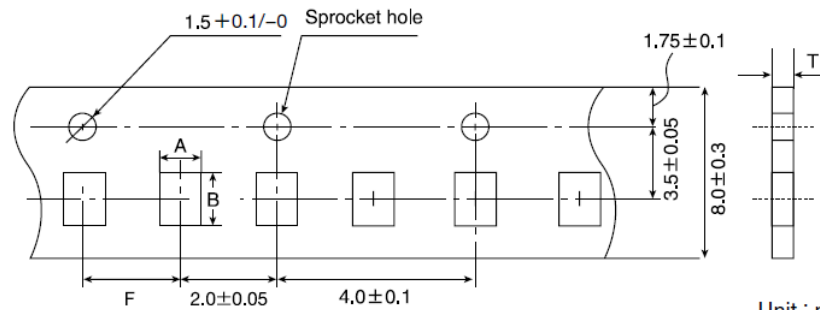

Unit : mm

Type(EIA)	Chip Cavity		Insertion Pitch F	Tape Thickness
	A	B		T
□MK105 (0402)	0.65	1.15	2.0±0.05	0.8max.
□VK105 (0402)				

Unit : mm

- Punched carrier tape (4mm pitch)

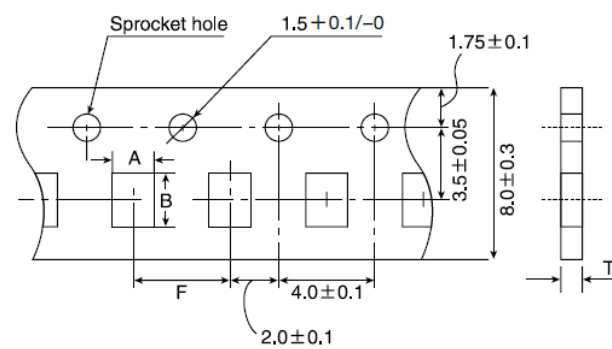

Unit : mm

Type(EIA)	Chip Cavity		Insertion Pitch F	Tape Thickness	
	A	B		T	
□MK107(0603)	1.0	1.8	4.0±0.1	1.1max.	
□WK107(0306) ※					
□MR107(0603)					
□MK212(0805)	1.65	2.4		4.0±0.1	1.1max.
□WK212(0508) ※					
□MK316(1206)	2.0	3.6			

Note : Taping size might be different depending on the size of the product. ※ LW Reverse type.

Unit : mm

● Embossed tape (4mm wide)

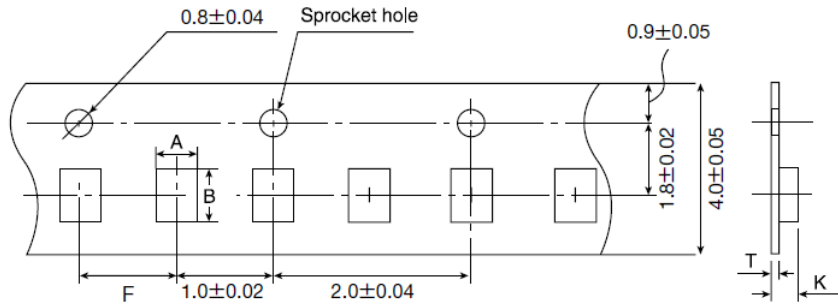

Unit : mm

Type(EIA)	Chip Cavity		Insertion Pitch F	Tape Thickness	
	A	B		K	T
□MK021(008004)	0.135	0.27	1.0±0.02	0.5max.	0.25max.
□MK042(01005)	0.23	0.43			
□VS042(01005)					

Unit: mm

● Embossed tape (8mm wide)

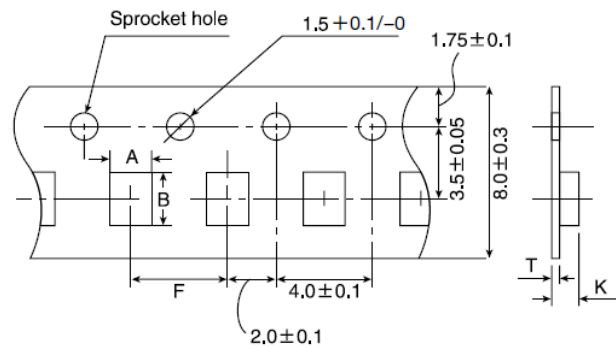

Unit : mm

Type(EIA)	Chip Cavity		Insertion Pitch F	Tape Thickness	
	A	B		K	T
□MK105(0402)	0.6	1.1	2.0±0.1	0.6max	0.2±0.1
□WK107(0306) ※	1.0	1.8	4.0±0.1	1.3max.	0.25±0.1
□MK212(0805)	1.65	2.4		3.4max.	0.6max.
□MR212(0805)					
□MK316(1206)	2.0	3.6			
□MR316(1206)	2.8	3.6			
□MK325(1210)					
□MR325(1210)					

Note: ※ LW Reverse type.

Unit: mm

● Embossed tape (12mm wide)

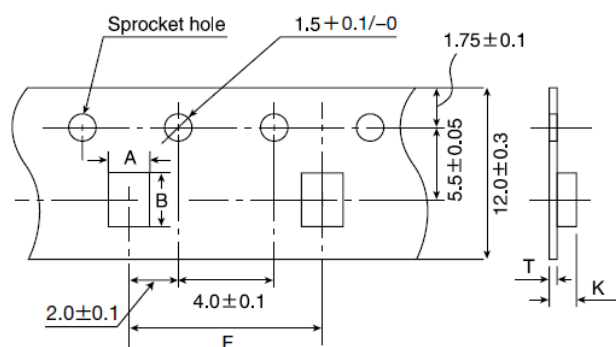

Unit : mm

Type(EIA)	Chip Cavity		Insertion Pitch F	Tape Thickness	
	A	B		K	T
□MK432(1812)	3.7	4.9	8.0±0.1	4.0max.	0.6max.

Unit: mm

▶ This catalog contains the typical specification only due to the limitation of space. When you consider the purchase of our products, please check our specification.
For details of each product (characteristics graph, reliability information, precautions for use, and so on), see our Web site (<http://www.ty-top.com/>).

④Trailer and Leader

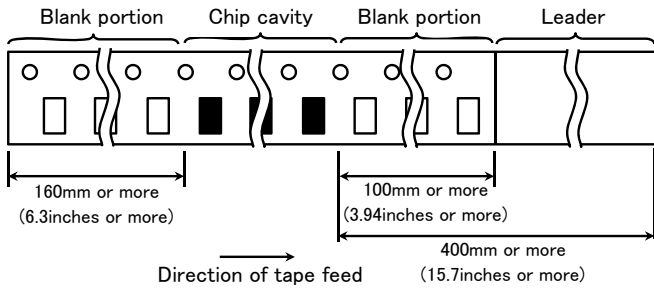

⑤Reel size

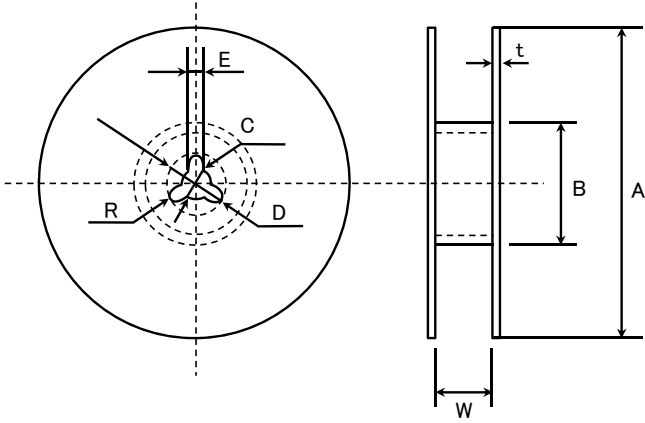

A	B	C	D	E	R
$\phi 178 \pm 2.0$	$\phi 50 \text{min.}$	$\phi 13.0 \pm 0.2$	$\phi 21.0 \pm 0.8$	2.0 ± 0.5	1.0
	T	W			
4mm wide tape	1.5max.	5 ± 1.0			
8mm wide tape	2.5max.	10 ± 1.5			
12mm wide tape	2.5max.	14 ± 1.5			

Unit: mm

⑥Top Tape Strength

The top tape requires a peel-off force of 0.1 to 0.7N in the direction of the arrow as illustrated below.

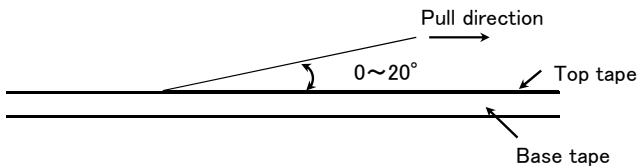

⑦Bulk Cassette

The exchange of individual specification is necessary. Please contact Taiyo Yuden sales channels.

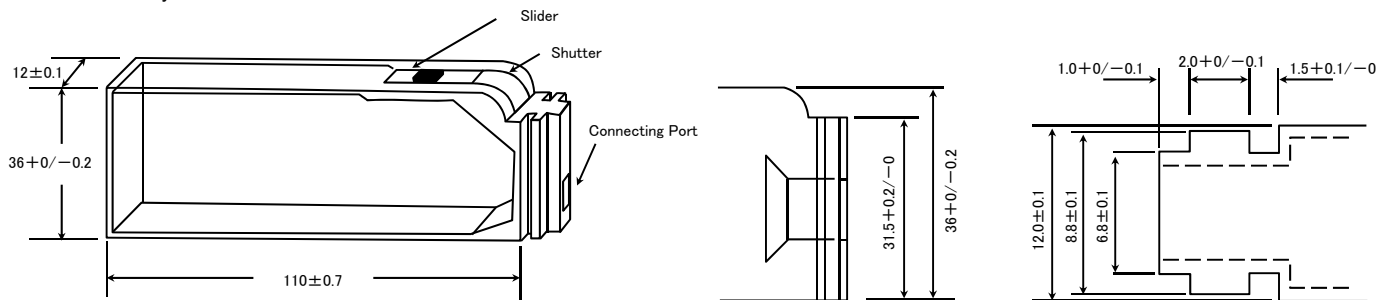

Unit: mm

Multilayer Ceramic Capacitors

RELIABILITY DATA

1. Operating Temperature Range

Specified Value	Temperature Compensating(Class1)	Standard	-55 to +125°C	
		High Frequency Type		
Specified Value	High Permittivity (Class2)		Specification	Temperature Range
		BJ	B	-25 to +85°C
			X5R	-55 to +85°C
		B7	X7R	-55 to +125°C
		C6	X6S	-55 to +105°C
		C7	X7S	-55 to +125°C
		LD(※)	X5R	-55 to +85°C
		F	F	-25 to +85°C
Y5V	-30 to +85°C			

Note: ※LD Low distortion high value multilayer ceramic capacitor

2. Storage Conditions

Specified Value	Temperature Compensating(Class1)	Standard	-55 to +125°C	
		High Frequency Type		
Specified Value	High Permittivity (Class2)		Specification	Temperature Range
		BJ	B	-25 to +85°C
			X5R	-55 to +85°C
		B7	X7R	-55 to +125°C
		C6	X6S	-55 to +105°C
		C7	X7S	-55 to +125°C
		LD(※)	X5R	-55 to +85°C
		F	F	-25 to +85°C
Y5V	-30 to +85°C			

Note: ※LD Low distortion high value multilayer ceramic capacitor

3. Rated Voltage

Specified Value	Temperature Compensating(Class1)	Standard	50VDC, 25VDC, 16VDC
		High Frequency Type	50VDC, 25VDC, 16VDC
	High Permittivity (Class2)		50VDC, 35VDC, 25VDC, 16VDC, 10VDC, 6.3VDC, 4VDC, 2.5VDC

4. Withstanding Voltage (Between terminals)

Specified Value	Temperature Compensating(Class1)	Standard	No breakdown or damage
		High Frequency Type	
Test Methods and Remarks	High Permittivity (Class2)		
	Applied voltage	Class 1 Rated voltage × 3	Class 2 Rated voltage × 2.5
	Duration	1 to 5 sec.	
	Charge/discharge current	50mA max.	

5. Insulation Resistance

Specified Value	Temperature Compensating(Class1)	Standard	10000 MΩ min.
		High Frequency Type	
Test Methods and Remarks	High Permittivity (Class2) Note 1		C ≤ 0.047 μF : 10000 MΩ min. C > 0.047 μF : 500MΩ · μF
	Applied voltage	: Rated voltage	
	Duration	: 60 ± 5 sec.	
Remarks	Charge/discharge current	: 50mA max.	

▶ This catalog contains the typical specification only due to the limitation of space. When you consider the purchase of our products, please check our specification. For details of each product (characteristics graph, reliability information, precautions for use, and so on), see our Web site (<http://www.ty-top.com/>).

6. Capacitance (Tolerance)					
Specified Value	Temperature Compensating(Class1)	Standard	C□	0.2pF ≤ C ≤ 5pF : ±0.25pF	
			U□	0.2pF ≤ C ≤ 10pF : ±0.5pF	
	SL	C > 10pF : ±5% or ±10%			
High Permittivity (Class2)	High Frequency Type	CH	0.2pF ≤ C ≤ 2pF	: ±0.1pF	
			C > 2pF	: ±5%	
High Permittivity (Class2)			BJ, B7, C6, C7, LD(※) : ±10% or ±20%, F : +80/-20% Note: ※LD Low distortion high value multilayer ceramic capacitor		
Test Methods and Remarks			Class 1		
			Standard	High Frequency Type	
	Preconditioning		None		
	Measuring frequency		1MHz ± 10%		
	Measuring voltage Note		0.5 to 5Vrms		
Bias application		None			
		Class 2			
		C ≤ 10 μF		C > 10 μF	
Preconditioning		Thermal treatment (at 150°C for 1hr) Note 2			
Measuring frequency		1kHz ± 10%		120 ± 10Hz	
Measuring voltage Note		1 ± 0.2Vrms		0.5 ± 0.1Vrms	
Bias application		None			

7. Q or Dissipation Factor					
Specified Value	Temperature Compensating(Class1)	Standard	C < 30pF : Q ≥ 400 + 20C C ≥ 30pF : Q ≥ 1000 (C: Nominal capacitance)		
			High Frequency Type	Refer to detailed specification	
	High Permittivity (Class2) Note 1		BJ, B7, C6, C7: 2.5% max., F: 7% max.		
Test Methods and Remarks			Class 1		
			Standard	High Frequency Type	
	Preconditioning		None		
	Measuring frequency		1MHz ± 10%		1GHz
	Measuring voltage Note 1		0.5 to 5Vrms		
Bias application		None			
		Class 2			
		C ≤ 10 μF		C > 10 μF	
Preconditioning		Thermal treatment (at 150°C for 1hr) Note 2			
Measuring frequency		1kHz ± 10%		120 ± 10Hz	
Measuring voltage Note 1		1 ± 0.2Vrms		0.5 ± 0.1Vrms	
Bias application		None			
High Frequency Type		Measuring equipment : HP4291A Measuring jig : HP16192A			

8. Temperature Characteristic (Without voltage application)				
Specified Value	Temperature Compensating(Class1)	Standard	Temperature Characteristic [ppm/°C]	
			C□ : 0	CG, CH, CJ, CK
	U□ : -750	UJ, UK	Tolerance [ppm/°C]	
High Permittivity (Class2)	High Frequency Type	CH	Temperature Characteristic [ppm/°C]	
			C□ : 0	H : ±60
		SL : +350 to -1000		
		Note : ※LD Low distortion high value multilayer ceramic capacitor		
Test Methods and Remarks	Class 1			
	Capacitance at 20°C and 85°C shall be measured in thermal equilibrium, and the temperature characteristic shall be calculated from the following equation.			
	$\frac{(C_{85} - C_{20})}{C_{20} \times \Delta T} \times 10^6 (\text{ppm}/^\circ\text{C}) \quad \Delta T = 65$			
	Class 2			
	Capacitance at each step shall be measured in thermal equilibrium, and the temperature characteristic shall be calculated from the following equation.			
	Step	B, F	X5R, X7R, X6S, X7S, Y5V	
	1	Minimum operating temperature		
	2	20°C	25°C	
	3	Maximum operating temperature		

▶ This catalog contains the typical specification only due to the limitation of space. When you consider the purchase of our products, please check our specification. For details of each product (characteristics graph, reliability information, precautions for use, and so on), see our Web site (<http://www.ty-top.com/>).

$$\frac{(C-C_2)}{C_2} \times 100(\%)$$

C : Capacitance in Step 1 or Step 3
C2 : Capacitance in Step 2

9. Deflection

Specified Value	Temperature Compensating(Class1)	Standard	Appearance : No abnormality Capacitance change : Within $\pm 5\%$ or ± 0.5 pF, whichever is larger.
		High Frequency Type	Appearance : No abnormality Capacitance change : Within ± 0.5 pF
	High Permittivity (Class2)		Appearance : No abnormality Capacitance change : Within $\pm 12.5\%$ (BJ, B7, C6, C7,LD(※)) Within $\pm 30\%$ (F) Note: ※LD Low distortion high value multilayer ceramic capacitor

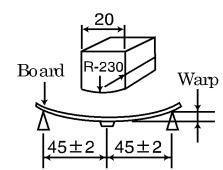
Test Methods and Remarks	<table border="1"> <thead> <tr> <th colspan="2">Multilayer Ceramic Capacitors</th> </tr> <tr> <th>042, 063, ※105 Type</th> <th>The other types</th> </tr> </thead> <tbody> <tr> <td>Board</td> <td>Glass epoxy-resin substrate</td> </tr> <tr> <td>Thickness</td> <td>0.8mm / 1.6mm</td> </tr> <tr> <td>Warp</td> <td>1mm</td> </tr> <tr> <td>Duration</td> <td>10 sec.</td> </tr> </tbody> </table>		Multilayer Ceramic Capacitors		042, 063, ※105 Type	The other types	Board	Glass epoxy-resin substrate	Thickness	0.8mm / 1.6mm	Warp	1mm	Duration	10 sec.	 <p>(Unit: mm) Capacitance measurement shall be conducted with the board bent</p>
	Multilayer Ceramic Capacitors														
042, 063, ※105 Type	The other types														
Board	Glass epoxy-resin substrate														
Thickness	0.8mm / 1.6mm														
Warp	1mm														
Duration	10 sec.														
<p>※105 Type thickness, C: 0.2mm ,P: 0.3mm.</p>															

10. Body Strength

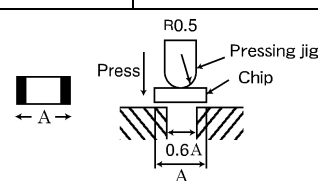
Specified Value	Temperature Compensating(Class1)	Standard	—
		High Frequency Type	No mechanical damage.
	High Permittivity (Class2)		—
Test Methods and Remarks	High Frequency Type Applied force : 5N Duration : 10 sec.		

11. Adhesive Strength of Terminal Electrodes

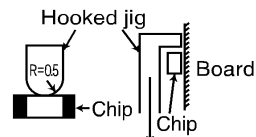
Specified Value	Temperature Compensating(Class1)	Standard	No terminal separation or its indication.								
		High Frequency Type									
	High Permittivity (Class2)										
Test Methods and Remarks	<table border="1"> <thead> <tr> <th colspan="2">Multilayer Ceramic Capacitors</th> </tr> <tr> <th>042, 063 Type</th> <th>105 Type or more</th> </tr> </thead> <tbody> <tr> <td>Applied force</td> <td>2N / 5N</td> </tr> <tr> <td>Duration</td> <td>30 \pm 5 sec.</td> </tr> </tbody> </table>		Multilayer Ceramic Capacitors		042, 063 Type	105 Type or more	Applied force	2N / 5N	Duration	30 \pm 5 sec.	
Multilayer Ceramic Capacitors											
042, 063 Type	105 Type or more										
Applied force	2N / 5N										
Duration	30 \pm 5 sec.										

12. Solderability

Specified Value	Temperature Compensating(Class1)	Standard	At least 95% of terminal electrode is covered by new solder.												
		High Frequency Type													
	High Permittivity (Class2)														
Test Methods and Remarks	<table border="1"> <thead> <tr> <th></th> <th>Eutectic solder</th> <th>Lead-free solder</th> </tr> </thead> <tbody> <tr> <td>Solder type</td> <td>H60A or H63A</td> <td>Sn-3.0Ag-0.5Cu</td> </tr> <tr> <td>Solder temperature</td> <td>230 \pm 5°C</td> <td>245 \pm 3°C</td> </tr> <tr> <td>Duration</td> <td colspan="2">4 \pm 1 sec.</td> </tr> </tbody> </table>			Eutectic solder	Lead-free solder	Solder type	H60A or H63A	Sn-3.0Ag-0.5Cu	Solder temperature	230 \pm 5°C	245 \pm 3°C	Duration	4 \pm 1 sec.		
	Eutectic solder	Lead-free solder													
Solder type	H60A or H63A	Sn-3.0Ag-0.5Cu													
Solder temperature	230 \pm 5°C	245 \pm 3°C													
Duration	4 \pm 1 sec.														

▶ This catalog contains the typical specification only due to the limitation of space. When you consider the purchase of our products, please check our specification. For details of each product (characteristics graph, reliability information, precautions for use, and so on), see our Web site (<http://www.ty-top.com/>).

13. Resistance to Soldering

Specified Value	Temperature Compensating(Class1)	Standard	Appearance : No abnormality Capacitance change : Within $\pm 2.5\%$ or $\pm 0.25\text{pF}$, whichever is larger. Q : Initial value Insulation resistance : Initial value Withstanding voltage (between terminals) : No abnormality
		High Frequency Type	Appearance : No abnormality Capacitance change : Within $\pm 2.5\%$ Q : Initial value Insulation resistance : Initial value Withstanding voltage (between terminals) : No abnormality
	High Permittivity (Class2) Note 1		Appearance : No abnormality Capacitance change : Within $\pm 7.5\%$ (BJ, B7, C6, C7, LD(※)) Within $\pm 20\%$ (F) Dissipation factor : Initial value Insulation resistance : Initial value Withstanding voltage (between terminals): No abnormality Note: ※LD Low distortion high value multilayer ceramic capacitor

Test Methods and Remarks	Class 1			
		042, 063 Type	105 Type	
	Preconditioning	None		
	Preheating	150°C, 1 to 2 min.	80 to 100°C, 2 to 5 min. 150 to 200°C, 2 to 5 min.	
	Solder temp.	270 \pm 5°C		
	Duration	3 \pm 0.5 sec.		
	Recovery	6 to 24 hrs (Standard condition) Note 5		
	Class 2			
		042, 063 Type	105, 107, 212 Type	316, 325 Type
	Preconditioning	Thermal treatment (at 150°C for 1 hr) Note 2		
	Preheating	150°C, 1 to 2 min.	80 to 100°C, 2 to 5 min. 150 to 200°C, 2 to 5 min.	80 to 100°C, 5 to 10 min. 150 to 200°C, 5 to 10 min.
	Solder temp.	270 \pm 5°C		
	Duration	3 \pm 0.5 sec.		
	Recovery	24 \pm 2 hrs (Standard condition) Note 5		

14. Temperature Cycle (Thermal Shock)

Specified Value	Temperature Compensating(Class1)	Standard	Appearance : No abnormality Capacitance change : Within $\pm 2.5\%$ or $\pm 0.25\text{pF}$, whichever is larger. Q : Initial value Insulation resistance : Initial value Withstanding voltage (between terminals) : No abnormality
		High Frequency Type	Appearance : No abnormality Capacitance change : Within $\pm 0.25\text{pF}$ Q : Initial value Insulation resistance : Initial value Withstanding voltage (between terminals) : No abnormality
	High Permittivity (Class2) Note 1		Appearance : No abnormality Capacitance change : Within $\pm 7.5\%$ (BJ, B7, C6, C7, LD(※)) Within $\pm 20\%$ (F) Dissipation factor : Initial value Insulation resistance : Initial value Withstanding voltage (between terminals) : No abnormality Note: ※LD Low distortion high value multilayer ceramic capacitor

Test Methods and Remarks	Class 1		Class 2		
	Preconditioning	None		Thermal treatment (at 150°C for 1 hr) Note 2	
	1 cycle	Step	Temperature(°C)	Time(min.)	
		1	Minimum operating temperature	30 \pm 3	
		2	Normal temperature	2 to 3	
		3	Maximum operating temperature	30 \pm 3	
4	Normal temperature	2 to 3			
Number of cycles	5 times				
Recovery	6 to 24 hrs (Standard condition) Note 5		24 \pm 2 hrs (Standard condition) Note 5		

▶ This catalog contains the typical specification only due to the limitation of space. When you consider the purchase of our products, please check our specification.
For details of each product (characteristics graph, reliability information, precautions for use, and so on), see our Web site (<http://www.ty-top.com/>).

15. Humidity (Steady State)

Specified Value	Temperature Compensating(Class1)	Standard	Appearance	: No abnormality			
			Capacitance change	: Within $\pm 5\%$ or $\pm 0.5\text{pF}$, whichever is larger.			
	High Frequency Type	Standard	Q	: $C < 10\text{pF}$: $Q \geq 200 + 10C$ $10 \leq C < 30\text{pF}$: $Q \geq 275 + 2.5C$ $C \geq 30\text{pF}$: $Q \geq 350$ (C: Nominal capacitance)			
Insulation resistance			: 1000 M Ω min.				
Test Methods and Remarks	High Permittivity (Class2) Note 1	Standard	Appearance	: No abnormality			
			Capacitance change	: Within $\pm 12.5\%$ (BJ, B7, C6, C7, LD(※)) Within $\pm 30\%$ (F)			
			Dissipation factor	: 5.0% max. (BJ, B7, C6, C7, LD(※)) 11.0% max. (F)			
Test Methods and Remarks	Class 1	Standard	Preconditioning	None			
			Temperature	40 \pm 2 $^{\circ}$ C			
			Humidity	90 to 95%RH			
			Duration	500+24/-0 hrs			
			Recovery	6 to 24 hrs (Standard condition) Note 5			
			Test Methods and Remarks	Class 2	All items	Preconditioning	Thermal treatment (at 150 $^{\circ}$ C for 1 hr) Note 2
						Temperature	40 \pm 2 $^{\circ}$ C
Humidity	90 to 95%RH						
Duration	500+24/-0 hrs						
Recovery	24 \pm 2 hrs (Standard condition) Note 5						

16. Humidity Loading

Specified Value	Temperature Compensating(Class1)	Standard	Appearance	: No abnormality
			Capacitance change	: Within $\pm 7.5\%$ or $\pm 0.75\text{pF}$, whichever is larger.
	High Frequency Type	Standard	Q	: $C < 30\text{pF}$: $Q \geq 100 + 10C/3$ $C \geq 30\text{pF}$: $Q \geq 200$ (C: Nominal capacitance)
Insulation resistance			: 500 M Ω min.	
Test Methods and Remarks	High Permittivity (Class2) Note 1	Standard	Appearance	: No abnormality
			Capacitance change	: Within $\pm 12.5\%$ (BJ, B7, C6, C7, LD(※)) Within $\pm 30\%$ (F)
			Dissipation factor	: 5.0% max. (BJ, B7, C6, C7, LD(※)) 11.0% max. (F)
Test Methods and Remarks	Class 1	Standard	Preconditioning	None
			Temperature	40 \pm 2 $^{\circ}$ C
			Humidity	90 to 95%RH
			Duration	500+24/-0 hrs
			Applied voltage	Rated voltage
			Charge/discharge current	50mA max.
			Recovery	6 to 24 hrs (Standard condition) Note 5
Test Methods and Remarks	Class 2	All items	Preconditioning	Voltage treatment (Rated voltage are applied for 1 hour at 40 $^{\circ}$ C) Note 3
			Temperature	40 \pm 2 $^{\circ}$ C
			Humidity	90 to 95%RH
			Duration	500+24/-0 hrs
			Applied voltage	Rated voltage
			Charge/discharge current	50mA max.
			Recovery	24 \pm 2 hrs (Standard condition) Note 5

► This catalog contains the typical specification only due to the limitation of space. When you consider the purchase of our products, please check our specification. For details of each product (characteristics graph, reliability information, precautions for use, and so on), see our Web site (<http://www.ty-top.com/>).

17. High Temperature Loading

Specified Value	Temperature Compensating(Class1)	Standard	Appearance : No abnormality Capacitance change : Within $\pm 3\%$ or $\pm 0.3\text{pF}$, whichever is larger. Q : $C < 10\text{pF}$: $Q \geq 200 + 10C$ $10 \leq C < 30\text{pF}$: $Q \geq 275 + 2.5C$ $C \geq 30\text{pF}$: $Q \geq 350$ (C: Nominal capacitance) Insulation resistance : $1000 \text{ M}\Omega$ min.
		High Frequency Type	Appearance : No abnormality Capacitance change : Within $\pm 3\%$ or $\pm 0.3\text{pF}$, whichever is larger. Insulation resistance : $1000 \text{ M}\Omega$ min.
	High Permittivity (Class2) Note 1		Appearance : No abnormality Capacitance change : Within $\pm 12.5\%$ (BJ, B7, C6, C7, LD(※)) Within $\pm 30\%$ (F) Dissipation factor : 5.0% max.(BJ, B7, C6, C7, LD(※)) 11.0% max.(F) Insulation resistance : $50 \text{ M}\Omega \mu\text{F}$ or $1000 \text{ M}\Omega$, whichever is smaller. Note: ※LD Low distortion high value multilayer ceramic capacitor

Test Methods and Remarks		Class 1		Class 2		
		Standard	High Frequency Type	BJ, LD(※), F	C6	B7, C7
	Preconditioning	None		Voltage treatment (Twice the rated voltage shall be applied for 1 hour at 85°C , 105°C or 125°C) Note 3, 4		
	Temperature	Maximum operating temperature		Maximum operating temperature		
	Duration	$1000 + 48 / - 0$ hrs		$1000 + 48 / - 0$ hrs		
	Applied voltage	Rated voltage $\times 2$ Note 4		Rated voltage $\times 2$ Note 4		
	Charge/discharge current	50mA max.		50mA max.		
	Recovery	6 to 24hr (Standard condition) Note 5		24 ± 2 hrs (Standard condition) Note 5		

Note: ※LD Low distortion high value multilayer ceramic capacitor

Note 1 The figures indicate typical specifications. Please refer to individual specifications in detail.

Note 2 Thermal treatment : Initial value shall be measured after test sample is heat-treated at $150 \pm 0 / - 10^\circ\text{C}$ for an hour and kept at room temperature for 24 ± 2 hours.

Note 3 Voltage treatment : Initial value shall be measured after test sample is voltage-treated for an hour at both the temperature and voltage specified in the test conditions, and kept at room temperature for 24 ± 2 hours.

Note 4 150% of rated voltage is applicable to some items. Please refer to their specifications for further information.

Note 5 Standard condition: Temperature: 5 to 35°C , Relative humidity: 45 to 85 % RH, Air pressure: 86 to 106kPa When there are questions concerning measurement results, in order to provide correlation data, the test shall be conducted under the following condition.

Temperature: $20 \pm 2^\circ\text{C}$, Relative humidity: 60 to 70 % RH, Air pressure: 86 to 106kPa Unless otherwise specified, all the tests are conducted under the "standard condition".

Super Low Distortion Multilayer Ceramic Capacitors (CFCAP™)

RELIABILITY DATA

1. Operating Temperature Range

Specified Value	-55 to +125°C
-----------------	---------------

2. Storage Temperature Range

Specified Value	-55 to +125°C
-----------------	---------------

3. Rated Voltage

Specified Value	6.3VDC, 10VDC, 16VDC, 25VDC, 35VDC, 50VDC
-----------------	---

4. Dielectric Withstanding Voltage (Between terminals)

Specified Value	No breakdown or damage
Test Methods and Remarks	Applied voltage : Rated voltage × 3
	Duration : 1 to 5 sec.
	Charge/discharge current : 50mA max.

5. Insulation Resistance

Specified Value	10000 MΩ or 500MΩμF, whichever is smaller
Test Methods and Remarks	Applied voltage : Rated voltage
	Duration : 60±5 sec.
	Charge/discharge current : 50mA max.

6. Capacitance (Tolerance)

Specified Value	±10%
Test Methods and Remarks	Measuring frequency : 1kHz±10%
	Measuring voltage : 1±0.2Vrms
	Bias application : None

7. Dissipation Factor

Specified Value	0.1%max
Test Methods and Remarks	Measuring frequency : 1kHz±10%
	Measuring voltage : 1±0.2Vrms
	Bias application : None

8. Bending Strength

Specified Value	Appearance : No abnormality
	Capacitance change : ±5%
Test Methods and Remarks	Warp : 1mm
	Speed : 0.5mm/second
	Duration : 10 seconds
	Test board : glass epoxy resin substrate
	Thickness : 1.6mm

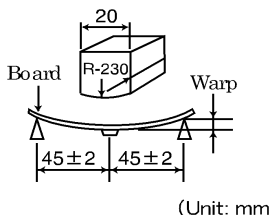

(Unit: mm)

Capacitance measurement shall be conducted with the board bent.

9. Adhesive Force of Terminal Electrodes

Specified Value	Terminal electrodes shall be no exfoliation or a sign of exfoliation.
Test Methods and Remarks	Applied force : 5N
	Duration : 30 ±5 seconds

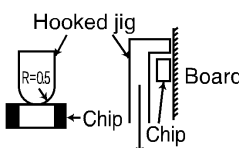

▶ This catalog contains the typical specification only due to the limitation of space. When you consider the purchase of our products, please check our specification. For details of each product (characteristics graph, reliability information, precautions for use, and so on), see our Web site (<http://www.ty-top.com/>) .

10. Solderability			
Specified Value	At least 95% of terminal electrode is covered by new solder.		
Test Methods and Remarks		Eutectic solder	Lead-free solder
	Solder type	H60A or H63A	Sn-3.0Ag-0.5Cu
	Solder temperature	230±5°C	245±3°C
	Duration	4±1 sec.	
11. Resistance to Soldering Heat			
Specified Value	Appearance	: No abnormality	
	Capacitance change	: ±2.5% max.	
	Dissipation factor	: Initial value	
	Insulation resistance	: Initial value	
	Withstanding voltage	(between terminals) : No abnormality	
Test Methods and Remarks	Solder temp.	: 270 ±5°C	
	Duration	: 3 ±0.5 sec.	
	Preheating conditions	: 80 to 100°C, 2 to 5 min. or 5 to 10 min. 150 to 200°C, 2 to 5 min. or 5 to 10 min.	
	Measurement shall be conducted	: 24±2hrs under the standard condition Note1	
12. Temperature Cycle (Thermal Shock)			
Specified Value	Appearance	: No abnormality	
	Capacitance change	: ±2.5% max	
	Dissipation factor	: Initial value	
	Insulation resistance	: Initial value	
	Withstanding voltage	(between terminals): No abnormality	
Test Methods and Remarks	Conditions for 1 cycle		
	Step	temperature (°C)	Time (min.)
	1	Minimum operating temperature	30±3 min.
	2	Normal temperature	2 to 3 min.
	3	Maximum operating temperature	30±3 min.
	4	Normal temperature	2 to 3 min.
Number of cycles: 5 times			
Measurement shall be conducted : 24±2hrs under the standard condition Note1			
13. Humidity (Steady state)			
Specified Value	Appearance	: No abnormality	
	Capacitance change	: ±5% max	
	Dissipation factor	: 0.5% max	
	Insulation resistance	: 50M ΩμF or 1000M Ω whichever is smaller	
Test Methods and Remarks	Temperature	: 40±2°C	
	Humidity	: 90 to 95% RH	
	Duration	: 500 +24/-0 hrs	
	Measurement shall be conducted	: 24 ±2hrs under the standard condition Note1	
14. Humidity Loading			
Specified Value	Appearance	: No abnormality	
	Capacitance change	: ±7.5% max	
	Dissipation factor	: 0.5% max	
	Insulation resistance	: 25M ΩμF or 500M Ω whichever is smaller	
Test Methods and Remarks	According to JIS C 5101-1.		
	Temperature	: 40±2°C	
	Humidity	: 90 to 95% RH	
	Duration	: 500 +24/-0 hrs	
	Applied voltage	: Rated voltage	
	Charge/discharge current	: 50mA max	
	Measurement shall be conducted	: 24 ±2hrs under the standard condition Note1	

15. High Temperature Loading

Specified Value	Appearance	: No abnormality
	Capacitance change	: $\pm 3\%$ max
	Dissipation factor	: 0.35% max
	Insulation resistance	: 50M Ω μ F or 1000M Ω whichever is smaller
Test Methods and Remarks	According to JIS C 5101-1.	
	Temperature	: Maximum operating temperature
	Duration	: 1000 +48/-0 hrs
	Applied voltage	: Rated voltage x 2
	Charge/discharge current	: 50mA max
Measurement shall be conducted	: 24 \pm 2hrs under the standard condition Note1	

Note1 Standard condition: Temperature: 5 to 35°C, Relative humidity: 45 to 85 % RH, Air pressure: 86 to 106kPa

When there are questions concerning measurement results, in order to provide correlation data, the test shall be conducted under the following condition.

Temperature: 20 \pm 2°C, Relative humidity: 60 to 70 % RH, Air pressure: 86 to 106kPa

Unless otherwise specified, all the tests are conducted under the "standard condition".

Medium-High Voltage Multilayer Ceramic Capacitor

RELIABILITY DATA

1. Operating Temperature Range		
Specified Value	Temperature Compensating(Class1)	CG : -55 to +125°C
	High Permittivity (Class2)	X7R, X7S : -55 to +125°C X5R : -55 to +85°C B : -25 to +85°C SD : -55 to +125°C
2. Storage Temperature Range		
Specified Value	Temperature Compensating(Class1)	CG : -55 to +125°C
	High Permittivity (Class2)	X7R, X7S : -55 to +125°C X5R : -55 to +85°C B : -25 to +85°C SD : -55 to +125°C
3. Rated Voltage		
Specified Value	Temperature Compensating(Class1)	100VDC(HMK)
	High Permittivity (Class2)	100VDC(HMK), 250VDC(QMK), 630VDC(SMK)
4. Withstanding Voltage(Between terminals)		
Specified Value	No breakdown or damage	
Test Methods and Remarks	Applied voltage : Rated voltage × 2.5(HMK), Rated voltage × 2(QMK), Rated voltage × 1.2(SMK) Duration : 1 to 5sec. Charge/discharge current : 50mA max.	
5. Insulation Resistance		
Specified Value	Temperature Compensating(Class1)	10000 MΩ min.
	High Permittivity (Class2)	100MΩ·μF or 10GΩ whichever is smaller.
Test Methods and Remarks	Applied voltage : Rated voltage(HMK, QMK), 500V(SMK) Duration : 60±5sec. Charge/discharge current : 50mA max.	
6. Capacitance (Tolerance)		
Specified Value	Temperature Compensating(Class1)	0.2pF ≤ C ≤ 5pF : ±0.25pF 0.2pF ≤ C ≤ 10pF : ±0.5pF C > 10pF : ±5% or ±10%
	High Permittivity (Class2)	±10%, ±20%
Test Methods and Remarks	Temperature Compensating(Class1)	Measuring frequency : 1MHz ± 10% Measuring voltage : 0.5~5Vrms Bias application : None
	High Permittivity (Class2)	Measuring frequency : 1kHz ± 10% Measuring voltage : 1 ± 0.2Vrms Bias application : None
7. Q or Dissipation Factor		
Specified Value	Temperature Compensating(Class1)	C < 30pF : Q ≥ 400 + 20C C ≥ 30pF : Q ≥ 1000 (C: Nominal capacitance)
	High Permittivity (Class2)	3.5%max(HMK), 2.5%max(QMK, SMK)
Test Methods and Remarks	Temperature Compensating(Class1)	Measuring frequency : 1MHz ± 10% Measuring voltage : 0.5~5Vrms Bias application : None
	High Permittivity (Class2)	Measuring frequency : 1kHz ± 10% Measuring voltage : 1 ± 0.2Vrms Bias application : None

▶ This catalog contains the typical specification only due to the limitation of space. When you consider the purchase of our products, please check our specification. For details of each product (characteristics graph, reliability information, precautions for use, and so on), see our Web site (<http://www.ty-top.com/>).

8. Temperature Characteristic of Capacitance													
Specified Value	Temperature Compensating(Class1)	CG : $0 \pm 30 \text{ppm}/^\circ\text{C} (-55 \text{ to } +125^\circ\text{C})$											
	High Permittivity (Class2)	B : $\pm 10\% (-25 \text{ to } +85^\circ\text{C})$ X5R : $\pm 15\% (-55 \text{ to } +85^\circ\text{C})$ X7R : $\pm 15\% (-55 \text{ to } +125^\circ\text{C})$ X7S : $\pm 22\% (-55 \text{ to } +125^\circ\text{C})$ SD : - ($-55 \text{ to } +125^\circ\text{C}$)											
Test Methods and Remarks	Capacitance value at each step shall be measured in thermal equilibrium, and the temperature characteristic shall be calculated from the following equation.												
	<table border="1"> <thead> <tr> <th>Step</th> <th>CG、</th> <th>B、X5R、X7R、X7S、SD</th> </tr> </thead> <tbody> <tr> <td>1</td> <td colspan="2">Minimum operating temperature</td> </tr> <tr> <td>2</td> <td>20°C</td> <td>25°C</td> </tr> <tr> <td>3</td> <td colspan="2">Maximum operating temperature</td> </tr> </tbody> </table>		Step	CG、	B、X5R、X7R、X7S、SD	1	Minimum operating temperature		2	20°C	25°C	3	Maximum operating temperature
Step	CG、	B、X5R、X7R、X7S、SD											
1	Minimum operating temperature												
2	20°C	25°C											
3	Maximum operating temperature												
$\frac{(C - C_2)}{C_2} \times 100(\%)$ <p>C : Capacitance value in Step 1 or Step 3 C2 : Capacitance value in Step 2</p>													

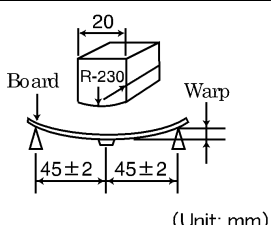
9. Deflection		
Specified Value	Temperature Compensating(Class1)	Appearance : No abnormality Capacitance change : Within $\pm 5\%$ or $\pm 0.5 \text{ pF}$, whichever is larger.
	High Permittivity (Class2)	Appearance : No abnormality Capacitance change : Within $\pm 10\%$
Test Methods and Remarks	Warp : 1mm Duration : 10sec. Test board : Glass epoxy-resin substrate Thickness : 1.6mm	
	Capacitance measurement shall be conducted with the board bent.	

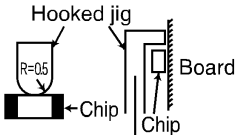
10. Adhesive Strength of Terminal Electrodes		
Specified Value	Temperature Compensating(Class1)	No terminal separation or its indication.
	High Permittivity (Class2)	
Test Methods and Remarks	Applied force : 5N Duration : $30 \pm 5 \text{sec.}$	

11. Solderability			
Specified Value	Temperature Compensating(Class1)	At least 95% of terminal electrode is covered by new solder	
	High Permittivity (Class2)		
Test Methods and Remarks		Eutectic solder	Lead-free solder
	Solder type	H60A or H63A	Sn-3.0Ag-0.5Cu
	Solder temperature	$230 \pm 5^\circ\text{C}$	$245 \pm 3^\circ\text{C}$
	Duration	$4 \pm 1 \text{ sec.}$	

12. Resistance to Soldering		
Specified Value	Temperature Compensating(Class1)	Appearance : No abnormality Capacitance change : Within $\pm 2.5\%$ or $\pm 0.25 \text{pF}$, whichever is larger.(HMK) Q : Initial value Insulation resistance : Initial value Withstanding voltage (between terminals) : No abnormality
	High Permittivity (Class2)	Appearance : No abnormality Capacitance change : Within $\pm 15\%$ (HMK), $\pm 10\%$ (QMK, SMK) Dissipation facto : Initial value Insulation resistance : Initial value Withstanding voltage (between terminals) : No abnormality

▶ This catalog contains the typical specification only due to the limitation of space. When you consider the purchase of our products, please check our specification.
For details of each product (characteristics graph, reliability information, precautions for use, and so on), see our Web site (<http://www.ty-top.com/>).

Test Methods and Remarks	Temperature Compensating(Class1)	
	Preconditioning	None
	Solder temperature	270±5°C
	Duration	3±0.5sec.
	Preheating conditions	80 to 100°C, 2 to 5 min. 150 to 200°C, 2 to 5min.
	Recovery	24±2hrs under the standard condition Note3
	High Permittivity (Class2)	
	Preconditioning	Thermal treatment(at 150°C for 1hr) Note1
	Solder temperature	270±5°C
	Duration	3±0.5sec.
	Preheating conditions	80 to 100°C, 2 to 5 min. 150 to 200°C, 2 to 5min.
	Recovery	24±2hrs under the standard condition Note3

13. Temperature Cycle (Thermal Shock)

Specified Value	Temperature Compensating(Class1)	Appearance : No abnormality Capacitance change : Within ±2.5% or ±0.25pF, whichever is larger.(HMK) Q : Initial value Insulation resistance : Initial value Withstanding voltage (between terminals) : No abnormality
	High Permittivity (Class2)	Appearance : No abnormality Capacitance change : Within ±15%(HMK), ±10%(QMK, SMK) Dissipation facto : Initial value Insulation resistance : Initial value Withstanding voltage (between terminals) : No abnormality

Test Methods and Remarks	Class 1		Class 2		
	Preconditioning	None	Thermal treatment (at 150°C for 1 hr) Note 1		
	1 cycle	Step	Temperature(°C)	Time (min.)	
		1	Minimum operating temperature	30±3	
		2	Normal temperature	2 to 3	
		3	Maximum operating temperature	30±3	
4	Normal temperature	2 to 3			
Number of cycles	5 times				
Recovery	6 to 24 hrs (Standard condition) Note 3	24±2 hrs (Standard condition) Note 3			

14. Humidity (Steady state)

Specified Value	Temperature Compensating(Class1)	Appearance : No abnormality Capacitance change : Within ±5% or ±0.5pF, whichever is larger.(HMK) Q : C < 10pF : Q ≥ 200 + 10C 10 ≤ C < 30pF : Q ≥ 275 + 2.5C C ≥ 30pF : Q ≥ 350 (C : Nominal capacitance) Insulation resistance : 1000 M Ω min.
	High Permittivity (Class2)	Appearance : No abnormality Capacitance change : Within ±15% Dissipation factor : 7%max (HMK), 5%max (QMK, SMK). Insulation resistance : 25M Ω μF or 1000M Ω whichever is smaller.

Test Methods and Remarks	Class 1		Class 2	
	Preconditioning	None	Thermal treatment (at 150°C for 1 hr) Note 1	
	Temperature	40±2°C	40±2°C	
	Humidity	90 to 95%RH	90 to 95%RH	
	Duration	500+24/-0 hrs	500+24/-0 hrs	
	Recovery	6 to 24 hrs (Standard condition) Note 3	24±2 hrs (Standard condition) Note 3	

▶ This catalog contains the typical specification only due to the limitation of space. When you consider the purchase of our products, please check our specification. For details of each product (characteristics graph, reliability information, precautions for use, and so on), see our Web site (<http://www.ty-top.com/>).

15. Humidity Loading			
Specified Value	Temperature Compensating(Class1)	Appearance : No abnormality Capacitance change : Within $\pm 7.5\%$ or $\pm 0.75\text{pF}$, whichever is larger (HMK). Q : $C < 30\text{pF} : Q \geq 100 + 10C/3$ $C \geq 30\text{pF} : Q \geq 200$ (C: Nominal capacitance) Insulation resistance : 500 M Ω min.	
	High Permittivity (Class2)	Appearance : No abnormality Capacitance change : Within $\pm 15\%$ Dissipation factor : 7%max (HMK), 5%max (QMK, SMK). Insulation resistance : 10M Ω μ F or 500M Ω whichever is smaller.	
Test Methods and Remarks	According to JIS 5101-1.		
		Class 1	Class 2
	Preconditioning	None	Voltage treatment (Rated voltage are applied for 1 hour at 40°C) Note 2
	Temperature	40 \pm 2°C	40 \pm 2°C
	Humidity	90 to 95%RH	90 to 95%RH
	Duration	500+24/-0 hrs	500+24/-0 hrs
	Applied voltage	Rated voltage	Rated voltage
	Charge/discharge current	50mA max.	50mA max.
Recovery	6 to 24 hrs (Standard condition) Note 3	24 \pm 2 hrs (Standard condition) Note 3	

16. High Temperature Loading			
Specified Value	Temperature Compensating(Class1)	Appearance : No abnormality Capacitance change : Within $\pm 7.5\%$ or $\pm 0.75\text{pF}$, whichever is larger.(HMK) Q : $C < 30\text{pF} : Q \geq 100 + 10C/3$ $C \geq 30\text{pF} : Q \geq 200$ (C: Nominal capacitance) Insulation resistance : 500 M Ω min.	
	High Permittivity (Class2)	Appearance : No abnormality Capacitance change : Within $\pm 15\%$ Dissipation factor : 7%max (HMK), 5%max (QMK, SMK). Insulation resistance : 50M Ω μ F or 1000M Ω whichever is smaller.	
Test Methods and Remarks	According to JIS 5101-1.		
		Class 1	Class 2
	Preconditioning	None	Voltage treatment Note 2
	Temperature	Maximum operating temperature	Maximum operating temperature
	Duration	1000+48/-0 hrs	1000+48/-0 hrs
	Applied voltage	Rated voltage \times 2(HMK)	Rated voltage \times 2(HMK), Rated voltage \times 1.5 (QMK), Rated voltage \times 1.2 (SMK)
	Charge/discharge current	50mA max.	50mA max.
	Recovery	6 to 24hr (Standard condition) Note 3	24 \pm 2 hrs (Standard condition) Note 3

Note1 Thermal treatment : Initial value shall be measured after test sample is heat-treated at 150+0/-10°C for an hour and kept at room temperature for 24 \pm 2hours.

Note2 Voltage treatment : Initial value shall be measured after test sample is voltage-treated for an hour at both the temperature and voltage specified in the test conditions, and kept at room temperature for 24 \pm 2hours.

Note3 Standard condition : Temperature: 5 to 35°C, Relative humidity: 45 to 85 % RH, Air pressure: 86 to 106kPa

When there are questions concerning measurement results, in order to provide correlation data, the test shall be conducted under the following condition.

Temperature: 20 \pm 2°C, Relative humidity: 60 to 70 % RH, Air pressure: 86 to 106kPa

Unless otherwise specified, all the tests are conducted under the "standard condition".

Precautions on the use of Multilayer Ceramic Capacitors

PRECAUTIONS

1. Circuit Design

- ◆Verification of operating environment, electrical rating and performance**
1. A malfunction of equipment in fields such as medical, aerospace, nuclear control, etc. may cause serious harm to human life or have severe social ramifications.
Therefore, any capacitors to be used in such equipment may require higher safety and reliability, and shall be clearly differentiated from them used in general purpose applications.
- ◆Operating Voltage (Verification of Rated voltage)**
1. The operating voltage for capacitors must always be their rated voltage or less.
If an AC voltage is loaded on a DC voltage, the sum of the two peak voltages shall be the rated voltage or less.
For a circuit where an AC or a pulse voltage may be used, the sum of their peak voltages shall also be the rated voltage or less.
 2. Even if an applied voltage is the rated voltage or less reliability of capacitors may be deteriorated in case that either a high frequency AC voltage or a pulse voltage having rapid rise time is used in a circuit.

2. PCB Design

- ◆Pattern configurations (Design of Land-patterns)**
1. When capacitors are mounted on PCBs, the amount of solder used (size of fillet) can directly affect the capacitor performance.
Therefore, the following items must be carefully considered in the design of land patterns:
 - (1) Excessive solder applied can cause mechanical stresses which lead to chip breaking or cracking. Therefore, please consider appropriate land-patterns for proper amount of solder.
 - (2) When more than one component are jointly soldered onto the same land, each component's soldering point shall be separated by solder-resist.
- ◆Pattern configurations (Capacitor layout on PCBs)**
- After capacitors are mounted on boards, they can be subjected to mechanical stresses in subsequent manufacturing processes (PCB cutting, board inspection, mounting of additional parts, assembly into the chassis, wave soldering of the boards, etc.). For this reason, land pattern configurations and positions of capacitors shall be carefully considered to minimize stresses.

- ◆Pattern configurations (Design of Land-patterns)**
- The following diagrams and tables show some examples of recommended land patterns to prevent excessive solder amounts.

(1) Recommended land dimensions for typical chip capacitors

● Multilayer Ceramic Capacitors : Recommended land dimensions (unit: mm)

		Wave-soldering			
Type		107	212	316	325
Size	L	1.6	2.0	3.2	3.2
	W	0.8	1.25	1.6	2.5
A		0.8 to 1.0	1.0 to 1.4	1.8 to 2.5	1.8 to 2.5
B		0.5 to 0.8	0.8 to 1.5	0.8 to 1.7	0.8 to 1.7
C		0.6 to 0.8	0.9 to 1.2	1.2 to 1.6	1.8 to 2.5

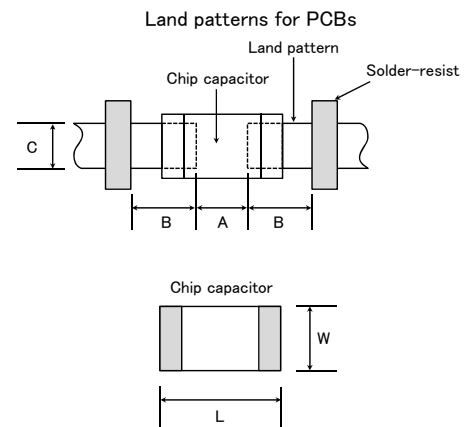

Technical considerations

		Reflow-soldering							
Type		042	063	105	107	212	316	325	432
Size	L	0.4	0.6	1.0	1.6	2.0	3.2	3.2	4.5
	W	0.2	0.3	0.5	0.8	1.25	1.6	2.5	3.2
A		0.15 to 0.25	0.20 to 0.30	0.45 to 0.55	0.8 to 1.0	0.8 to 1.2	1.8 to 2.5	1.8 to 2.5	2.5 to 3.5
B		0.15 to 0.20	0.20 to 0.30	0.40 to 0.50	0.6 to 0.8	0.8 to 1.2	1.0 to 1.5	1.0 to 1.5	1.5 to 1.8
C		0.15 to 0.30	0.25 to 0.40	0.45 to 0.55	0.6 to 0.8	0.9 to 1.6	1.2 to 2.0	1.8 to 3.2	2.3 to 3.5

Note: Recommended land size might be different according to the allowance of the size of the product.

● LWDC: Recommended land dimensions for reflow-soldering (unit: mm)

Type		105	107	212
Size	L	0.52	0.8	1.25
	W	1.0	1.6	2.0
A		0.18 to 0.22	0.25 to 0.3	0.5 to 0.7
B		0.2 to 0.25	0.3 to 0.4	0.4 to 0.5
C		0.9 to 1.1	1.5 to 1.7	1.9 to 2.1

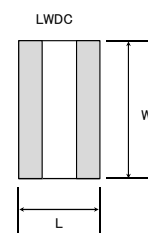

* This catalog contains the typical specification only due to the limitation of space. When you consider the purchase of our products, please check our specification. For details of each product (characteristics graph, reliability information, precautions for use, and so on), see our Web site (<http://www.ty-top.com/>).

(2) Examples of good and bad solder application

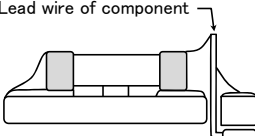
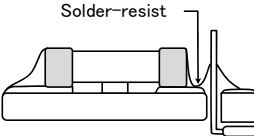
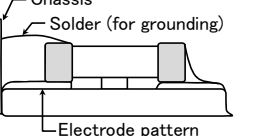
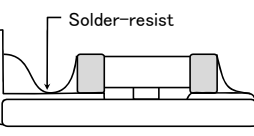
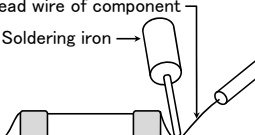
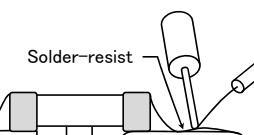
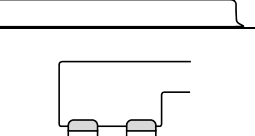
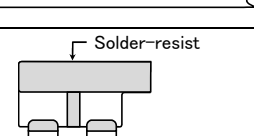
Item	Not recommended	Recommended
Mixed mounting of SMD and leaded components		
Component placement close to the chassis		
Hand-soldering of leaded components near mounted components		
Horizontal component placement		

◆ Pattern configurations (Capacitor layout on PCBs)

1-1. The following is examples of good and bad capacitor layouts ; capacitors shall be located to minimize any possible mechanical stresses from board warp or deflection.

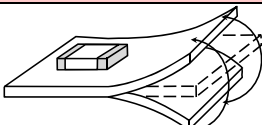
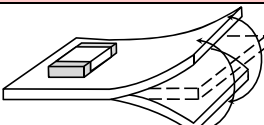
Items	Not recommended	Recommended
Deflection of board		 Place the product at a right angle to the direction of the anticipated mechanical stress.

1-2. The amount of mechanical stresses given will vary depending on capacitor layout. Please refer to diagram below.

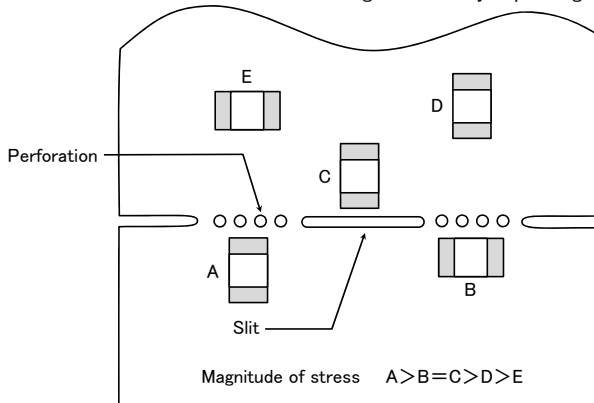

1-3. When PCB is split, the amount of mechanical stress on the capacitors can vary according to the method used. The following methods are listed in order from least stressful to most stressful: push-back, slit, V-grooving, and perforation. Thus, please consider the PCB, split methods as well as chip location.

3. Mounting

Precautions

◆ Adjustment of mounting machine

- When capacitors are mounted on PCB, excessive impact load shall not be imposed on them.
- Maintenance and inspection of mounting machines shall be conducted periodically.

◆ Selection of Adhesives

- When chips are attached on PCBs with adhesives prior to soldering, it may cause capacitor characteristics degradation unless the following factors are appropriately checked : size of land patterns, type of adhesive, amount applied, hardening temperature and hardening period. Therefore, please contact us for further information.

◆Adjustment of mounting machine

1. When the bottom dead center of a pick-up nozzle is too low, excessive force is imposed on capacitors and causes damages. To avoid this, the following points shall be considerable.
 - (1) The bottom dead center of the pick-up nozzle shall be adjusted to the surface level of PCB without the board deflection.
 - (2) The pressure of nozzle shall be adjusted between 1 and 3 N static loads.
 - (3) To reduce the amount of deflection of the board caused by impact of the pick-up nozzle, supporting pins or back-up pins shall be used on the other side of the PCB. The following diagrams show some typical examples of good and bad pick-up nozzle placement:

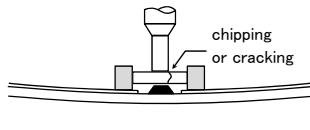
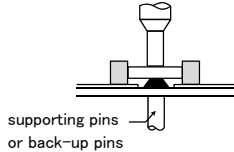
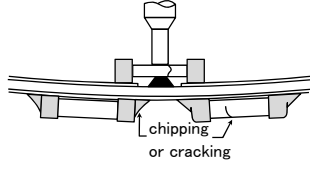
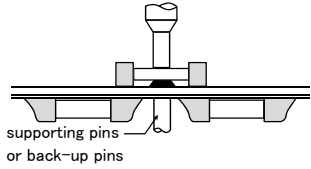
Item	Improper method	Proper method
Single-sided mounting		
Double-sided mounting		

Technical considerations

2. As the alignment pin is worn out, adjustment of the nozzle height can cause chipping or cracking of capacitors because of mechanical impact on the capacitors. To avoid this, the monitoring of the width between the alignment pins in the stopped position, maintenance, check and replacement of the pin shall be conducted periodically.

◆Selection of Adhesives

Some adhesives may cause IR deterioration. The different shrinkage percentage of between the adhesive and the capacitors may result in stresses on the capacitors and lead to cracking. Moreover, too little or too much adhesive applied to the board may adversely affect components. Therefore, the following precautions shall be noted in the application of adhesives.

- (1) Required adhesive characteristics
 - a. The adhesive shall be strong enough to hold parts on the board during the mounting & solder process.
 - b. The adhesive shall have sufficient strength at high temperatures.
 - c. The adhesive shall have good coating and thickness consistency.
 - d. The adhesive shall be used during its prescribed shelf life.
 - e. The adhesive shall harden rapidly.
 - f. The adhesive shall have corrosion resistance.
 - g. The adhesive shall have excellent insulation characteristics.
 - h. The adhesive shall have no emission of toxic gasses and no effect on the human body.
- (2) The recommended amount of adhesives is as follows;

[Recommended condition]

Figure	212/316 case sizes as examples
a	0.3mm min
b	100 to 120 μm
c	Adhesives shall not contact land

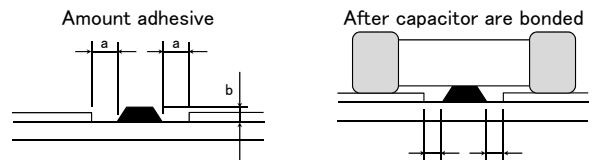

4. Soldering

◆Selection of Flux

- Since flux may have a significant effect on the performance of capacitors, it is necessary to verify the following conditions prior to use;
- (1) Flux used shall be less than or equal to 0.1 wt% (in Cl equivalent) of halogenated content. Flux having a strong acidity content shall not be applied.
 - (2) When shall capacitors are soldered on boards, the amount of flux applied shall be controlled at the optimum level.
 - (3) When water-soluble flux is used, special care shall be taken to properly clean the boards.

Precautions

◆Soldering

Temperature, time, amount of solder, etc. shall be set in accordance with their recommended conditions. Sn-Zn solder paste can adversely affect MLOC reliability. Please contact us prior to usage of Sn-Zn solder.

◆Selection of Flux

- 1-1. When too much halogenated substance (Chlorine, etc.) content is used to activate flux, or highly acidic flux is used, it may lead to corrosion of terminal electrodes or degradation of insulation resistance on the surfaces of the capacitors.
- 1-2. Flux is used to increase solderability in wave soldering. However if too much flux is applied, a large amount of flux gas may be emitted and may adversely affect the solderability. To minimize the amount of flux applied, it is recommended to use a flux-bubbling system.
- 1-3. Since the residue of water-soluble flux is easily dissolved in moisture in the air, the residues on the surfaces of capacitors in high humidity conditions may cause a degradation of insulation resistance and reliability of the capacitors. Therefore, the cleaning methods and the capability of the machines used shall also be considered carefully when water-soluble flux is used.

Technical considerations

▶ This catalog contains the typical specification only due to the limitation of space. When you consider the purchase of our products, please check our specification. For details of each product (characteristics graph, reliability information, precautions for use, and so on), see our Web site (<http://www.ty-top.com/>).

◆Soldering

- Ceramic chip capacitors are susceptible to thermal shock when exposed to rapid or concentrated heating or rapid cooling.
- Therefore, the soldering must be conducted with great care so as to prevent malfunction of the components due to excessive thermal shock.
- Preheating : Capacitors shall be preheated sufficiently, and the temperature difference between the capacitors and solder shall be within 130°C.
- Cooling : The temperature difference between the capacitors and cleaning process shall not be greater than 100°C.

[Reflow soldering]

【Recommended conditions for eutectic soldering】

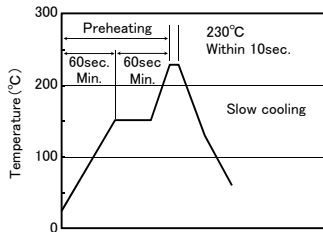

【Recommended condition for Pb-free soldering】

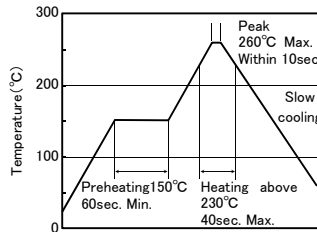

Caution

- ①The ideal condition is to have solder mass(fillet) controlled to 1/2 to 1/3 of the thickness of a capacitor.
- ②Because excessive dwell times can adversely affect solderability, soldering duration shall be kept as close to recommended times as possible.

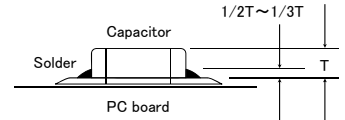

[Wave soldering]

【Recommended conditions for eutectic soldering】

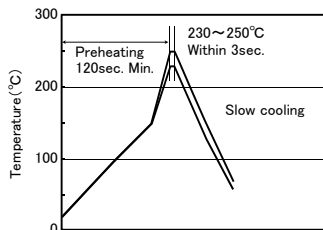

【Recommended condition for Pb-free soldering】

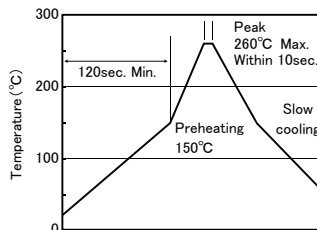

Caution

- ①Wave soldering must not be applied to capacitors designated as for reflow soldering only.

[Hand soldering]

【Recommended conditions for eutectic soldering】

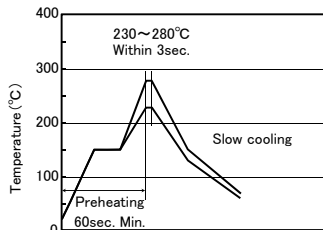

【Recommended condition for Pb-free soldering】

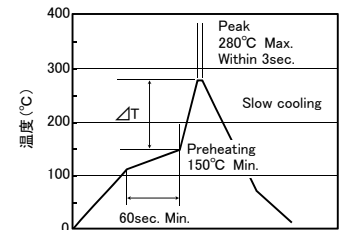
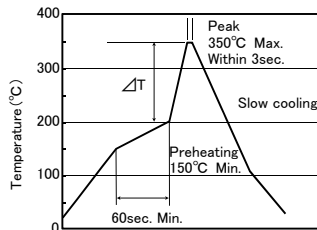

316type or less	$\Delta T \leq 150^{\circ}\text{C}$
-----------------	-------------------------------------

325type or more	$\Delta T \leq 130^{\circ}\text{C}$
-----------------	-------------------------------------

Caution

- ①Use a 50W soldering iron with a maximum tip diameter of 1.0 mm.
- ②The soldering iron shall not directly touch capacitors.

5. Cleaning

◆Cleaning conditions

Precautions

1. When PCBs are cleaned after capacitors mounting, please select the appropriate cleaning solution in accordance with the intended use of the cleaning. (e.g. to remove soldering flux or other materials from the production process.)
2. Cleaning condition shall be determined after it is verified by using actual cleaning machine that the cleaning process does not affect capacitor's characteristics.

Technical considerations

1. The use of inappropriate cleaning solutions can cause foreign substances such as flux residue to adhere to capacitors or deteriorate their outer coating, resulting in a degradation of the capacitor's electrical properties (especially insulation resistance).
2. Inappropriate cleaning conditions(insufficient or excessive cleaning) may adversely affect the performance of the capacitors. In the case of ultrasonic cleaning, too much power output can cause excessive vibration of PCBs which may lead to the cracking of capacitors or the soldered portion, or decrease the terminal electrodes' strength. Therefore, the following conditions shall be carefully checked:
 Ultrasonic output : 20 W/l or less
 Ultrasonic frequency : 40 kHz or less
 Ultrasonic washing period : 5 min. or less

▶ This catalog contains the typical specification only due to the limitation of space. When you consider the purchase of our products, please check our specification. For details of each product (characteristics graph, reliability information, precautions for use, and so on), see our Web site (<http://www.ty-top.com/>).

6. Resin coating and mold	
Precautions	<p>1. With some type of resins, decomposition gas or chemical reaction vapor may remain inside the resin during the hardening period or while left under normal storage conditions resulting in the deterioration of the capacitor's performance.</p> <p>2. When a resin's hardening temperature is higher than capacitor's operating temperature, the stresses generated by the excessive heat may lead to damage or destruction of capacitors. The use of such resins, molding materials etc. is not recommended.</p>
7. Handling	
Precautions	<p>◆Splitting of PCB</p> <p>1. When PCBs are split after components mounting, care shall be taken so as not to give any stresses of deflection or twisting to the board.</p> <p>2. Board separation shall not be done manually, but by using the appropriate devices.</p> <p>◆Mechanical considerations</p> <p>Be careful not to subject capacitors to excessive mechanical shocks.</p> <p>(1) If ceramic capacitors are dropped onto a floor or a hard surface, they shall not be used.</p> <p>(2) Please be careful that the mounted components do not come in contact with or bump against other boards or components.</p>
8. Storage conditions	
Precautions	<p>◆Storage</p> <p>1. To maintain the solderability of terminal electrodes and to keep packaging materials in good condition, care must be taken to control temperature and humidity in the storage area. Humidity should especially be kept as low as possible.</p> <p>•Recommended conditions</p> <p>Ambient temperature : Below 30°C Humidity : Below 70% RH</p> <p>The ambient temperature must be kept below 40°C. Even under ideal storage conditions, solderability of capacitor is deteriorated as time passes, so capacitors shall be used within 6 months from the time of delivery.</p> <p>•Ceramic chip capacitors shall be kept where no chlorine or sulfur exists in the air.</p> <p>2. The capacitance values of high dielectric constant capacitors will gradually decrease with the passage of time, so care shall be taken to design circuits. Even if capacitance value decreases as time passes, it will get back to the initial value by a heat treatment at 150°C for 1hour.</p>
Technical considerations	<p>If capacitors are stored in a high temperature and humidity environment, it might rapidly cause poor solderability due to terminal oxidation and quality loss of taping/packaging materials. For this reason, capacitors shall be used within 6 months from the time of delivery. If exceeding the above period, please check solderability before using the capacitors.</p>
<p>※RCR-2335B (Safety Application Guide for fixed ceramic capacitors for use in electronic equipment) is published by JEITA. Please check the guide regarding precautions for deflection test, soldering by spot heat, and so on.</p>	

Mouser Electronics

Authorized Distributor

Click to View Pricing, Inventory, Delivery & Lifecycle Information:

Taiyo Yuden:

[TMK316ABJ106KD-T](#) [LMK042B7101KC-FW](#) [LMK042B7101MC-FW](#) [LMK042B7102KC-FW](#) [LMK042B7102MC-FW](#)
[LMK042B7151KC-FW](#) [LMK042B7151MC-FW](#) [LMK042B7221KC-FW](#) [LMK042B7221MC-FW](#) [LMK042B7331KC-FW](#)
[LMK042B7331MC-FW](#) [LMK042B7471KC-FW](#) [LMK042B7471MC-FW](#) [LMK042B7681KC-FW](#) [LMK042B7681MC-FW](#)
[LMK042BJ101KC-FW](#) [LMK042BJ102KC-FW](#) [LMK042BJ103KC-FW](#) [LMK042BJ103MC-FW](#) [LMK042BJ221KC-FW](#)
[LMK042BJ471KC-FW](#) [LMK063BJ103KP-F](#) [LMK063BJ103MP-F](#) [LMK063BJ104KP-F](#) [LMK063BJ104MP-F](#)
[LMK063BJ152KP-F](#) [LMK063BJ222KP-F](#) [LMK063BJ222MP-F](#) [LMK063BJ223KP-F](#) [LMK063BJ223MP-F](#)
[LMK063BJ224MP-F](#) [LMK063BJ472KP-F](#) [LMK063BJ472MP-F](#) [LMK063BJ473KP-F](#) [LMK063C6273KP-F](#)
[LMK063C6273MP-F](#) [LMK063C6473MP-F](#) [LMK105B7104KV-F](#) [LMK105B7223KV-F](#) [LMK105B7333KV-F](#)
[LMK105B7473KV-F](#) [LMK105BJ104KC-F](#) [LMK105BJ104KV-F](#) [LMK105BJ104MV-F](#) [LMK105BJ105KV-F](#)
[LMK105BJ105MV-F](#) [LMK105BJ224KV-F](#) [LMK105BJ225MV-F](#) [LMK105BJ474KV-F](#) [LMK105BJ683KV-F](#)
[LMK105BJ683MV-F](#) [LMK105BJ823MV-F](#) [LMK105F223ZV-F](#) [LMK105F224ZV-F](#) [LMK105F473ZV-F](#)
[LMK105SD332JV-F](#) [LMK105SD332KV-F](#) [LMK105SD392JV-F](#) [LMK105SD392KV-F](#) [LMK105SD472JV-F](#)
[LMK105SD472KV-F](#) [LMK107B7105KA-T](#) [LMK107B7105MA-T](#) [LMK107B7154KA-T](#) [LMK107B7154MA-T](#)
[LMK107B7224KA-T](#) [LMK107B7224MA-T](#) [LMK107B7225KA-T](#) [LMK107B7334KA-T](#) [LMK107B7334MA-T](#)
[LMK107B7474KA-T](#) [LMK107B7474MA-T](#) [LMK107BJ105KA-T](#) [LMK107BJ105KK-T](#) [LMK107BJ105MA-T](#)
[LMK107BJ105MK-T](#) [LMK107BJ106MALTD](#) [LMK107BJ225KA-T](#) [LMK107BJ225MA-T](#) [LMK107BJ335KA-T](#)
[LMK107BJ475KA-T](#) [LMK107BJ684KA-T](#) [LMK107BJ684MA-T](#) [LMK107F105ZA-T](#) [LMK107F225ZA-T](#)
[LMK107SD123JA-T](#) [LMK107SD123KA-T](#) [LMK107SD153JA-T](#) [LMK107SD153KA-T](#) [LMK107SD183JA-T](#)
[LMK107SD183KA-T](#) [LMK107SD223JA-T](#) [LMK107SD223KA-T](#) [LMK212B7105KD-T](#) [LMK212B7105KG-T](#)
[LMK212B7105MD-T](#) [LMK212B7105MG-T](#) [LMK212B7106KG-TD](#) [LMK212B7225KD-T](#) [LMK212B7225KG-T](#)