



## 200MHz, CMOS OPERATIONAL AMPLIFIER

### FEATURES

- UNITY-GAIN BANDWIDTH: 450MHz
- WIDE BANDWIDTH: 200MHz GBW
- HIGH SLEW RATE: 360V/ $\mu$ s
- LOW NOISE: 5.8nV/ $\sqrt{\text{Hz}}$
- EXCELLENT VIDEO PERFORMANCE:  
DIFF GAIN: 0.02%, DIFF PHASE: 0.05°  
0.1dB GAIN FLATNESS: 75MHz
- INPUT RANGE INCLUDES GROUND
- RAIL-TO-RAIL OUTPUT (within 100mV)
- LOW INPUT BIAS CURRENT: 3pA
- THERMAL SHUTDOWN
- SINGLE-SUPPLY OPERATING RANGE: 2.5V to 5.5V
- *Micro*SIZE PACKAGES

### APPLICATIONS

- VIDEO PROCESSING
- ULTRASOUND
- OPTICAL NETWORKING, TUNABLE LASERS
- PHOTODIODE TRANSIMPEDANCE AMPS
- ACTIVE FILTERS
- HIGH-SPEED INTEGRATORS
- ANALOG-TO-DIGITAL (A/D) CONVERTER  
INPUT BUFFERS
- DIGITAL-TO-ANALOG (D/A) CONVERTER  
OUTPUT AMPLIFIERS
- BARCODE SCANNERS
- COMMUNICATIONS

### DESCRIPTION

The OPAx356 series high-speed, voltage-feedback CMOS operational amplifiers are designed for video and other applications requiring wide bandwidth. The OPAx356 is unity gain stable and can drive large output currents. Differential gain is 0.02% and differential phase is 0.05°. Quiescent current is only 8.3mA per channel.

OPAx356 is optimized for operation on single or dual supplies as low as 2.5V ( $\pm 1.25\text{V}$ ) and up to 5.5V ( $\pm 2.75\text{V}$ ). Common-mode input range for the OPAx356 extends 100mV below ground and up to 1.5V from V+. The output swing is within 100mV of the rails, supporting wide dynamic range.

The OPAx356 series is available in single (SOT23-5 and SO-8), and dual (MSOP-8 and SO-8) versions. Multichannel versions feature completely independent circuitry for lowest crosstalk and freedom from interaction. All are specified over the extended  $-40^{\circ}\text{C}$  to  $+125^{\circ}\text{C}$  range.

### OPAx356 RELATED PRODUCTS

FEATURES	PRODUCT
200MHz, Rail-to-Rail Output, CMOS, Shutdown	OPAx355
38MHz, Rail-to-Rail Input/Output, CMOS	OPAx350
75MHz, Rail-to-Rail Output	OPAx631
150MHz, Rail-to-Rail Output	OPAx634
Differential Input/Output, 3.3V Supply	THS412x

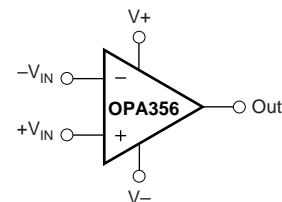

Please be aware that an important notice concerning availability, standard warranty, and use in critical applications of Texas Instruments semiconductor products and disclaimers thereto appears at the end of this data sheet.

## ABSOLUTE MAXIMUM RATINGS<sup>(1)</sup>

Supply Voltage, V+ to V- .....	7.5V
Signal Input Terminals, Voltage <sup>(2)</sup> .....	(V-) - 0.5V to (V+) + 0.5V
Current <sup>(2)</sup> .....	10mA
Output Short-Circuit <sup>(3)</sup> .....	Continuous
Operating Temperature .....	-55°C to +150°C
Storage Temperature .....	-65°C to +150°C
Junction Temperature .....	+160°C
Lead Temperature (soldering, 10s) .....	+300°C

NOTE: (1) Stresses above these ratings may cause permanent damage. Exposure to absolute maximum conditions for extended periods may degrade device reliability. These are stress ratings only, and functional operation of the device at these or any other conditions beyond those specified is not implied. (2) Input terminals are diode-clamped to the power-supply rails. Input signals that can swing more than 0.5V beyond the supply rails should be current limited to 10mA or less. (3) Short-circuit to ground one amplifier per package.



## ELECTROSTATIC DISCHARGE SENSITIVITY

This integrated circuit can be damaged by ESD. Texas Instruments recommends that all integrated circuits be handled with appropriate precautions. Failure to observe proper handling and installation procedures can cause damage.

ESD damage can range from subtle performance degradation to complete device failure. Precision integrated circuits may be more susceptible to damage because very small parametric changes could cause the device not to meet its published specifications.

## PACKAGE/ORDERING INFORMATION

PRODUCT	PACKAGE-LEAD	PACKAGE DESIGNATOR <sup>(1)</sup>	SPECIFIED TEMPERATURE RANGE	PACKAGE MARKING	ORDERING NUMBER <sup>(2)</sup>	TRANSPORT MEDIA, QUANTITY
OPA356AIDBV	SOT23-5	DBV	-40°C to +125°C	OAAI	OPA356AIDBVT	Tape and Reel, 250
"	"	"	"	"	OPA356AIDBVR	Tape and Reel, 3000
OPA356AID	SO-8	D	-40°C to +125°C	OPA356A	OPA356AID	Rails, 100
"	"	"	"	"	OPA356AIDR	Tape and Reel, 2500
OPA2356AIDGK	MSOP-8	DGK	-40°C to +125°C	AYI	OPA2356AIDGKT	Tape and Reel, 250
"	"	"	"	"	OPA2356AIDGKR	Tape and Reel, 2500
OPA2356AID	SO-8	D	-40°C to +125°C	OPA2356A	OPA2356AID	Rails, 100
"	"	"	"	"	OPA2356AIDR	Tape and Reel, 2500

NOTES: (1) For the most current specifications and package information, refer to our web site at [www.ti.com](http://www.ti.com). (2) Models labeled with "T" indicate smaller quantity tape and reel, "R" indicates large quantity tape and reel and "D" indicates rails of specified quantity.

## PIN CONFIGURATIONS

Top View

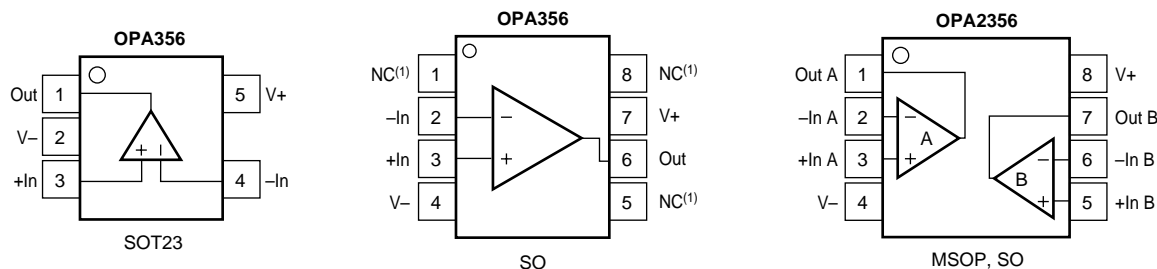

NOTE: (1) NC means no internal connection.

# ELECTRICAL CHARACTERISTICS: $V_S = +2.7V$ to $+5.5V$ Single Supply

**Boldface** limits apply over the specified temperature range,  $T_A = -40^\circ C$  to  $+125^\circ C$ .

At  $T_A = +25^\circ C$ ,  $R_F = 604\Omega$ ,  $R_L = 150\Omega$ , Connected to  $V_S/2$ , unless otherwise noted.

PARAMETER	CONDITION	OPA356AIDBV, AID, OPA2356AIDGK, AID			UNITS
		MIN	TYP	MAX	
<b>OFFSET VOLTAGE</b>					
Input Offset Voltage	$V_{OS}$		$\pm 2$	$\pm 9$	mV
<b>vs Temperature</b>	$dV_{OS}/dT$		$\pm 7$	$\pm 15$	mV/ $^\circ C$
<b>vs Power Supply</b>	PSRR	$V_S = +2.7V$ to $+5.5V$ , $V_{CM} = V_S/2 - 0.15V$	$\pm 80$	$\pm 350$	$\mu V/V$
<b>INPUT BIAS CURRENT</b>					
Input Bias Current	$I_B$		3	$\pm 50$	pA
Input Offset Current	$I_{OS}$		$\pm 1$	$\pm 50$	pA
<b>NOISE</b>					
Input Noise Voltage Density	$e_n$	$f = 1MHz$	5.8		$nV/\sqrt{Hz}$
Current Noise Density	$i_n$	$f = 1MHz$	50		$fA/\sqrt{Hz}$
<b>INPUT VOLTAGE RANGE</b>					
Common-Mode Voltage Range	$V_{CM}$		$(V-) - 0.1$	$(V+) - 1.5$	V
Common-Mode Rejection Ratio	CMRR	$V_S = +5.5V$ , $-0.1V < V_{CM} < +4.0V$	66	80	dB
		<b>Specified Temperature Range</b>	<b>66</b>		<b>dB</b>
<b>INPUT IMPEDANCE</b>					
Differential			$10^{13} \parallel 1.5$		$\Omega \parallel pF$
Common-Mode			$10^{13} \parallel 1.5$		$\Omega \parallel pF$
<b>OPEN-LOOP GAIN</b>					
	<b>OPA356</b>	$V_S = +5V$ , $0.3V < V_O < 4.7V$	84	92	dB
	<b>OPA2356</b>	$V_S = +5V$ , $0.3V < V_O < 4.7V$	<b>80</b>		<b>dB</b>
		$V_S = +5V$ , $0.4V < V_O < 4.6V$	<b>80</b>		<b>dB</b>
<b>FREQUENCY RESPONSE</b>					
Small-Signal Bandwidth	$f_{-3dB}$	$G = +1$ , $V_O = 100mVp-p$ , $R_F = 0\Omega$	450		MHz
	$f_{-3dB}$	$G = +2$ , $V_O = 100mVp-p$ , $R_L = 50\Omega$	100		MHz
	$f_{-3dB}$	$G = +2$ , $V_O = 100mVp-p$ , $R_L = 150\Omega$	170		MHz
	$f_{-3dB}$	$G = +2$ , $V_O = 100mVp-p$ , $R_L = 1k\Omega$	200		MHz
Gain-Bandwidth Product	GBW	$G = +10$ , $R_L = 1k\Omega$	200		MHz
Bandwidth for 0.1dB Gain Flatness	$f_{0.1dB}$	$G = +2$ , $V_O = 100mVp-p$ , $R_F = 560\Omega$	75		MHz
Slew Rate	SR	$V_S = +5V$ , $G = +2$ , 4V Output Step	300/-360		V/ $\mu s$
Rise-and-Fall Time		$G = +2$ , $V_O = 200mVp-p$ , 10% to 90%	2.4		ns
		$G = +2$ , $V_O = 2Vp-p$ , 10% to 90%	8		ns
Settling Time, 0.1%		$V_S = +5V$ , $G = +2$ , 2V Output Step	30		ns
0.01%		$V_S = +5V$ , $G = +2$ , 2V Output Step	120		ns
Overload Recovery Time		$V_{IN} \cdot Gain = V_S$	8		ns
Harmonic Distortion					
2 <sup>nd</sup> Harmonic		$G = +2$ , $f = 1MHz$ , $V_O = 2Vp-p$ , $R_L = 200\Omega$	-81		dBc
3 <sup>rd</sup> Harmonic		$G = +2$ , $f = 1MHz$ , $V_O = 2Vp-p$ , $R_L = 200\Omega$	-93		dBc
Differential Gain Error		NTSC, $R_L = 150\Omega$	0.02		%
Differential Phase Error		NTSC, $R_L = 150\Omega$	0.05		degrees
Channel-to-Channel Crosstalk	OPA2356	$f = 5MHz$	-90		dB
<b>OUTPUT</b>					
Voltage Output Swing from Rail		$V_S = +5V$ , $R_L = 150\Omega$ , $A_{OL} > 84dB$	0.2	0.3	V
Voltage Output Swing from Rail		$V_S = +5V$ , $R_L = 1k\Omega$	0.1		V
Voltage Output Swing from Rail		$I_O = \pm 100mA$	0.8	1	V
Output Current, Continuous <sup>(1)</sup>	$I_O$		$\pm 60$		mA
Maximum Output Current, Peak <sup>(1)</sup>	$I_O$	$V_S = +5V$	$\pm 100$		mA
Maximum Output Current, Peak <sup>(1)</sup>	$I_O$	$V_S = +3V$		$\pm 80$	mA
Short Circuit Current				+250/-200	mA
Closed-Loop Output Impedance		$f < 100kHz$		0.02	$\Omega$
<b>POWER SUPPLY</b>					
Specified Voltage Range	$V_S$		2.7	5.5	V
Operating Voltage Range				2.5 to 5.5	V
Quiescent Current (per amplifier)	$I_Q$	$V_S = +5V$ , $I_O = 0$		8.3	mA
		<b>Specified Temperature Range</b>		<b>14</b>	<b>mA</b>

# ELECTRICAL CHARACTERISTICS: $V_S = +2.7V$ to $+5.5V$ Single Supply (Cont.)

**Boldface** limits apply over the specified temperature range,  $T_A = -40^{\circ}C$  to  $+125^{\circ}C$ .

At  $T_A = +25^{\circ}C$ ,  $R_F = 604\Omega$ ,  $R_L = 150\Omega$ , Connected to  $V_S/2$ , unless otherwise noted.

PARAMETER	CONDITION	OPA356AIDBV, AID, OPA2356AIDGK, AID			UNITS
		MIN	TYP	MAX	
<b>THERMAL SHUTDOWN</b>					
Junction Temperature					
Shutdown			160		$^{\circ}C$
Reset from Shutdown			140		$^{\circ}C$
<b>TEMPERATURE RANGE</b>					
Specified Range		-40		125	$^{\circ}C$
Operating Range		-55		150	$^{\circ}C$
Storage Range		-65		150	$^{\circ}C$
Thermal Resistance	$\theta_{JA}$				$^{\circ}C/W$
SOT23-5, MSOP-8			150		$^{\circ}C/W$
SO-8			125		$^{\circ}C/W$

NOTES: (1) See typical characteristic "Output Voltage Swing vs Output Current".

# TYPICAL CHARACTERISTICS

At  $T_A = +25^\circ\text{C}$  and  $V_S = 5\text{V}$ ,  $G = +2$ ,  $R_F = 604\Omega$ ,  $R_L = 150\Omega$  connected to  $V_S/2$ , unless otherwise noted.

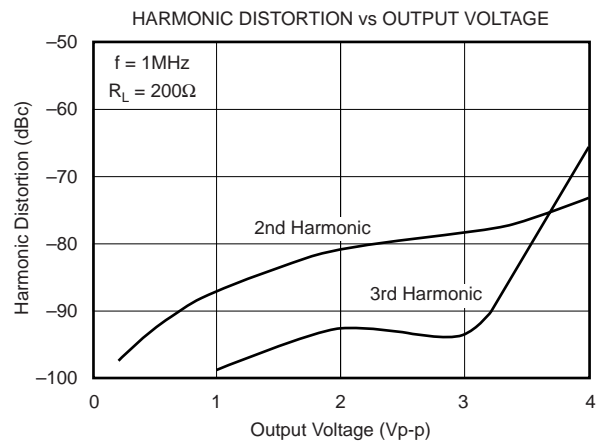
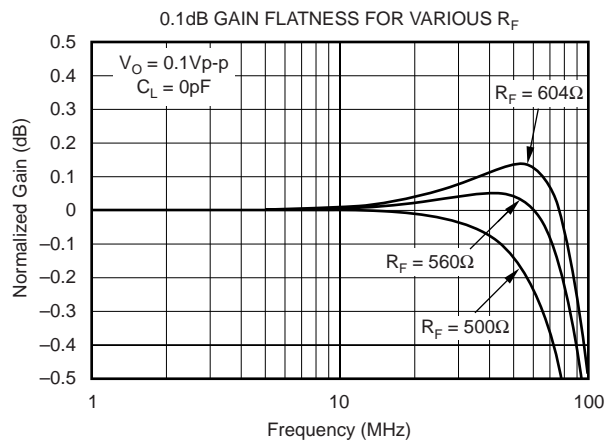
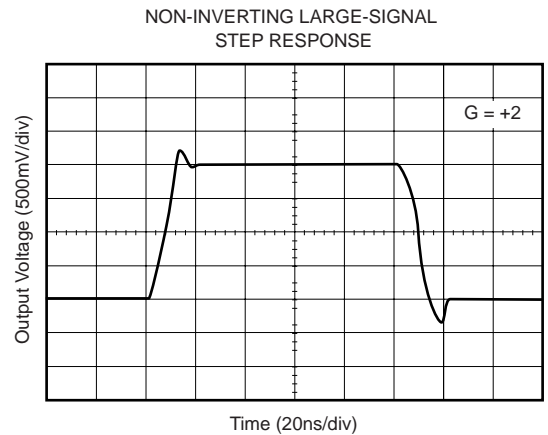
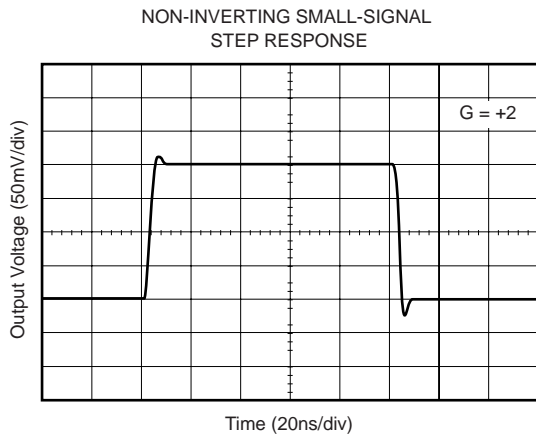
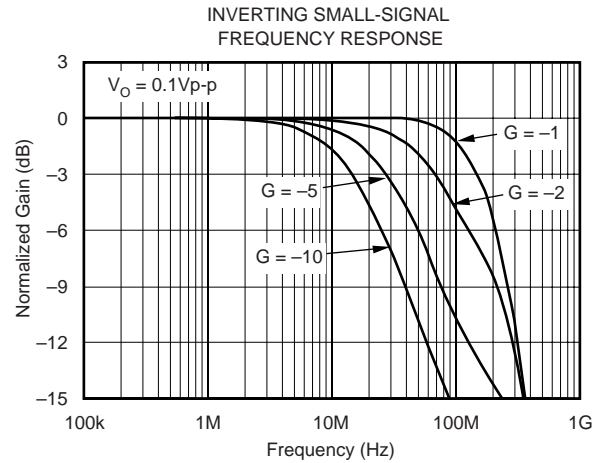
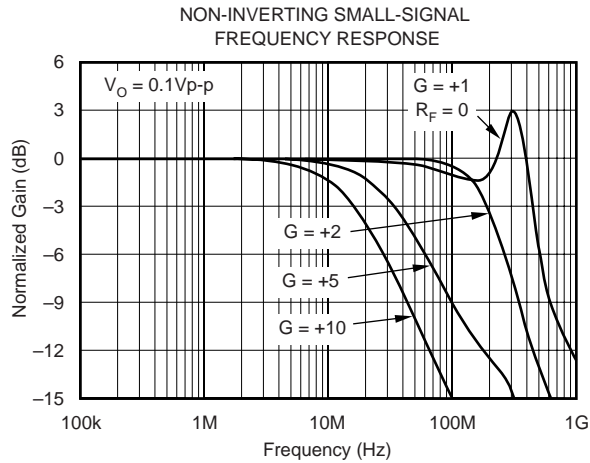

# TYPICAL CHARACTERISTICS (Cont.)

At  $T_A = +25^\circ\text{C}$  and  $V_S = 5\text{V}$ ,  $G = +2$ ,  $R_F = 604\Omega$ ,  $R_L = 150\Omega$  connected to  $V_S/2$ , unless otherwise noted.

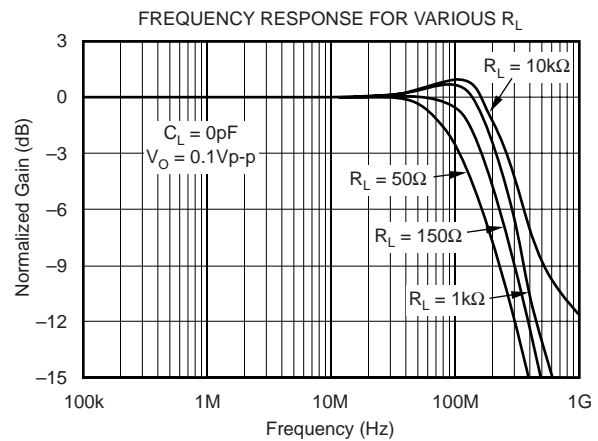
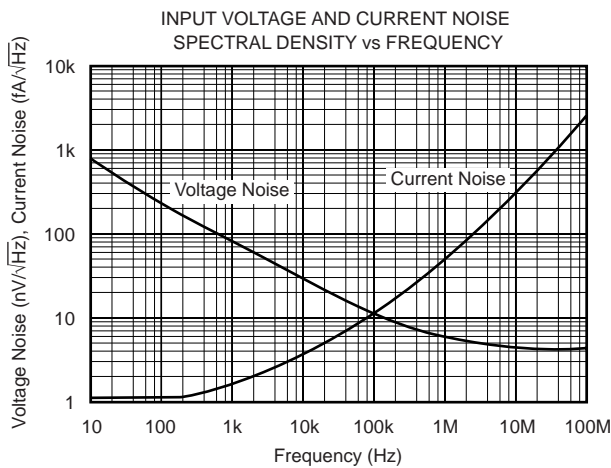
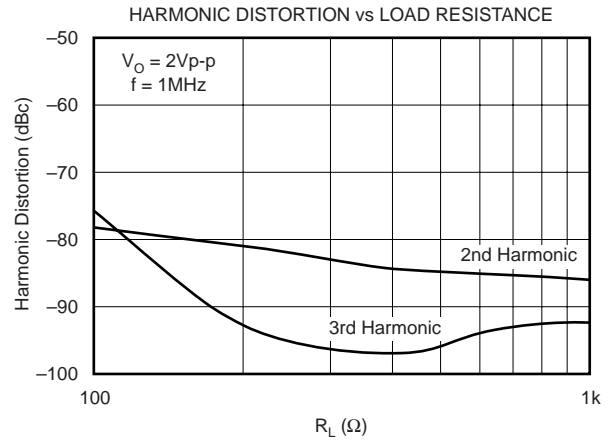
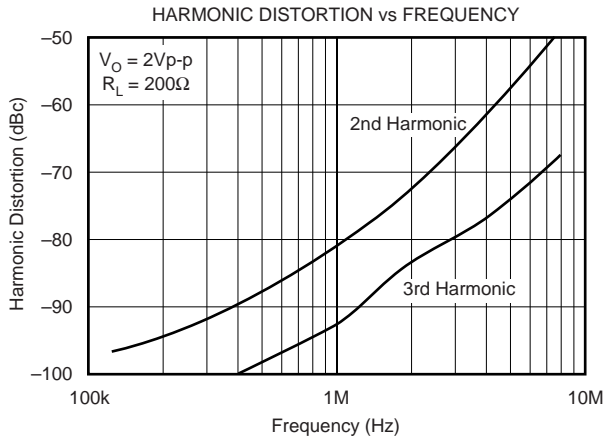
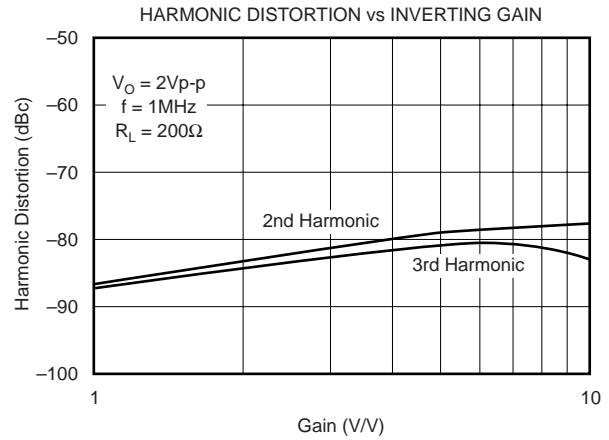
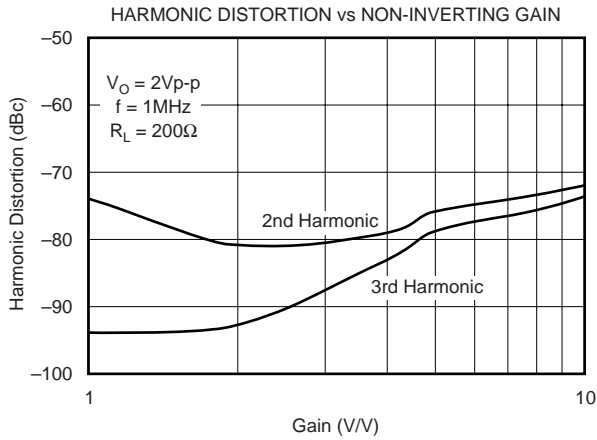

# TYPICAL CHARACTERISTICS (Cont.)

At  $T_A = +25^\circ\text{C}$  and  $V_S = 5\text{V}$ ,  $G = +2$ ,  $R_F = 604\Omega$ ,  $R_L = 150\Omega$  connected to  $V_S/2$ , unless otherwise noted.

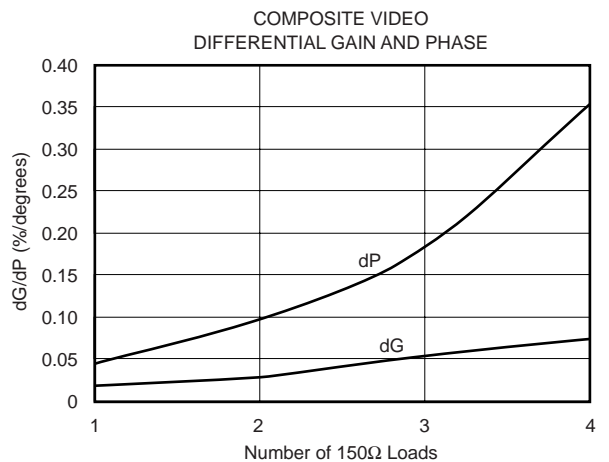
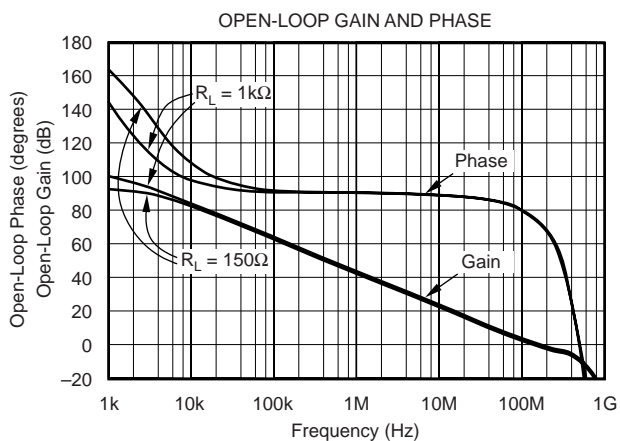
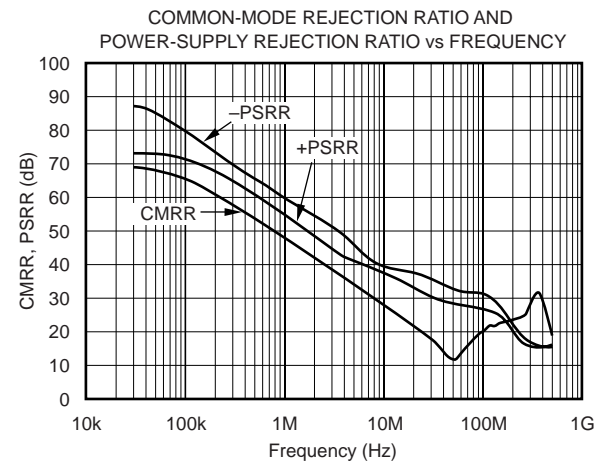
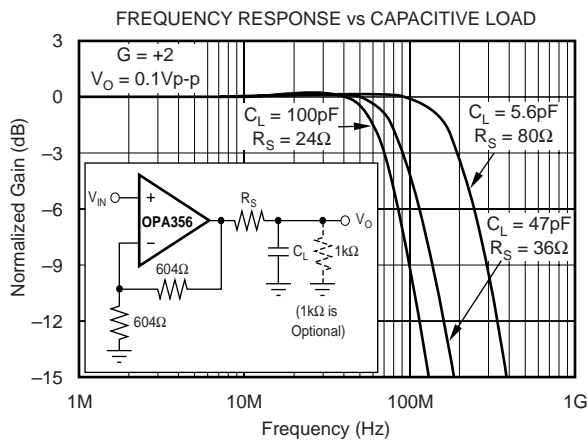
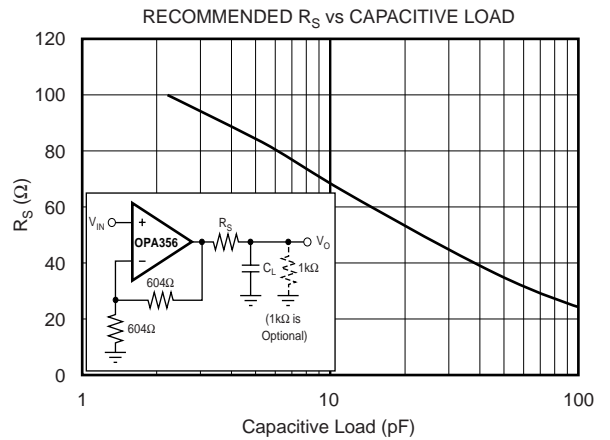
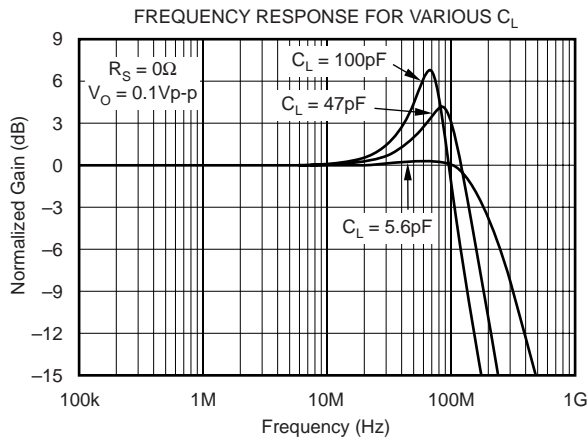

# TYPICAL CHARACTERISTICS (Cont.)

At  $T_A = +25^\circ\text{C}$  and  $V_S = 5\text{V}$ ,  $G = +2$ ,  $R_F = 604\Omega$ ,  $R_L = 150\Omega$  connected to  $V_S/2$ , unless otherwise noted.

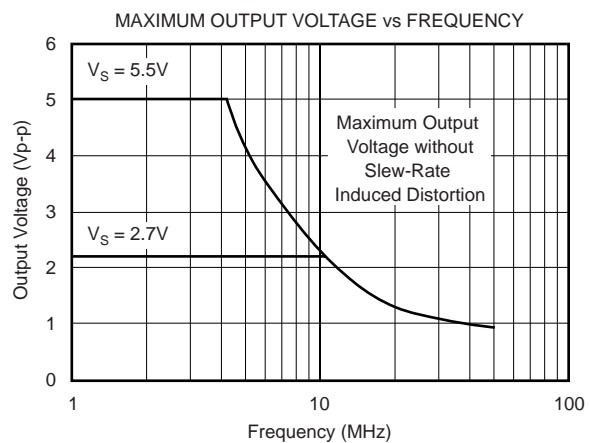
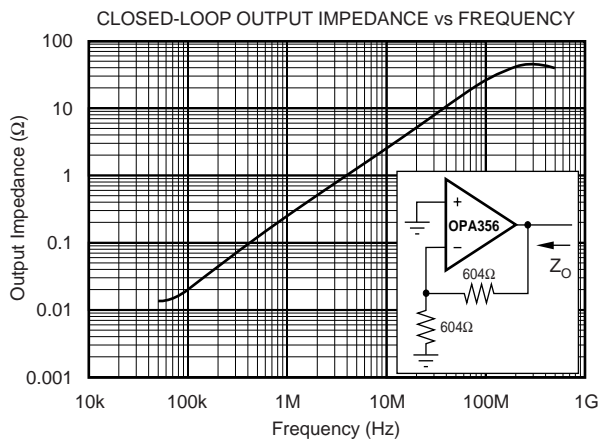
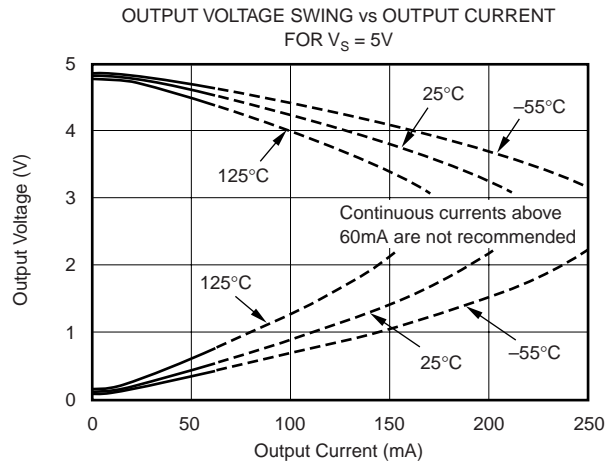
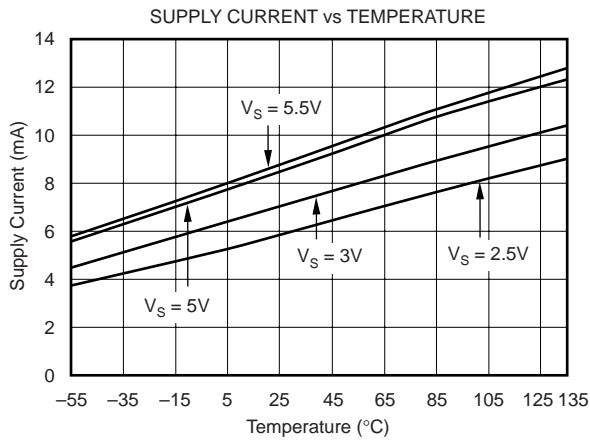
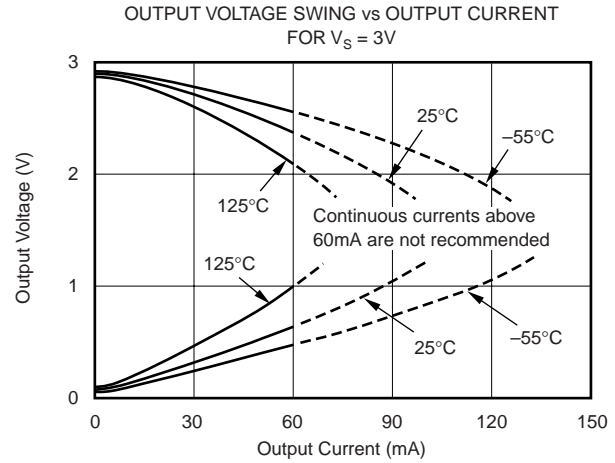
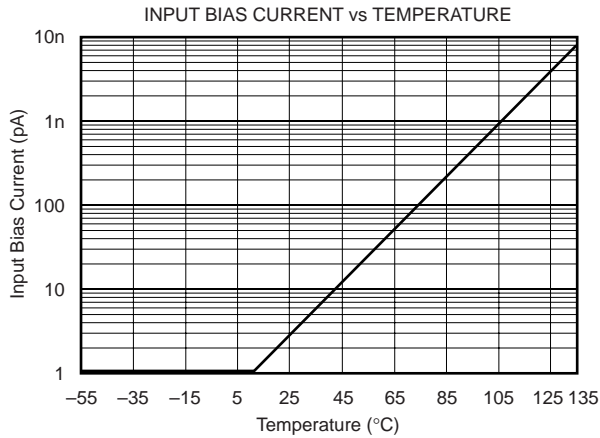



# TYPICAL CHARACTERISTICS (Cont.)

At  $T_A = +25^\circ\text{C}$  and  $V_S = 5\text{V}$ ,  $G = +2$ ,  $R_F = 604\Omega$ ,  $R_L = 150\Omega$  connected to  $V_S/2$ , unless otherwise noted.

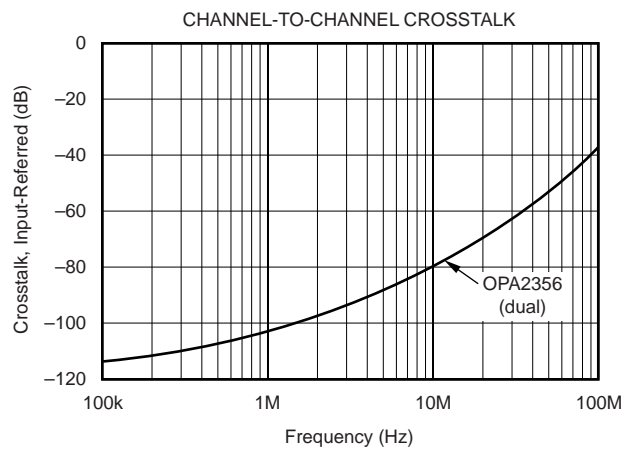
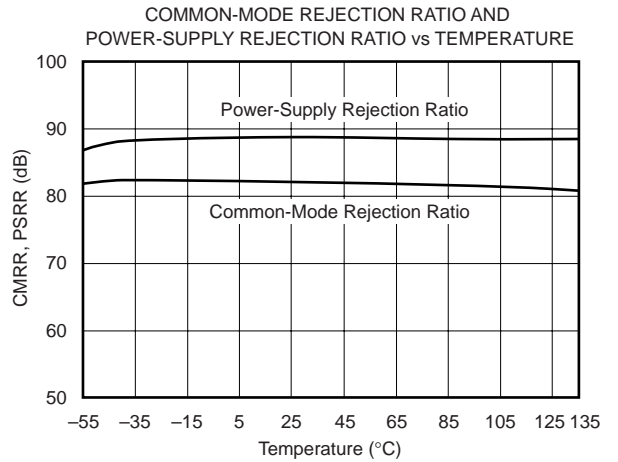
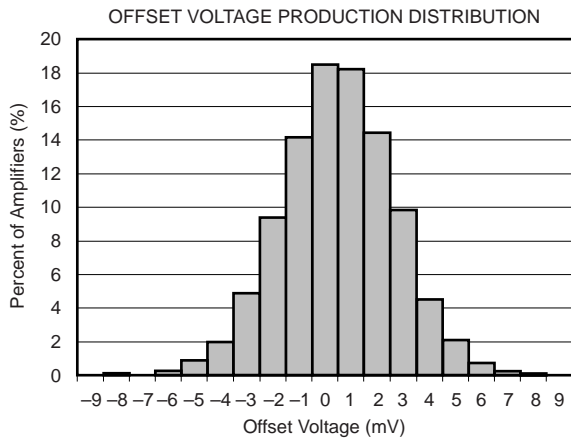
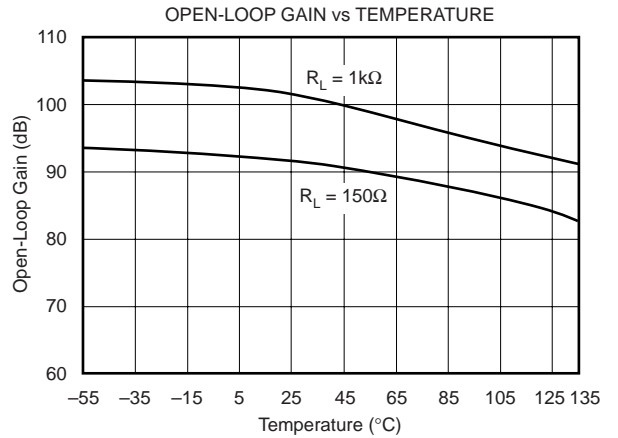
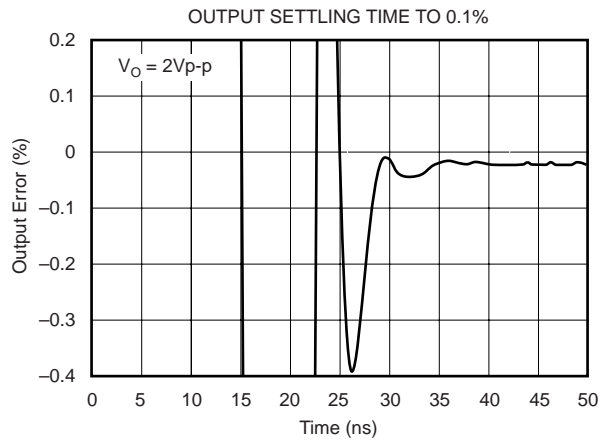

## APPLICATIONS INFORMATION

The OPAx356 series is a CMOS, high-speed, voltage feed-back, operational amplifier designed for video and other general-purpose applications. It is available as a single or dual op amp.

The amplifier features a 200MHz gain bandwidth and 360V/ $\mu$ s slew rate, but it is unity-gain stable and can be operated as a +1V/V voltage follower.

Its input common-mode voltage range includes ground, allowing the OPAx356 to be used in virtually any single-supply application up to a supply voltage of +5.5V.

### PCB LAYOUT

Good high-frequency PC board layout techniques should be employed for the OPAx356. Generous use of ground planes, short direct signal traces, and a suitable bypass capacitor located at the V+ pin will assure clean, stable operation. Large areas of copper also provide a means of dissipating heat that is generated within the amplifier in normal operation.

Sockets are definitely not recommended for use with any high-speed amplifier.

A 10 $\mu$ F ceramic bypass capacitor is the minimum recommended value; adding a 1 $\mu$ F or larger tantalum capacitor in parallel can be beneficial when driving a low-resistance load. Providing adequate bypass capacitance is essential to achieving very low harmonic and intermodulation distortion.

### OPERATING VOLTAGE

The OPAx356 is specified over a power-supply range of +2.7V to +5.5V ( $\pm 1.35$  to  $\pm 2.75$ V). However, the supply voltage may range from +2.5V to +5.5V ( $\pm 1.25$ V to  $\pm 2.75$ V). Supply voltages higher than 7.5V (absolute maximum) can permanently damage the amplifier.

Parameters that vary significantly over supply voltage or temperature are shown in the "Typical Characteristics" section of this data sheet.

### OUTPUT DRIVE

The OPAx356 output stage is capable of driving a standard back-terminated 75 $\Omega$  video cable. By back-terminating a transmission line, it does not exhibit a capacitive load to its driver. A properly back-terminated 75 $\Omega$  cable does not appear as capacitance; it presents only a 150 $\Omega$  resistive load to the OPAx356 output.

The output stage can supply high short-circuit current (typically over 200mA). Therefore, an on-chip thermal shutdown circuit is provided to protect the OPAx356 from dangerously high junction temperatures. At 160 $^{\circ}$ C, the protection circuit will shut down the amplifier. Normal operation will resume when the junction temperature cools to below 140 $^{\circ}$ C.

NOTE: It is not recommended to run a continuous DC current in excess of  $\pm 60$ mA. Refer to the graph of "Output Voltage Swing vs Output Current", shown in the "Typical Characteristics" section of this data sheet.

### INPUT AND ESD PROTECTION

All OPAx356 pins are static protected with internal ESD protection diodes tied to the supplies, as shown in Figure 1.

These diodes will provide overdrive protection if the current is externally limited to 10mA by the source or by a resistor.

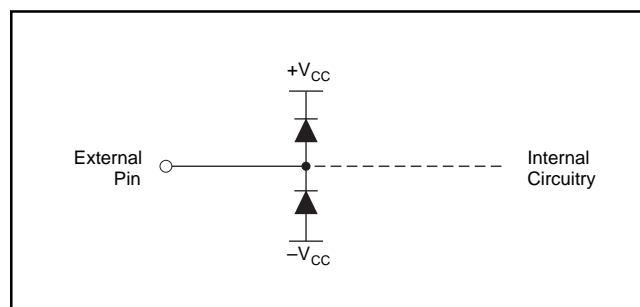
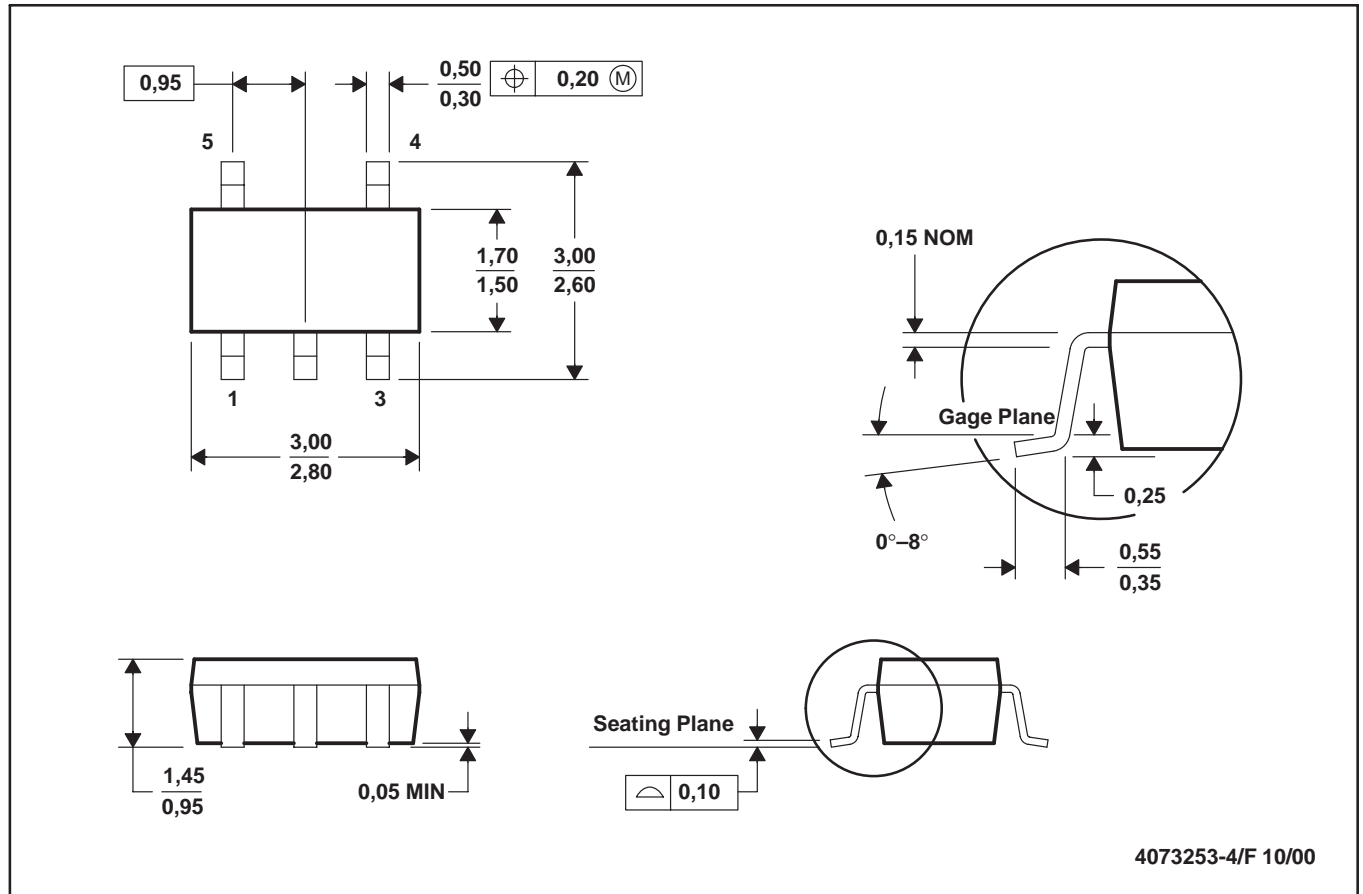

FIGURE 1. Internal ESD Protection.

DBV (R-PDSO-G5)

PLASTIC SMALL-OUTLINE



- NOTES: A. All linear dimensions are in millimeters.  
 B. This drawing is subject to change without notice.  
 C. Body dimensions do not include mold flash or protrusion.  
 D. Falls within JEDEC MO-178

DGK (R-PDSO-G8)

PLASTIC SMALL-OUTLINE PACKAGE

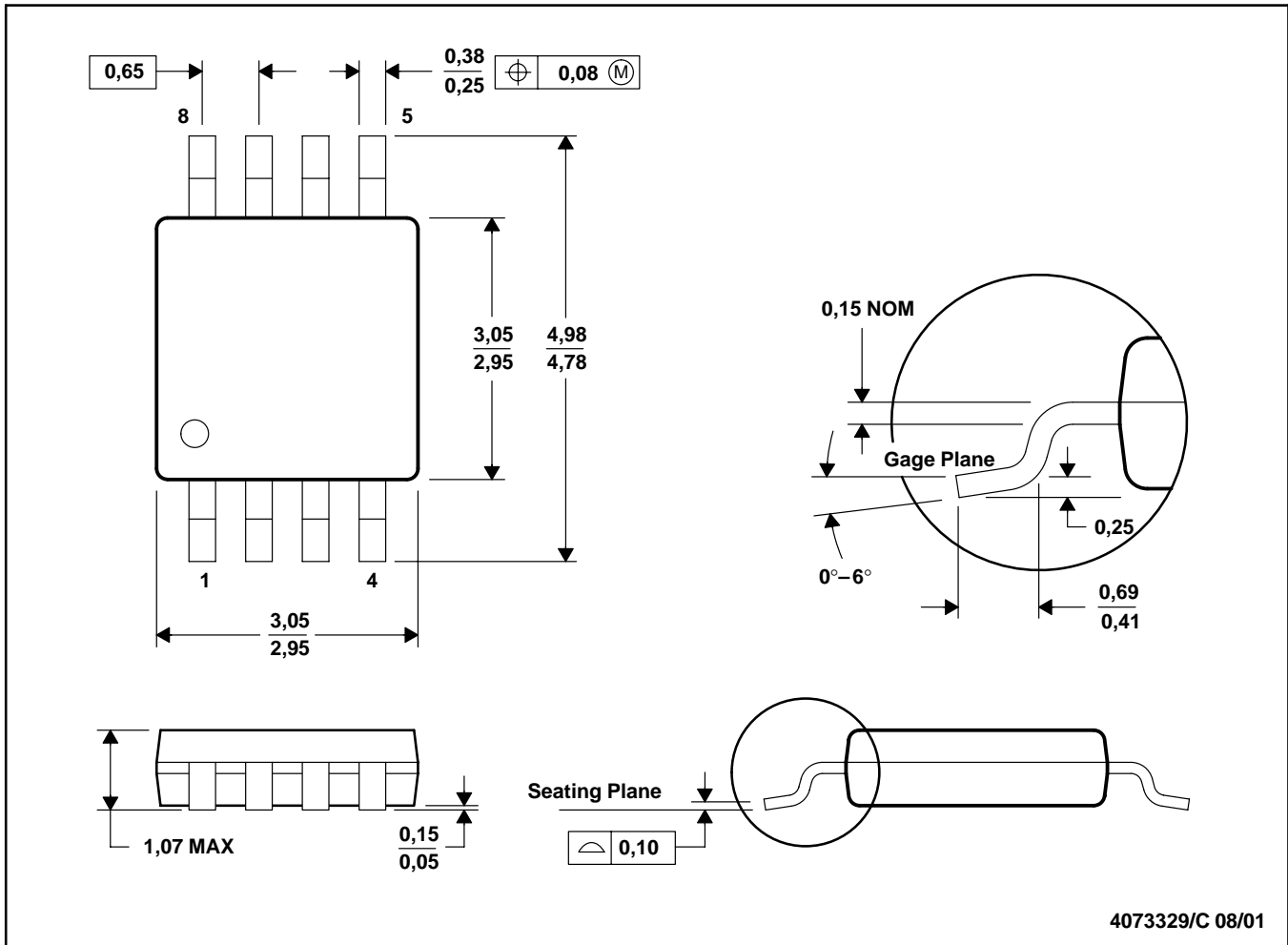

- NOTES:
- A. All linear dimensions are in millimeters.
  - B. This drawing is subject to change without notice.
  - C. Body dimensions do not include mold flash or protrusion.
  - D. Falls within JEDEC MO-187

D (R-PDSO-G\*\*)

PLASTIC SMALL-OUTLINE PACKAGE

8 PINS SHOWN

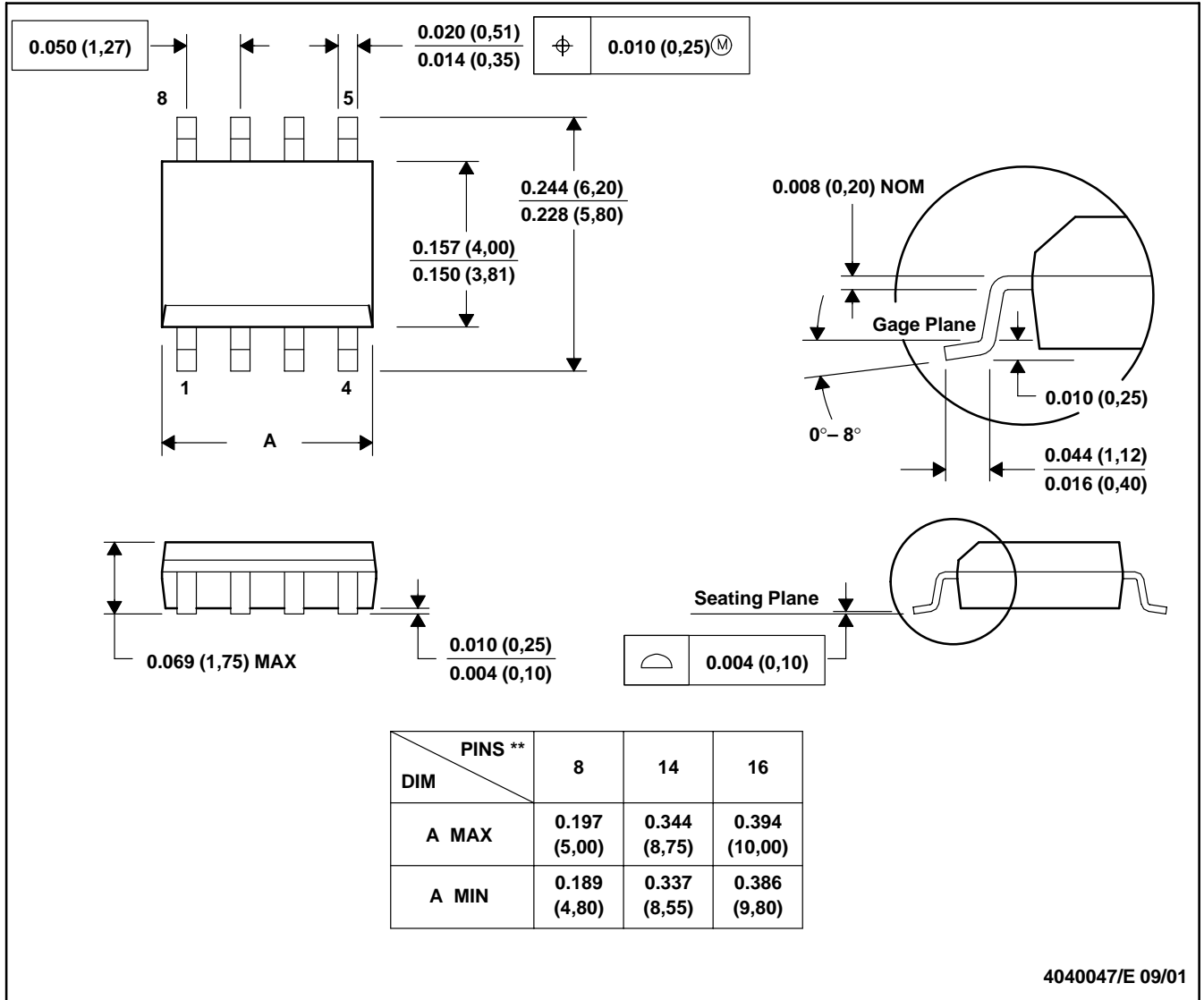

- NOTES: A. All linear dimensions are in inches (millimeters).  
 B. This drawing is subject to change without notice.  
 C. Body dimensions do not include mold flash or protrusion, not to exceed 0.006 (0,15).  
 D. Falls within JEDEC MS-012

**PACKAGING INFORMATION**

ORDERABLE DEVICE	STATUS(1)	PACKAGE TYPE	PACKAGE DRAWING	PINS	PACKAGE QTY
OPA2356AID	ACTIVE	SOIC	D	8	100
OPA2356AIDGKR	ACTIVE	VSSOP	DGK	8	2500
OPA2356AIDGKT	ACTIVE	VSSOP	DGK	8	250
OPA2356AIDR	ACTIVE	SOIC	D	8	2500
OPA356AID	ACTIVE	SOIC	D	8	100
OPA356AIDBVR	ACTIVE	SOP	DBV	5	3000
OPA356AIDBVT	ACTIVE	SOP	DBV	5	250
OPA356AIDR	ACTIVE	SOIC	D	8	2500

(1) The marketing status values are defined as follows:

**ACTIVE:** Product device recommended for new designs.

**LIFEBUY:** TI has announced that the device will be discontinued, and a lifetime-buy period is in effect.

**NRND:** Not recommended for new designs. Device is in production to support existing customers, but TI does not recommend using this part in a new design.

**PREVIEW:** Device has been announced but is not in production. Samples may or may not be available.

**OBSOLETE:** TI has discontinued the production of the device.

## IMPORTANT NOTICE

Texas Instruments Incorporated and its subsidiaries (TI) reserve the right to make corrections, modifications, enhancements, improvements, and other changes to its products and services at any time and to discontinue any product or service without notice. Customers should obtain the latest relevant information before placing orders and should verify that such information is current and complete. All products are sold subject to TI's terms and conditions of sale supplied at the time of order acknowledgment.

TI warrants performance of its hardware products to the specifications applicable at the time of sale in accordance with TI's standard warranty. Testing and other quality control techniques are used to the extent TI deems necessary to support this warranty. Except where mandated by government requirements, testing of all parameters of each product is not necessarily performed.

TI assumes no liability for applications assistance or customer product design. Customers are responsible for their products and applications using TI components. To minimize the risks associated with customer products and applications, customers should provide adequate design and operating safeguards.

TI does not warrant or represent that any license, either express or implied, is granted under any TI patent right, copyright, mask work right, or other TI intellectual property right relating to any combination, machine, or process in which TI products or services are used. Information published by TI regarding third-party products or services does not constitute a license from TI to use such products or services or a warranty or endorsement thereof. Use of such information may require a license from a third party under the patents or other intellectual property of the third party, or a license from TI under the patents or other intellectual property of TI.

Reproduction of information in TI data books or data sheets is permissible only if reproduction is without alteration and is accompanied by all associated warranties, conditions, limitations, and notices. Reproduction of this information with alteration is an unfair and deceptive business practice. TI is not responsible or liable for such altered documentation.

Resale of TI products or services with statements different from or beyond the parameters stated by TI for that product or service voids all express and any implied warranties for the associated TI product or service and is an unfair and deceptive business practice. TI is not responsible or liable for any such statements.

Following are URLs where you can obtain information on other Texas Instruments products and application solutions:

<b>Products</b>		<b>Applications</b>	
Amplifiers	<a href="http://amplifier.ti.com">amplifier.ti.com</a>	Audio	<a href="http://www.ti.com/audio">www.ti.com/audio</a>
Data Converters	<a href="http://dataconverter.ti.com">dataconverter.ti.com</a>	Automotive	<a href="http://www.ti.com/automotive">www.ti.com/automotive</a>
DSP	<a href="http://dsp.ti.com">dsp.ti.com</a>	Broadband	<a href="http://www.ti.com/broadband">www.ti.com/broadband</a>
Interface	<a href="http://interface.ti.com">interface.ti.com</a>	Digital Control	<a href="http://www.ti.com/digitalcontrol">www.ti.com/digitalcontrol</a>
Logic	<a href="http://logic.ti.com">logic.ti.com</a>	Military	<a href="http://www.ti.com/military">www.ti.com/military</a>
Power Mgmt	<a href="http://power.ti.com">power.ti.com</a>	Optical Networking	<a href="http://www.ti.com/opticalnetwork">www.ti.com/opticalnetwork</a>
Microcontrollers	<a href="http://microcontroller.ti.com">microcontroller.ti.com</a>	Security	<a href="http://www.ti.com/security">www.ti.com/security</a>
		Telephony	<a href="http://www.ti.com/telephony">www.ti.com/telephony</a>
		Video & Imaging	<a href="http://www.ti.com/video">www.ti.com/video</a>
		Wireless	<a href="http://www.ti.com/wireless">www.ti.com/wireless</a>

Mailing Address: Texas Instruments  
Post Office Box 655303 Dallas, Texas 75265

Copyright © 2003, Texas Instruments Incorporated