

IL205A/206A/207/208A SMALL OUTLINE SURFACE MOUNT PHOTOTRANSISTOR OPTOCOUPLER

FEATURES

- High Current Transfer Ratio, $I_F=10\text{ mA}$, $V_{CE}=5\text{ V}$
IL205A, 40–80%
IL206A, 63–125%
IL207A, 100–200%
IL208A, 160–320%
- High BV_{CEO} , 70 V
- Isolation Test Voltage, 2500 VAC_{RMS}
- Industry Standard SOIC-8 Surface Mountable Package
- Standard Lead Spacing, .05"
- Available in Tape and Reel Option—Suffix "T" (Conforms to EIA Standard RS481A)
- Compatible with Dual Wave, Vapor Phase and IR Reflow Soldering
- Underwriters Lab File #E52744 (Code Letter P)

DESCRIPTION

The IL205A/206A/207A/208A are optically coupled pairs with a Gallium Arsenide infrared LED and a silicon NPN phototransistor. Signal information, including a DC level, can be transmitted by the device while maintaining a high degree of electrical isolation between input and output. The IL205/6/7/8 come in a standard SOIC-8 small outline package for surface mounting which makes them ideally suited for high density applications with limited space. In addition to eliminating through-holes requirements, this package conforms to standards for surface mounted devices.

A specified minimum and maximum CTR allows a narrow tolerance in the electrical design of the adjacent circuits. The high BV_{CEO} of 70 volts gives a higher safety margin compared to the industry standard 30 volts.

Maximum Ratings

Emitter

Peak Reverse Voltage.....6.0 V
 Continuous Forward Current.....60 mA
 Power Dissipation at 25°C90 mW
 Derate Linearly from 25°C1.2 mW/°C

Detector

Collector-Emitter Breakdown Voltage70 V
 Emitter-Collector Breakdown Voltage7 V
 Collector-Base Breakdown Voltage70 V
 Power Dissipation150 mW
 Derate Linearly from 25°C2.0 mW/°C

Package

Total Package Dissipation at 25°C Ambient
 (LED + Detector)240 mW
 Derate Linearly from 25°C3.3 mW/°C
 Storage Temperature-55°C to +150°C
 Operating Temperature-55°C to +100°C
 Soldering Time at 260°C.....10 sec.

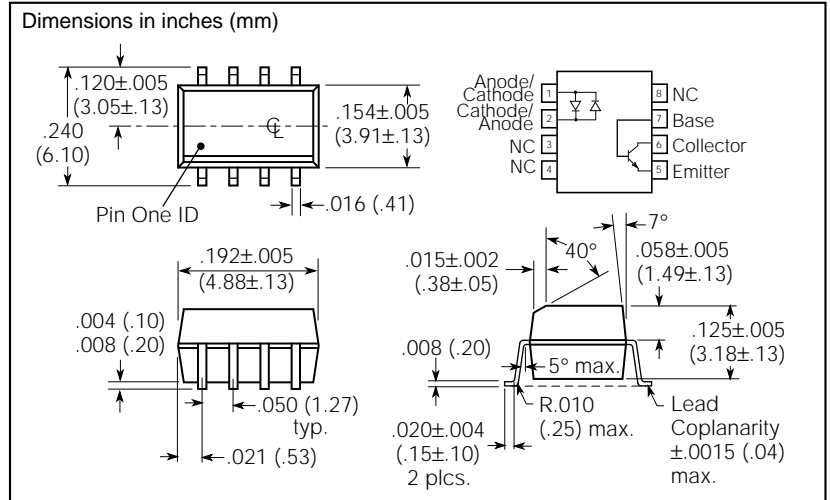

Characteristics ($T_A=25^\circ\text{C}$)

	Sym	Min.	Typ.	Max.	Unit	Condition
Emitter						
Forward Voltage	V_F		1.3	1.5	V	$I_F=\pm 10\text{ mA}$
Reverse Current	I_R		0.1	100	μA	$V_R=6.0\text{ V}$
Capacitance	C_O		25		pF	$V_R=0$
Detector						
Breakdown Voltage Collector-Emitter	BV_{CEO}	70			V	$I_C=100\text{ mA}$
Emitter-Collector	BV_{ECO}	7	10		V	$I_E=100\text{ }\mu\text{A}$
Leakage Current, Collector-Emitter	I_{CEO}		5	50	nA	$V_{CE}=10\text{ V}$
Package						
DC Current Transfer	CTR_{DC}				%	$I_F=\pm 10\text{ mA}$, $V_{CE}=5\text{ V}$
IL205A		40		80		
IL206A		63		125		
IL207A		100		200		
IL208A		100		320		
DC Current Transfer	CTR_{DC}				%	$I_F=\pm 1\text{ mA}$, $V_{CE}=5\text{ V}$
IL205A		13	25			
IL206A		22	40			
IL207A		34	60			
IL208A		56	95			
Saturation Voltage, Collector-Emitter	V_{CEsat}			0.4		$I_C=2.0\text{ mA}$, $I_F=10\text{ mA}$,
Isolation Test Voltage	V_{IO}	2500			VAC _{RMS}	
Equivalent DC Isolation Voltage		3535			VDC	
Capacitance, Input to Output	C_{IO}		0.5		pF	
Resistance, Input to Output	R_{IO}		100		G Ω	
Switching Time	t_{ON} , t_{OFF}		3.0		μs	$I_C=2.0\text{ mA}$, $R_E=100\text{ }\Omega$, $V_{CE}=10\text{ V}$

Figure 1. Forward voltage versus forward current

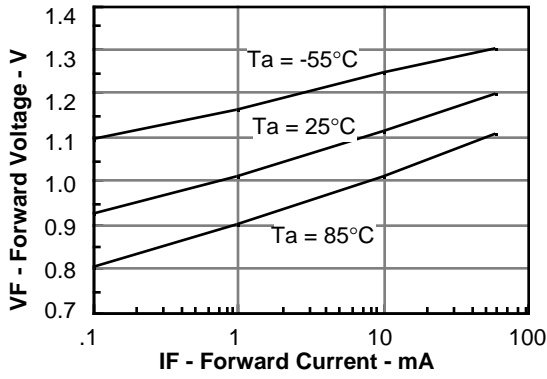

Figure 2. Normalized non-saturated and saturated CTR_{cce} versus LED current

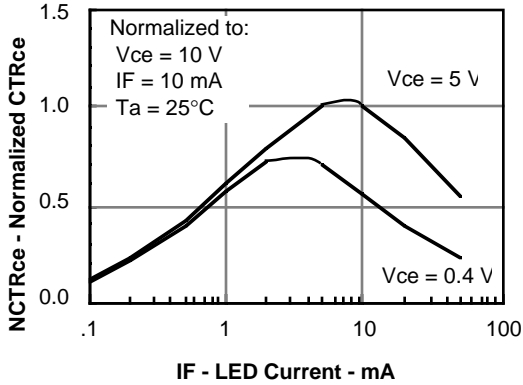

Figure 3. Collector-emitter current versus LED current

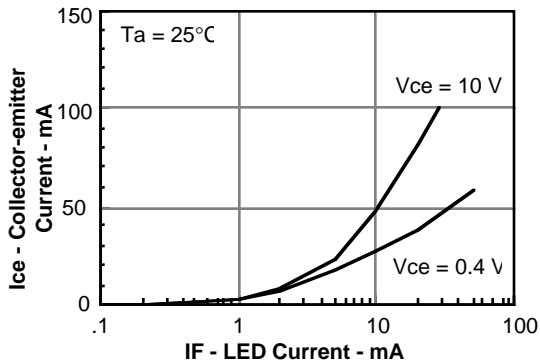

Figure 4. Normalized collector-base photocurrent versus LED current

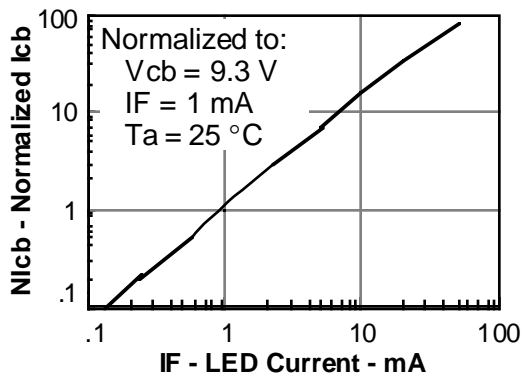

Figure 5. Normalized collector-base photocurrent versus LED current

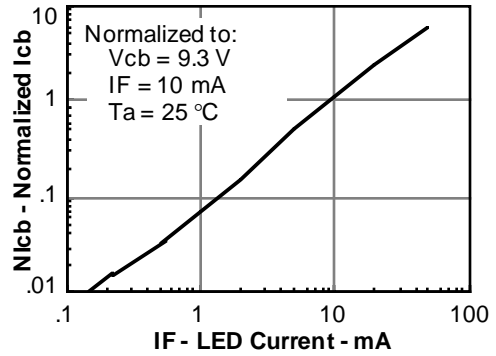

Figure 6. Collector-emitter photocurrent versus LED current

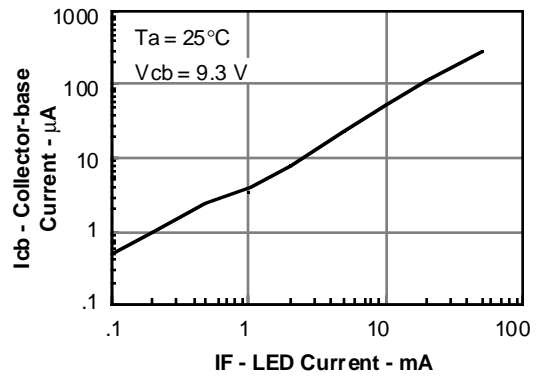

Figure 7. Collector-emitter photocurrent versus LED current

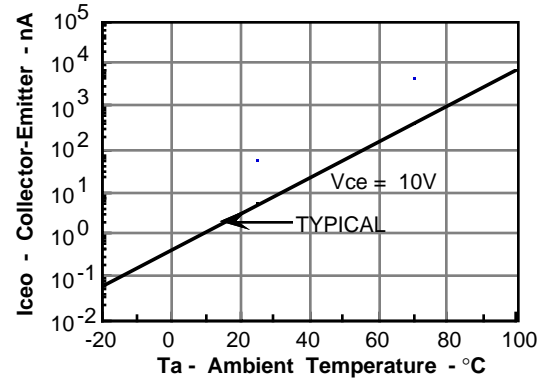

Figure 8. Base current versus If and HFE

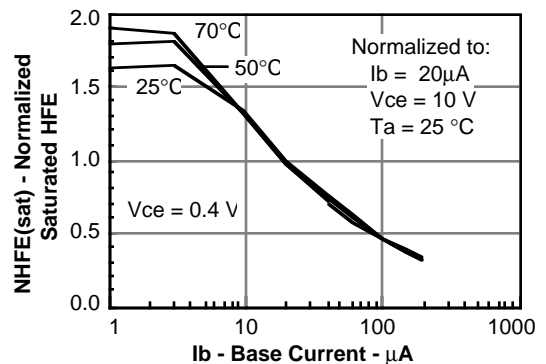

Figure 9. Typical switching characteristics versus base resistance (saturated operation)

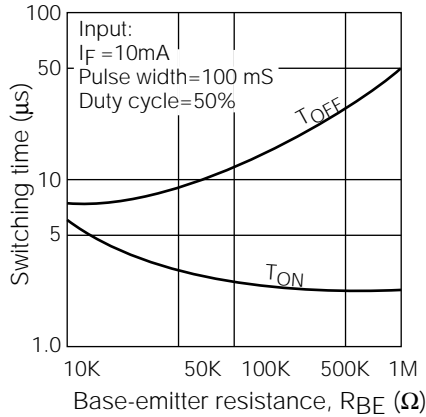

Figure 10. Typical switching times versus load resistance

