

SLOTTED OPTICAL SWITCHES PHOTOTRANSISTOR OUTPUT

KT830 - KT840 SERIES

F-41-73



Optek Technology, Inc
345 Industrial Blvd.
McKinney, Texas 75069
(214) 542-9461

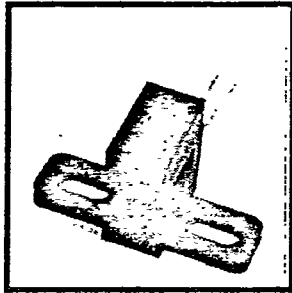

PACKAGE L

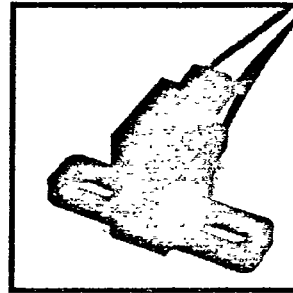

PACKAGE W

DESCRIPTION

The KT830/KT840 series of slotted optical switches provide the design engineer with the flexibility of a custom device from a standard product line. Building from a standard housing with a .125" wide slot, the user can specify (1) Electrical output parameters, (2) Lead or wire termination, (3) Lead spacing, (4) Discrete shell, and (5) Aperture widths.

All housings are an opaque grade of injection-molded polysulfone (P1700-935) to minimize the assembly's sensitivity to ambient radiation, both visible and near-infrared. Discrete shells (exposed only on the parallel faces inside the device throat) are either IR transmissive polysulfone (P1700-1615) for applications where aperture contamination may occur, or opaque polysulfone where maximum protection against ambient radiation is a concern.

The "L" series of switches have .020" square leads and can be specified for either .220" or .320" spacing.

The "W" series of switches are terminated with 24 inches of 7 strand, 26 AWG, UL 1429 insulated wire on each terminal. Insulation colors and functions are:

RED - IRED Anode
BLACK - IRED Cathode

WHITE - Phototransistor Collector
GREEN - Phototransistor Emitter

Other wire lengths and/or colors are available. Contact your local representative or call the factory.

JANUARY 1987

PART NUMBER GUIDE

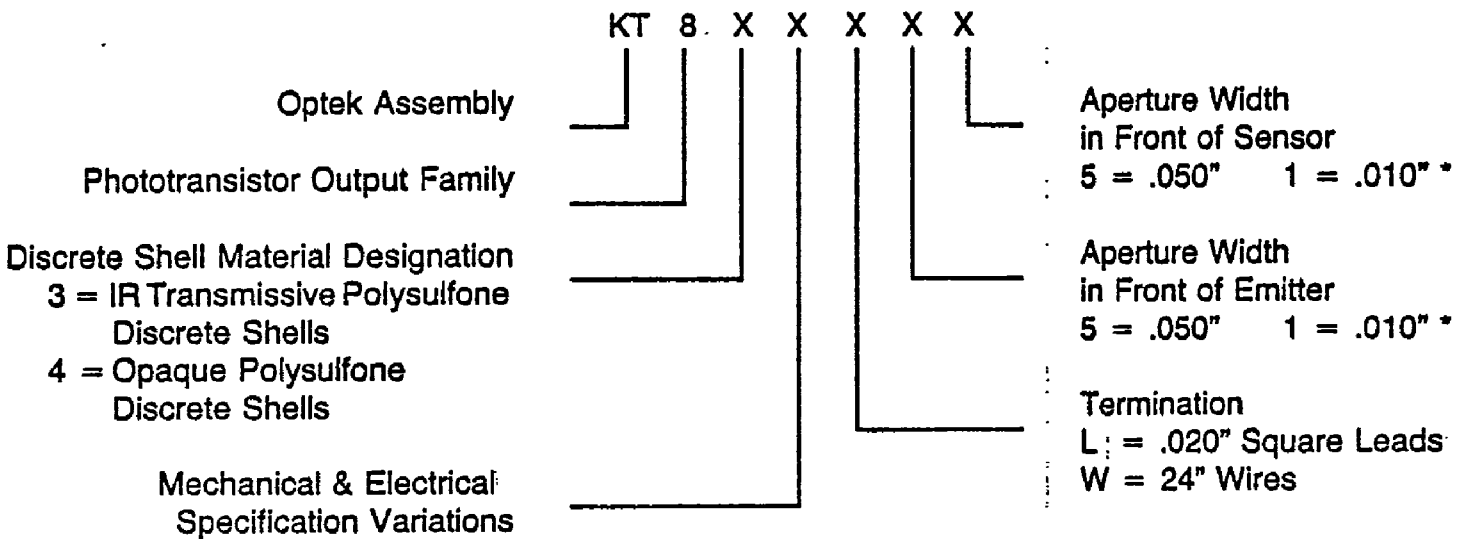

- 0 = Electrical Parameter A
Lead Spacing .320" **
- 1 = Electrical Parameter B
Lead Spacing .320" **
- 2 = Electrical Parameter C
Lead Spacing .320" **

- 5 = Electrical Parameter A
Lead Spacing .220" **
- 6 = Electrical Parameter B
Lead Spacing .220" **
- 7 = Electrical Parameter C
Lead Spacing .220" **

*Assemblies with dual .010" apertures are currently available with electrical parameter "A" only.
 **Refers to "L" configuration only.

EXAMPLE

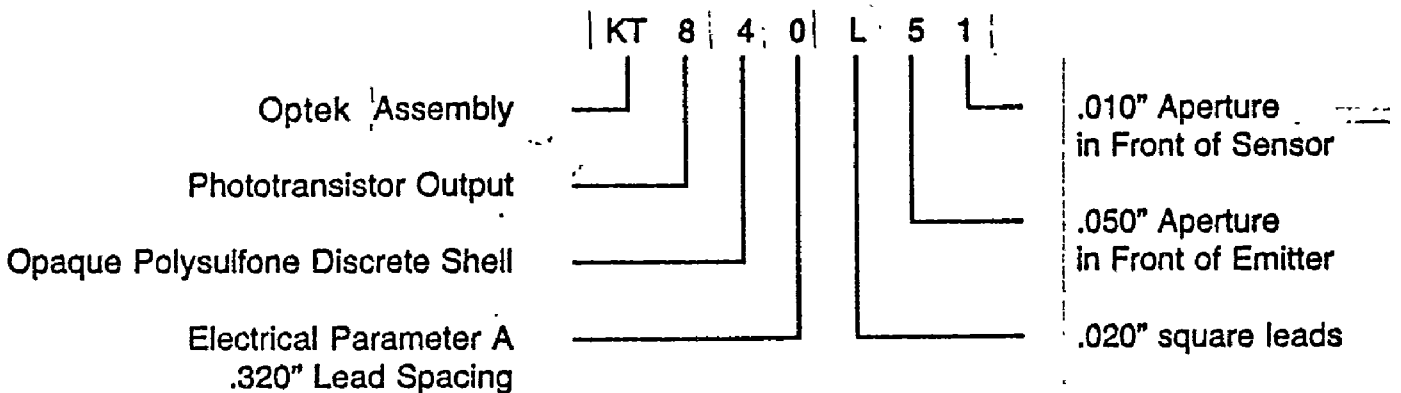

KT830-KT840 W SERIES

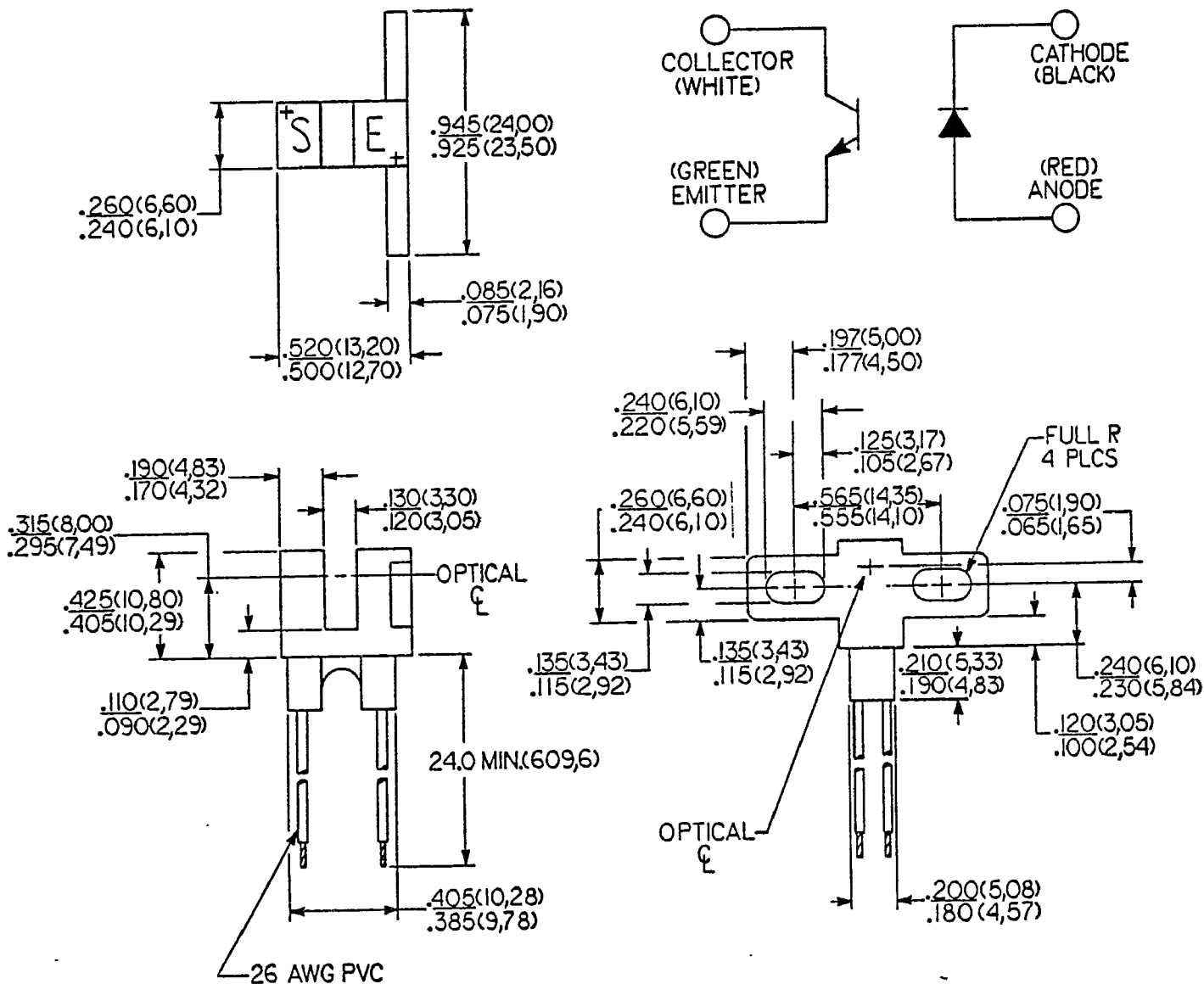

3

NOTE:

Housing is soluble in chlorinated hydrocarbons and ketones.
Methanol or isopropanol are recommended as a cleaning agent.

MECHANICAL CONSTRUCTION

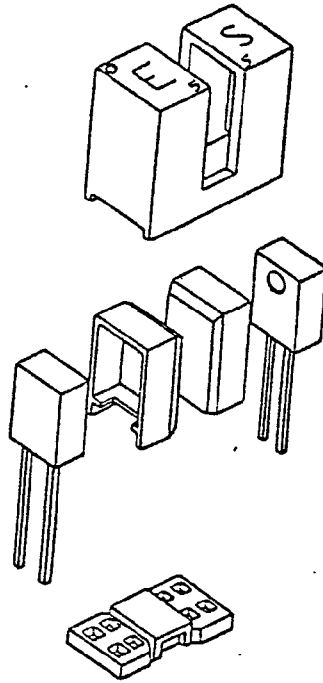

All housings are an opaque grade of injection-molded polysulfone (P1700-935) to minimize the assembly's sensitivity to ambient radiation, both visible and near-infrared. Discrete shells (exposed only on the parallel faces inside the device throat) are either IR transmissive polysulfone (P1700-1615) for applications where aperture contamination may occur, or opaque polysulfone (P1700-935) with aperture openings, where maximum protection against ambient radiation is a concern.

TYPES KT830 KT840 SERIES

ELECTRICAL CHARACTERISTICS (25°C UNLESS OTHERWISE NOTED)						
SYMBOL	PARAMETER	MIN	MAX	UNITS	TEST CONDITIONS	
INPUT DIODE						
V _F	FORWARD VOLTAGE		1.7	V	I _F = 20 mA	
I _R	REVERSE CURRENT		100	µA	V _R = 3V	
OUTPUT PHOTOTRANSISTOR						
V _{(BR)CEO}	COLLECTOR-EMITTER BREAKDOWN VOLTAGE	30		V	I _C = 1 mA	
V _{(BR)ECO}	EMITTER-COLLECTOR BREAKDOWN VOLTAGE	5		V	I _E = 100 µA	
I _{CEO}	COLLECTOR-EMITTER DARK CURRENT		100	nA	V _{CE} = 10V	
COUPLED						
V _{CE (SAT)}	COLLECTOR-EMITTER SATURATION VOLTAGE Parameter A - KT830, KT840 KT835, KT845		0.4	V	I _C = 400µA, I _F = 20 mA	
	Parameter B - KT831, KT841 KT836, KT846		0.4	V	I _C = 800µA, I _F = 10 mA	
	Parameter C - KT832, KT842 KT837, KT847		0.6	V	I _C = 1800µA, I _F = 20 mA	
I _{C (ON)}	ON-STATE COLLECTOR CURRENT Parameter A - KT830, KT840 KT835, KT845	500		µA	V _{CE} = 10V, I _F = 20 mA	
	Parameter B - KT831, KT841 KT836, KT846	1000		µA	V _{CE} = 5V, I _F = 10 mA	
	Parameter C - KT832, KT842 KT837, KT847	1800		µA	V _{CE} = 0.6V, I _F = 20 mA	

ABSOLUTE MAXIMUM RATINGS (25° C unless otherwise noted)

Storage and Operating Temperature Range KT830L /KT840L Series -40°C to +85°C (A)
 KT830W/KT840W Series -40°C to +80°C (B)

Lead Soldering Temperature (1/16" from case
 for 5 seconds with soldering iron) + 240°C (C)

INPUT DIODE

Forward DC Current 50 mA
 Peak Forward Current (1 us pulse width, 300pps) 3 A
 Reverse DC Voltage 3 V
 Power Dissipation 100 mW (A)
 Power Dissipation 100 mW (B)

OUTPUT PHOTOTRANSISTOR

Collector-Emitter Voltage 30 V
 Emitter-Collector Voltage 5 V
 Collector DC Current 30 mA
 Power Dissipation 100 mW (A)
 Power Dissipation 100 mW (B)

- Notes:
- (A) Derate linearly 1.67mW/°C above 25°C (KT830L/KT840L)
 - (B) Derate linearly 1.82mW/°C above 25°C (Maximum storage and operating temperature limited by temperature rating of lead wires (KT830W/KT840W))
 - (C) Applies to KT830L/KT840L Series only. RMA flux is recommended. Duration can be extended to 10 seconds maximum when wave soldering.
 - (D) All parameters tested using pulse technique.

KT830-KT840 L SERIES

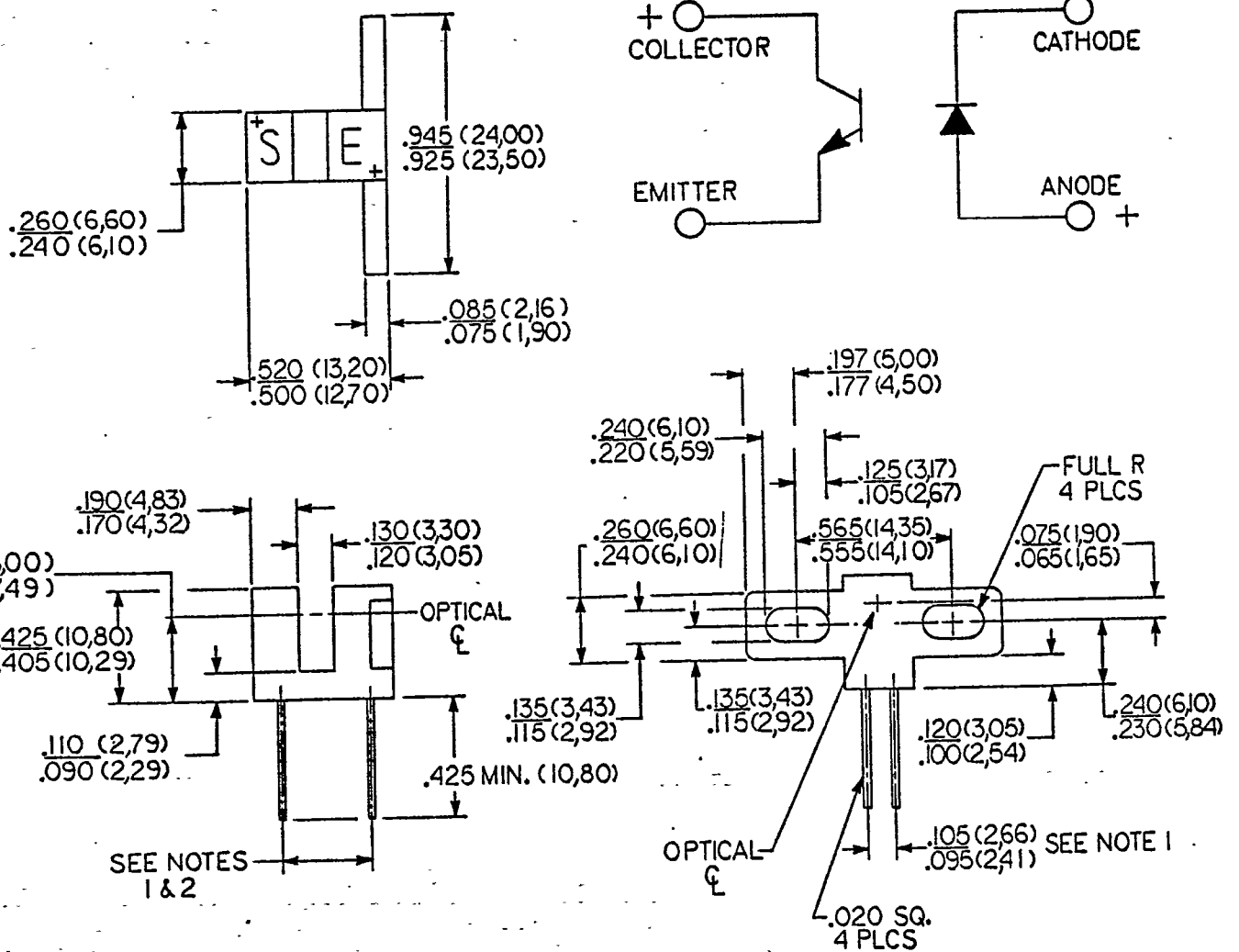

NOTES:

1. Dimension controlled at housing surface only.
2. KT830L thru KT832L and KT840L thru KT842L lead spacing: $.320'' \pm .005''$.
KT835L thru KT837L and KT845L thru KT847L lead spacing: $.220'' \pm .005''$
3. Housing is soluble in chlorinated hydrocarbons and ketones.
Methanol or isopropanol are recommended as a cleaning agent.

TYPICAL PERFORMANCE CURVES

OPTEK TECHNOLOGY reserves the right to make changes at anytime without prior notice.

Normalized Output Current vs Forward Current

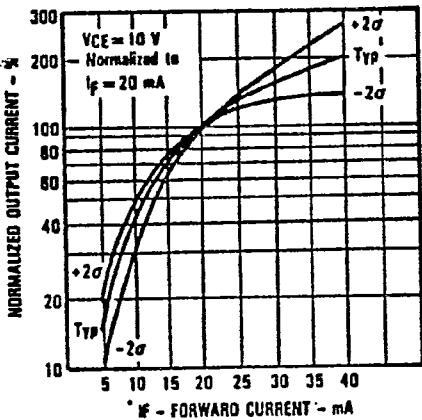

Normalized Output Current vs. Ambient Temperature

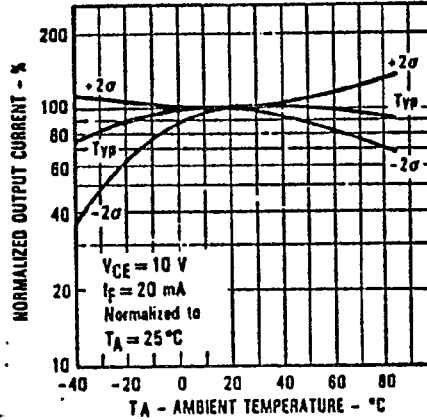

Forward Current vs Forward Voltage

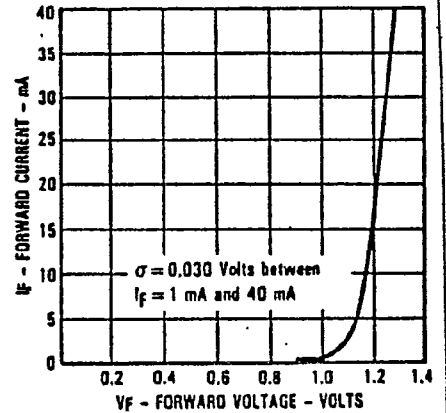

Relative Output Current vs Time

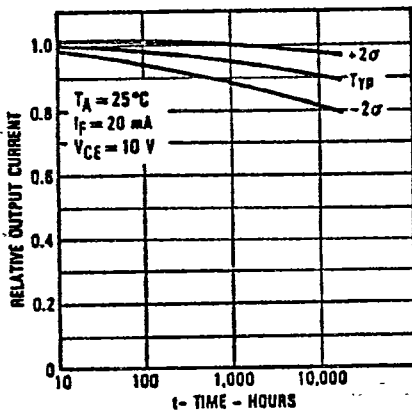

Collector Dark Current vs Ambient Temperature

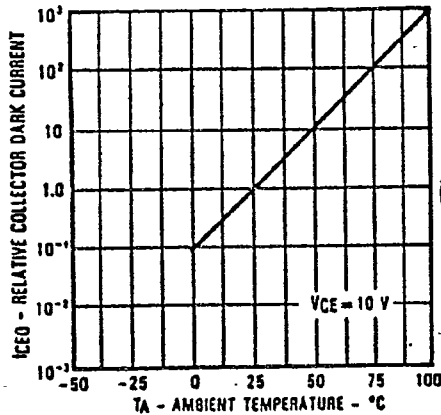

Rise and Fall Time vs Load Resistance

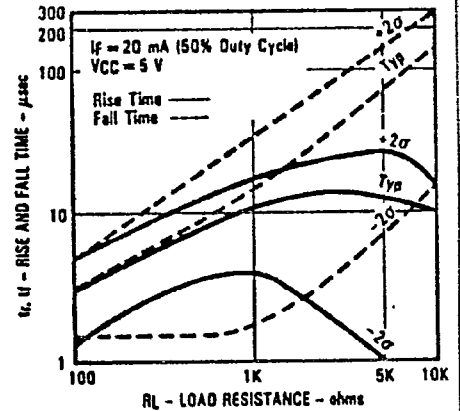

Reduction in Output Current Due to LED Heating vs Forward Current

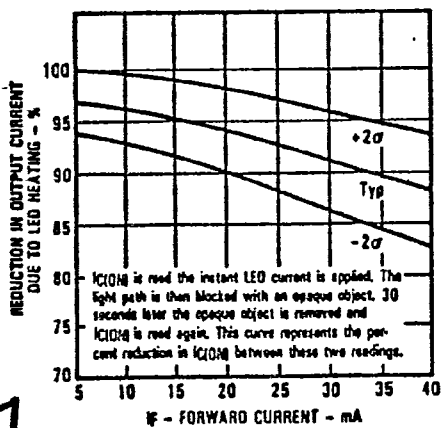

Normalized Output Current vs Input Current

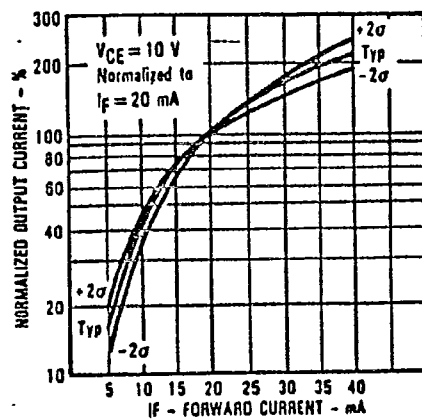

Rise and Fall Time vs Load Resistance

