

Description

The μPD4016 is a 16,384-bit static Random-access Memory device organized as 2,048 words by 8 bits. Using a scaled NMOS technology, its design provides the ease-of-use features associated with nonclocked static memories. The μPD4016 has a three-state output and offers a standby mode with an attendant 75% savings in power consumption. It features equal access and cycle times and provides an output enable function that eliminates the need for external bus buffers. The μPD4016 is packaged in a 600-mil-wide standard 24-pin dual-in-line package which is plug-compatible with 16K EPROMS.

Features

- Scaled NMOS technology
- Completely static memory: no clock, no refresh
- Equal access and cycle times
- Single +5V power supply
- Automatic power-down
- All inputs and outputs directly TTL-compatible
- Common I/O capability
- OE eliminates need for external bus buffers
- Three-state outputs
- Plug-compatible with 16K 5V EPROMS (600 mil)
- Low power dissipation in standby mode
- Available in a standard 24-pin dual-in-line package (600-mil width)
- 4 performance ranges:

Device	Access Time	R/W Cycle Time	Power Supply	
			Active	Standby
μPD4016C-1	250ns	250ns	60mA	15mA
μPD4016C-2	200ns	200ns	60mA	15mA
μPD4016C-3	150ns	150ns	60mA	15mA
μPD4016C-5	120ns	120ns	60mA	15mA

Pin Configuration

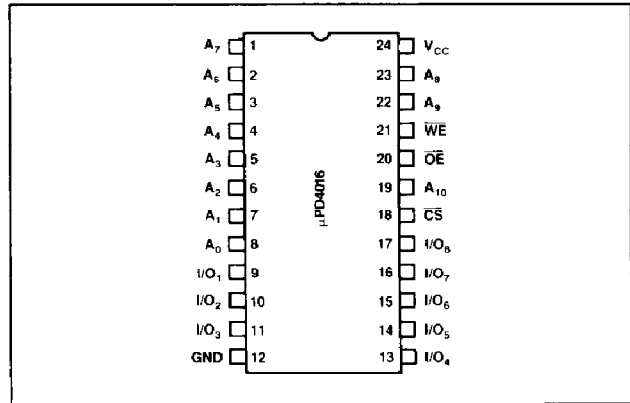

Pin Identification

No.	Pin Symbol	Description
1-8, 22, 23	A ₀ -A ₁₀	Address Inputs
9-11, 13-17	I/O ₁ -I/O ₈	Data Input/Output
12	GND	Ground
18	CS	Chip Select
20	OE	Output Enable
21	WE	Write Enable
24	V _{CC}	+5V Power Supply

Truth Table

CS	OE	WE	Mode	I/O	Power
H	X	X	Not Selected	High-Z	Standby
L	L	H	Read	D _{OUT}	Active
L	H	L	Write	D _{IN}	Active
L	L	L	Write	D _{IN}	Active

Absolute Maximum Ratings*

Temperature Under Bias	-10°C to +85°C
Storage Temperature, T _{ST}	-55°C to +125°C
Voltage on any Pin with Respect to Ground	-1.5V to +7V
DC Output Current, I _O	20mA
Power Dissipation, P _D	1W

* COMMENT: Exposing the device to stresses above those listed in Absolute Maximum Ratings could cause permanent damage. The device is not meant to be operated under conditions outside the limits described in the operational sections of this specification. Exposure to absolute maximum rating conditions for extended periods may affect device reliability.

Block Diagram

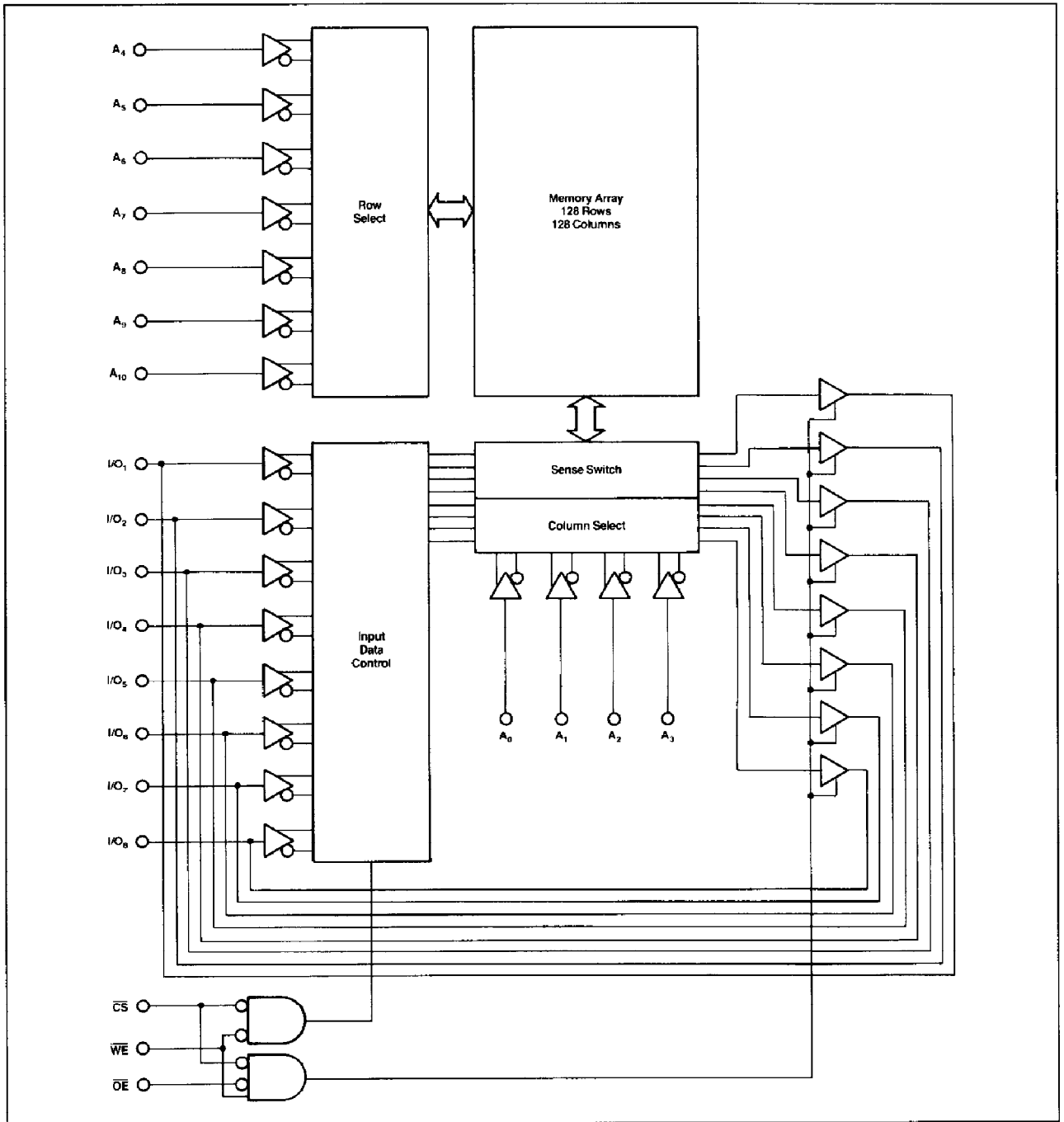

Capacitance ①

$T_A = 25^\circ\text{C}; f = 1\text{MHz}$

Parameter	Symbol	Limits			Unit	Test Conditions
		Min	Typ	Max		
Input Capacitance	C_{IN}			5	pF	$V_{IN} = 0\text{V}$
I/O Capacitance	C_{IO}			7	pF	$V_{IO} = 0\text{V}$

Note: ① This parameter is sampled and not 100% tested.

DC Characteristics

$T_A = 0^\circ\text{C to } +70^\circ\text{C}; V_{CC} = 5\text{V} \pm 10\%$

Parameter	Symbol	Limits			Unit	Test Conditions ①
		Min	Typ	Max		
Input Leakage Current	I_{LI}			10	μA	$V_{CC} = \text{Max}$ $V_{IN} = \text{GND to } V_{CC}$
Output Leakage Current	I_{LO}			10	μA	$V_{CC} = \text{Max}; \overline{\text{CS}} = V_{IH}$ $V_{OUT} = \text{GND to } V_{CC}$
Operating Current	I_{CC}			60	mA	$V_{CC} = \text{Max}; \overline{\text{CS}} = V_{IL}$ (outputs open)
Standby Current	I_{SB}			15	mA	$V_{CC} = \text{Min to Max};$ $\overline{\text{CS}} = V_{IH}$
Input Low Voltage	V_{IL}	-1.5		0.8	V	
Input High Voltage	V_{IH}	2.0		6.0	V	
Output Low Voltage	V_{OL}			0.4	V	$I_{OL} = 4\text{mA}$
Output High Voltage	V_{OH}	2.4			V	$I_{OH} = 1\text{mA}$
Output Short-circuit Current	I_{OS}		70		mA	$V_{OUT} = \text{GND to } V_{CC}$

Note: ① Input pulse levels: 0.8V to 2.2V
Input rise and fall times: 10ns
Input timing reference levels: 1.5V
Output timing reference levels: 1.5V

Figure 1. Loading Conditions Test Circuit

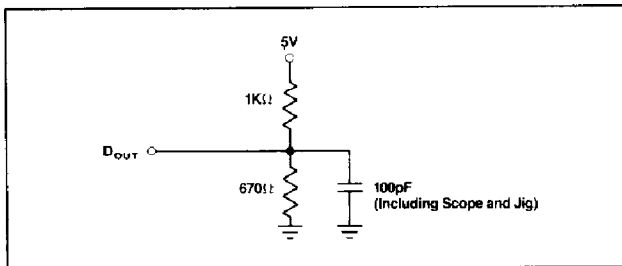
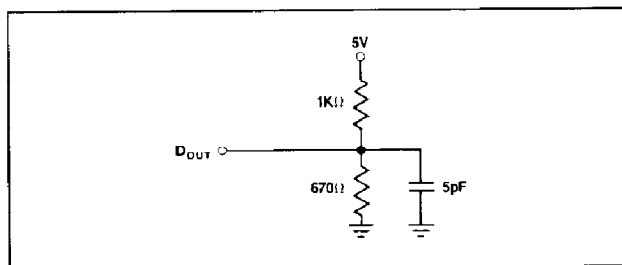

Figure 2. Input Pulse Test Circuit



AC Characteristics

$T_A = 0^\circ\text{C to } +70^\circ\text{C}; V_{CC} = 5\text{V} \pm 10\%$

Read Cycle

Parameter	Symbol	Limits ①								Unit	Notes
		4016-5		4016-3		4016-2		4016-1			
		Min	Max	Min	Max	Min	Max	Min	Max		
Read Cycle Time	t_{RC}	120		150		200		250		ns	②
Address Access Time	t_{AA}		120		150		200		250	ns	
Chip Select Access Time	t_{ACS}		120		150		200		250	ns	③
Output Hold from Address Change	t_{OH}	10		10		10		10		ns	
Chip Selection to Output in Low-Z	t_{LZ}	10		10		10		10		ns	④ ⑤
Chip Deselection to Output in High-Z	t_{HZ}		45		50		60		80	ns	④ ⑤
Output Enable to Output Valid	t_{OE}		50		70		90		110	ns	
Output Enable to Output in Low-Z	t_{OLZ}	10		10		10		10		ns	④ ⑤
Output Disable to Output in High-Z	t_{OHZ}		45		50		60		80	ns	④ ⑤
Chip Selection to Power-up Time	t_{PU}	0		0		0		0		ns	⑤
Chip Deselection to Power-down Time	t_{PD}		60		70		90		110	ns	⑤

Write Cycle

Parameter	Symbol	Limits ①								Unit	Notes
		4016-5		4016-3		4016-2		4016-1			
		Min	Max	Min	Max	Min	Max	Min	Max		
Write Cycle Time	t_{WC}	120		150		200		250		ns	
Chip Selection to End of Write	t_{CW}	90		120		160		200		ns	
Address Valid to End of Write	t_{AW}	80		90		120		150		ns	
Address Set-up Time	t_{AS}	0		0		0		0		ns	
Write Pulse Width	t_{WP}	70		80		100		130		ns	⑥
Write Recovery Time	t_{WR}	10		10		10		10		ns	
Data Valid to End of Write	t_{DW}	45		50		60		80		ns	
Data Hold Time	t_{DH}	0		0		0		0		ns	
Write Enabled to Output in High-Z	t_{WZ}		45		50		60		80	ns	⑤ ⑦
Output Active from End of Write	t_{OW}	10		10		10		10		ns	⑤ ⑦

Notes: ① See Part No. Package Width table below.
② All read cycle timings are referenced from the last valid address to the first transition address.
③ Address valid prior to or coincident with $\overline{\text{CS}}$ transition low.
④ Transition is measured -200mV from steady-state voltage with specified load of Figure 1.
⑤ This parameter is sampled and not 100% tested.
⑥ If $\overline{\text{CS}}$ and $\overline{\text{OE}}$ are both low before write enabled, $t_{WP} = t_{WZ} + t_{OW}$.
⑦ Transition is measured $+200\text{mV}$ from steady-state voltage with specified load of Figure 2.

7

Timing Waveforms

Write Cycle No. 1 (\overline{WE} Controlled)

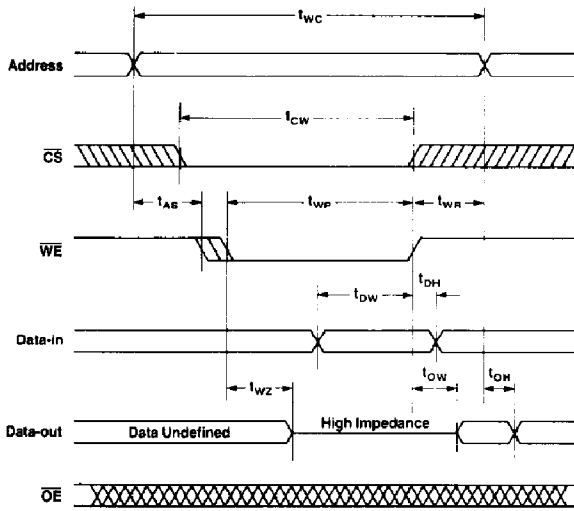

Write Cycle No. 2 (\overline{CS} Controlled)

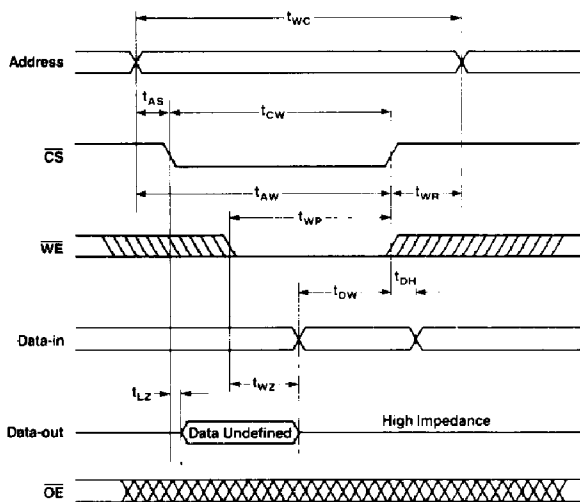

Read Cycle No. 1 ① ② ③

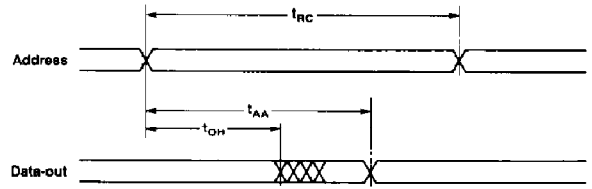

Read Cycle No. 2 ① ③ ④

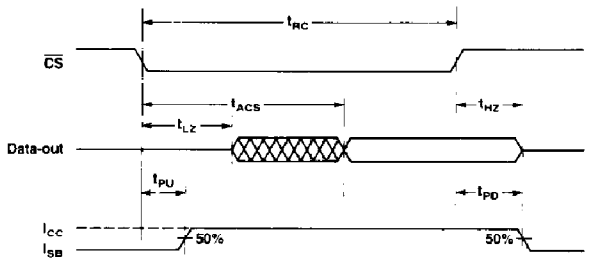

Read Cycle No. 3 ① ②

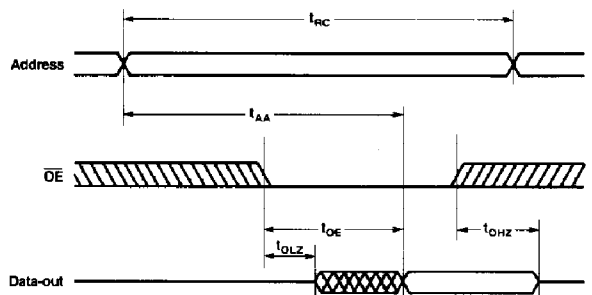

- Notes:
- ① \overline{WE} is high for read cycles.
 - ② Device is continuously selected, $\overline{CS} = V_{IL}$.
 - ③ $\overline{OE} = V_{IL}$.
 - ④ Address valid prior to or coincident with \overline{CS} transition low.