

HD74HC123A

Dual Retriggerable Monostable Multivibrators (with Clear)

HITACHI

ADE-205-438 (Z)
1st. Edition
Sep. 2000

Description

This multivibrator features both a negative, A, and a positive, B, transition triggered input, either of which can be used as an inhibit input. Also included is a clear input that when taken low resets the one shot. The HD74HC123A can be triggered on the positive transition of the clear while A is held low and B is held high.









The HD74HC123A is retriggerable. That is it may be triggered repeatedly while their outputs are generating a pulse and the pulse will be extended.

Pulse width stability over a wide range of temperature. The output pulse equation is simply: $t_w = (R_{ext}) (C_{ext})$.

Features

- High Speed Operation
- High Output Current: Fanout of 10 LSTTL Loads
- Wide Operating Voltage: $V_{CC} = 2$ to 6 V
- Low Input Current: 1 μ A max
- Low Quiescent Supply Current

Function Table

Inputs			Outputs	
Clear	A	B	Q	\bar{Q}
L	X	X	L	H
X	H	X	L	H
X	X	L	L	H
H	L			
H		H		
	L	H		

Note: External timing capacitance connects between C_{ext} and R_{ext}/C_{ext} .

HD74HC123A

Pin Arrangement

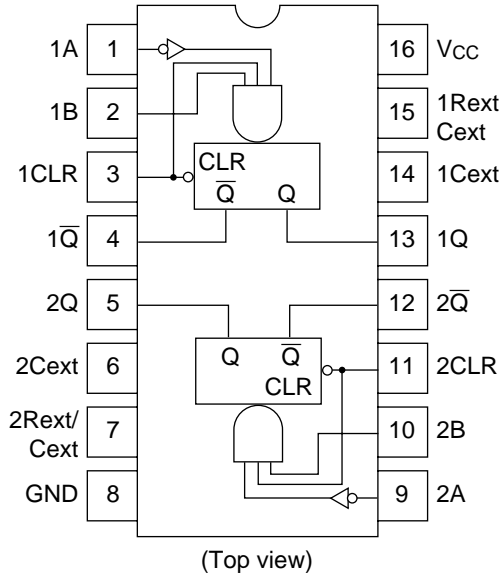

DC Characteristics

Item	Sym- bol	V _{CC} (V)	Ta = 25°C		Ta = -40 to +85°C		Unit	Test Conditions		
			Min	Typ	Max	Min			Max	
Input voltage	V _{IH}	2.0	1.5	—	—	1.5	—	V		
		4.5	3.15	—	—	3.15	—			
		6.0	4.2	—	—	4.2	—			
	V _{IL}	2.0	—	—	0.5	—	0.5		V	
		4.5	—	—	1.35	—	1.35			
		6.0	—	—	1.8	—	1.8			
Output voltage	V _{OH}	2.0	1.9	2.0	—	1.9	—	V		Vin = V _{IH} or V _{IL} I _{OH} = -20 μA
		4.5	4.4	4.5	—	4.4	—			
		6.0	5.9	6.0	—	5.9	—			
		4.5	4.18	—	—	4.13	—		I _{OH} = -4 mA	
		6.0	5.68	—	—	5.63	—		I _{OH} = -5.2 mA	
	V _{OL}	2.0	—	0.0	0.1	—	0.1	V	Vin = V _{IH} or V _{IL} I _{OL} = 20 μA	
		4.5	—	0.0	0.1	—	0.1			
		6.0	—	0.0	0.1	—	0.1			
		4.5	—	—	0.26	—	0.33			I _{OL} = 4 mA
		6.0	—	—	0.26	—	0.33			I _{OL} = 5.2 mA
Input current	lin	6.0	—	—	±0.1	—	±1.0	μA	Vin = V _{CC} or GND	
Quiescent	Standby state	I _{CC}	6.0	—	—	130	—	220	μA	Vin = V _{CC} or I _{out} = 0 μA
supply current	Active state			—	—	130	—	220		GND Rext/Cext = 0.5 V _{CC}

HD74HC123A

AC Characteristics ($C_L = 50$ pF, Input $t_r = t_f = 6$ ns)

Item	Symbol	V_{CC} (V)	$T_a = 25^\circ\text{C}$		$T_a = -40$ to $+85^\circ\text{C}$		Unit	Test Conditions				
			Min	Typ	Max	Min			Max			
Propagation delay time	t_{PLH}	2.0	—	—	210	—	265	ns	A, B or Clear to Q			
		4.5	—	22	42	—	53					
		6.0	—	—	36	—	45					
	t_{PHL}	2.0	—	—	240	—	300	ns	A, B or Clear to \bar{Q}			
		4.5	—	23	48	—	60					
		6.0	—	—	41	—	51					
	t_{PHL}	2.0	—	—	170	—	215	ns	Clear to Q			
		4.5	—	18	34	—	43					
		6.0	—	—	29	—	37					
	t_{PLH}	2.0	—	—	180	—	225	ns	Clear to \bar{Q}			
		4.5	—	16	36	—	45					
		6.0	—	—	31	—	38					
Output rise time	t_{TLH}	2.0	—	—	75	—	95	ns				
		4.5	—	5	15	—	19					
		6.0	—	—	13	—	16					
Output fall time	t_{THL}	2.0	—	—	75	—	95	ns				
		4.5	—	5	15	—	19					
		6.0	—	—	13	—	16					
Pulse width	t_w	2.0	150	—	—	190	—	ns	A, B, Clear			
		4.5	30	6	—	38	—					
		6.0	26	—	—	33	—					
Minimum output pulse width	$t_{WQ(\min)}$	2.0	—	1.5	—	—	—	μs	Cext = 28 pF	Rext = 6 k Ω		
		4.5	—	450	—	—	—				ns	Rext = 2 k Ω
		6.0	—	380	—	—	—					
Output pulse width	t_{WQ}	4.5	—	1.0	—	—	—	ms	Cext = 0.1 μF , Rext = 10 k Ω			
Input capacitance	C_{in}	—	—	5	10	—	10	pF				

Caution in use: In order to prevent any malfunctions due to noise, connect a high-frequency performance capacitor between V_{CC} and GND, and keep the wiring between the External components and Cext, Rext/Cext pins as short as possible.

Package Dimensions

Unit: mm

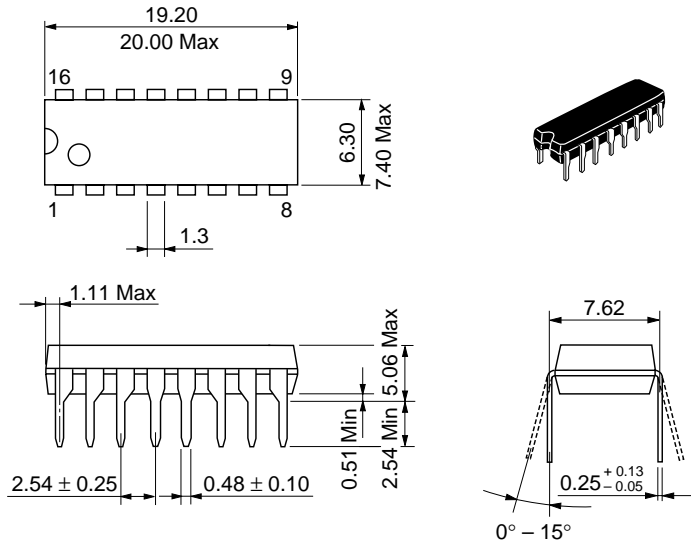

Hitachi Code	DP-16
JEDEC	Conforms
EIAJ	Conforms
Mass (reference value)	1.07 g

Unit: mm

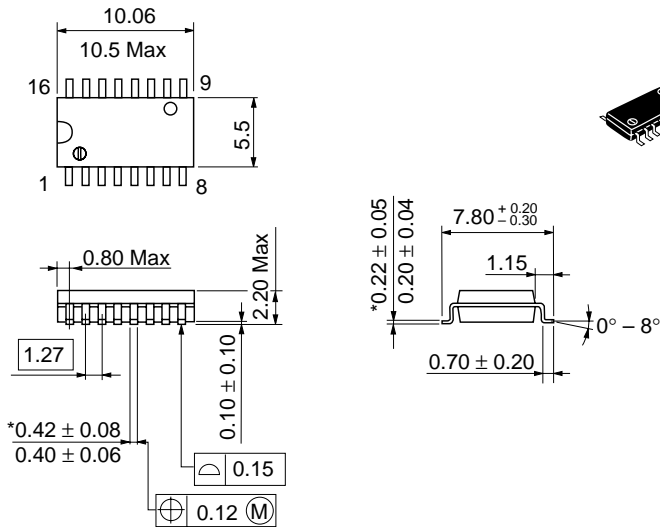

Hitachi Code	FP-16DA
JEDEC	—
EIAJ	Conforms
Mass (reference value)	0.24 g

*Dimension including the plating thickness
Base material dimension

Cautions

1. Hitachi neither warrants nor grants licenses of any rights of Hitachi's or any third party's patent, copyright, trademark, or other intellectual property rights for information contained in this document. Hitachi bears no responsibility for problems that may arise with third party's rights, including intellectual property rights, in connection with use of the information contained in this document.
2. Products and product specifications may be subject to change without notice. Confirm that you have received the latest product standards or specifications before final design, purchase or use.
3. Hitachi makes every attempt to ensure that its products are of high quality and reliability. However, contact Hitachi's sales office before using the product in an application that demands especially high quality and reliability or where its failure or malfunction may directly threaten human life or cause risk of bodily injury, such as aerospace, aeronautics, nuclear power, combustion control, transportation, traffic, safety equipment or medical equipment for life support.
4. Design your application so that the product is used within the ranges guaranteed by Hitachi particularly for maximum rating, operating supply voltage range, heat radiation characteristics, installation conditions and other characteristics. Hitachi bears no responsibility for failure or damage when used beyond the guaranteed ranges. Even within the guaranteed ranges, consider normally foreseeable failure rates or failure modes in semiconductor devices and employ systemic measures such as fail-safes, so that the equipment incorporating Hitachi product does not cause bodily injury, fire or other consequential damage due to operation of the Hitachi product.
5. This product is not designed to be radiation resistant.
6. No one is permitted to reproduce or duplicate, in any form, the whole or part of this document without written approval from Hitachi.
7. Contact Hitachi's sales office for any questions regarding this document or Hitachi semiconductor products.

HITACHI

Hitachi, Ltd.

Semiconductor & Integrated Circuits.
Nippon Bldg., 2-6-2, Ohte-machi, Chiyoda-ku, Tokyo 100-0004, Japan
Tel: Tokyo (03) 3270-2111 Fax: (03) 3270-5109

URL NorthAmerica : <http://semiconductor.hitachi.com/>
 Europe : <http://www.hitachi-eu.com/hel/ecg>
 Asia : <http://sicapac.hitachi-asia.com>
 Japan : <http://www.hitachi.co.jp/Sicd/indx.htm>

For further information write to:

Hitachi Semiconductor
(America) Inc.
179 East Tasman Drive,
San Jose, CA 95134
Tel: <1> (408) 433-1990
Fax: <1> (408) 433-0223

Hitachi Europe GmbH
Electronic Components Group
Dornacher StraÙe 3
D-85622 Feldkirchen, Munich
Germany
Tel: <49> (89) 9 9180-0
Fax: <49> (89) 9 29 30 00

Hitachi Europe Ltd.
Electronic Components Group.
Whitebrook Park
Lower Cookham Road
Maidenhead
Berkshire SL6 8YA, United Kingdom
Tel: <44> (1628) 585000
Fax: <44> (1628) 585160

Hitachi Asia Ltd.
Hitachi Tower
16 Collyer Quay #20-00,
Singapore 049318
Tel: <65>-538-6533/538-8577
Fax : <65>-538-6933/538-3877
URL : <http://www.hitachi.com.sg>

Hitachi Asia Ltd.
(Taipei Branch Office)
4/F, No. 167, Tun Hwa North Road,
Hung-Kuo Building,
Taipei (105), Taiwan
Tel: <886>-(2)-2718-3666
Fax : <886>-(2)-2718-8180
Telex : 23222 HAS-TP
URL : <http://www.hitachi.com.tw>

Hitachi Asia (Hong Kong) Ltd.
Group III (Electronic Components)
7/F., North Tower,
World Finance Centre,
Harbour City, Canton Road
Tsim Sha Tsui, Kowloon,
Hong Kong
Tel : <852>-(2)-735-9218
Fax : <852>-(2)-730-0281
URL : <http://www.hitachi.com.hk>

Copyright © Hitachi, Ltd., 2000. All rights reserved. Printed in Japan.
Colophon 2.0

HITACHI