

FEATURES

- Normally Open, Single Pole Single Throw Operation
- Control 350 VAC or DC Voltage
- Switch 100 mA Loads
- LED Control Current, 1.5 mA
- Low ON-Resistance
- dv/dt , >500 V/ms
- Isolation Test Voltage, 3750 VAC_{RMS}
- Current Limiting
- Underwriters Lab File # E52744

APPLICATIONS

- Telephone Switch Hook
- High Voltage Test Equipment
- TRIAC Driver
- Motor Control
- Industrial Control Systems

DESCRIPTION

The LH1056 is a single pole single throw (SPST), normally open (NO), solid state relay. The relay can control AC or DC loads currents up to 100 mA, with a supply voltage up to 350 V. The device is packaged in a six pin 0.3 inch dual-in line package. This package offers an insulation dielectric withstand of 7500 VAC_{PK}.

The coupler consists of a AlGaAs LED that is optically coupled to a dielectrically isolated photodiode array which drives two series connected high voltage MOS transistors. The typical ON-Resistance is 30 Ω at 25 mA and is linear up to 50 mA. The incremental resistance drops to less than 20 Ω beyond 50 mA while reducing internal power dissipation at high load currents. There is built-in current limiting circuitry in the detector chip.

Package Dimensions in Inches (mm)

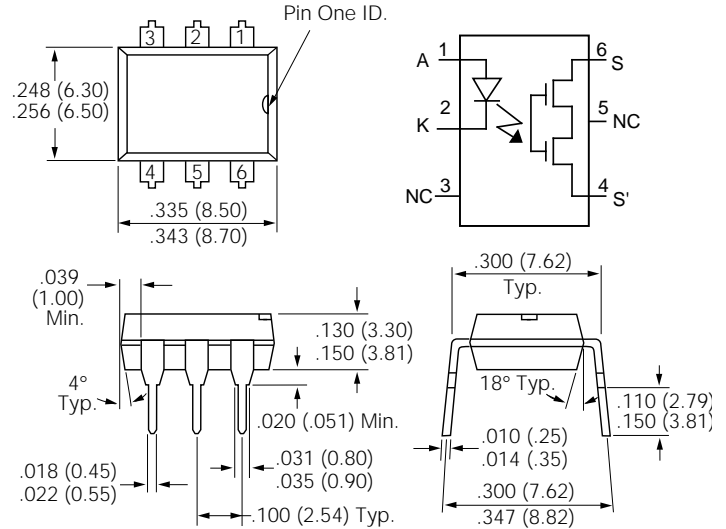

Absolute Maximum Ratings ($T_A=25^\circ\text{C}$)

Emitter

Reverse Voltage.....	6.0 V
Continuous Forward Current.....	60 mA
Peak Forward Current (1 μs).....	1 A
Power Dissipation.....	100 mW
Derate Linearly from 25°C.....	1.3 mW/°C

Detector

Output Breakdown Voltage.....	± 350 V
Continuous Load Current.....	± 100 mA
Total Power Dissipation.....	500 mW
Derate Linearly from 25°C.....	See Figure 7

Package

Isolation Test Voltage.....	3750 VAC _{RMS}
Isolation Resistance	
$V_{IO}=500$ V, $T_A=25^\circ\text{C}$	$\geq 10^{12}$ Ω
$V_{IO}=500$ V, $T_A=100^\circ\text{C}$	$\geq 10^{11}$ Ω
Power Dissipation.....	500 mW
Derate Linearly from 25°C.....	2.5 mW/°C
Storage Temperature Range.....	-40 to +150°C
Operating Temperature Range.....	-40 to +85°C
Junction Temperature.....	100°C
Soldering Temperature, 2 mm from case, 10 sec.....	260°C

Characteristics ($T_A=25^\circ\text{C}$)

Description	Symbol	Min.	Typ.	Max.	Unit	Test Condition
Emitter						
Forward Voltage	V_F		1.25	1.5	V	$I_F=10\text{ mA}$
V_F Temperature Coefficient	$\Delta V_F/\Delta T$		-2.2		mV/°C	
Reverse Current	I_R		1	10	μA	$V_R=6\text{ V}$
Junction Capacitance	C_J		15		pF	$V_F=0\text{ V}$, $f=1\text{ MHz}$
Dynamic Resistance	$\Delta V_F/\Delta I_F$		6		Ω	$I_F=10\text{ mA}$
Switching Time	t_R , t_F		1		μs	$I_F=10\text{ mA}$
Detector						
Output Breakdown Voltage	V_B	350	380		V	$I_B=50\text{ }\mu\text{A}$
Output Off-State Leakage Current	$I_{T(\text{OFF})}$.03	200	nA	$V_T=100\text{ V}$, $I_F=0\text{ mA}$
Feed through Capacitance, pins 4 to 6	C_T		24		pF	$I_F=0$, $f=1\text{ KHz}$, $V_L=4\text{ VP-P}$
Current Limit	I_{LMT}	100	150	210	mA	$I_F=5\text{ mA}$, $V_L=\pm 7\text{ V}$, $t=10\text{ ms}$
Package						
LED Forward Current for Turn-on	I_{FON}		2.5	3.5	mA	$V_L=\pm 7\text{ V}$, $I_L=100\text{ mA}$, $t=10\text{ ms}$
LED Forward Current for Turn-off	I_{FOFF}	0.2		1.3	mA	$V_L=\pm 300\text{ V}$, $I_F<5\text{ }\mu\text{A}$
ON Resistance	R_{ON}	20	30	50	Ω	$I_T=\pm 25\text{ mA}$, $I_F=5\text{ mA}$
Turn-on Time	t_{ON}		0.9	2.0	ms	$I_F=10\text{ mA}$, $V_L=+50\text{ V}$ $R_L=1\text{ k}\Omega$
Turn-off Time	t_{OFF}		0.7	2.0	ms	

Figure 1. Timing test circuit

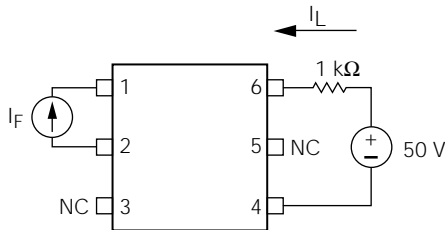

Figure 2. LED forward current vs. forward voltage

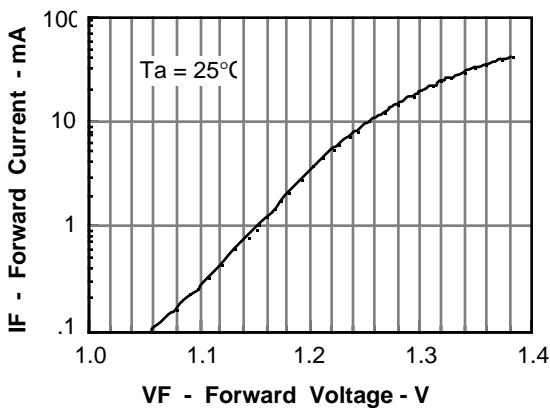

Figure 3. Timing waveform

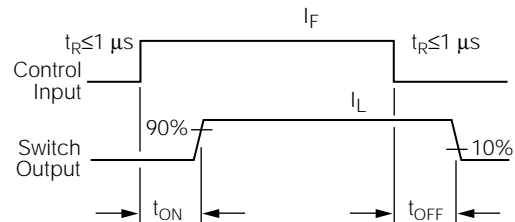

Figure 4. Terminal current vs. terminal voltage

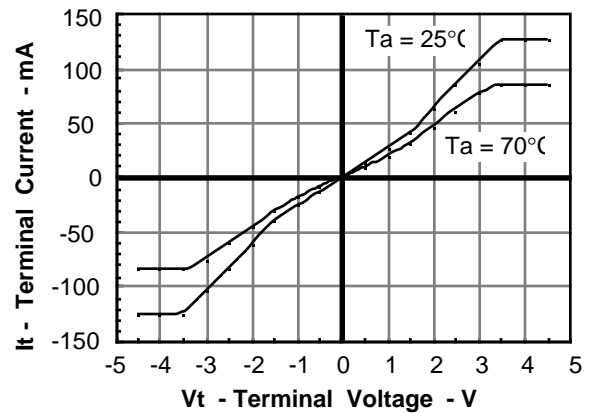

Figure 5. Turn on current vs. temperature

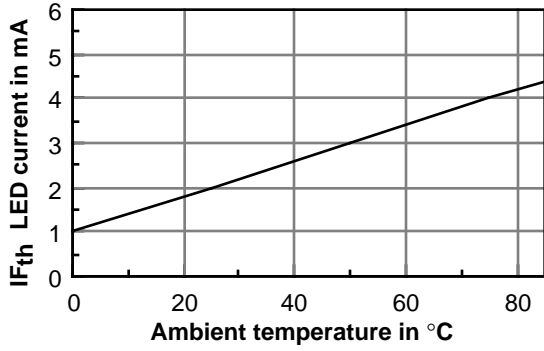

Figure 9. ΔR_{on} vs. temperature

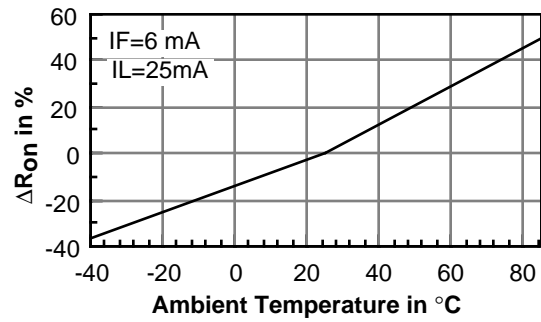

Figure 6. Load current vs. temperature

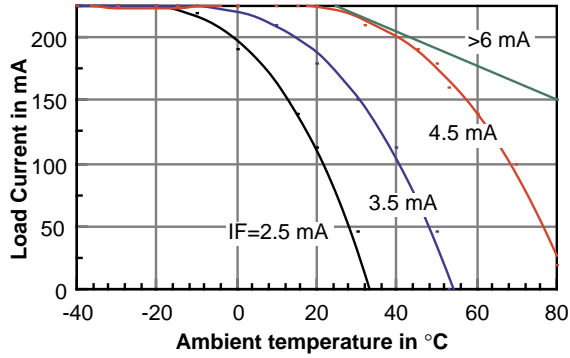

Figure 10. ΔT_{off} vs. temperature

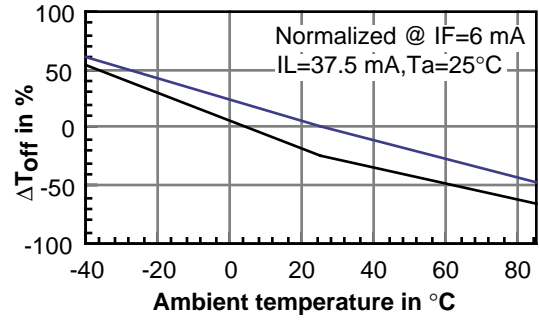

Figure 7. Derating of ILoad vs. temperature

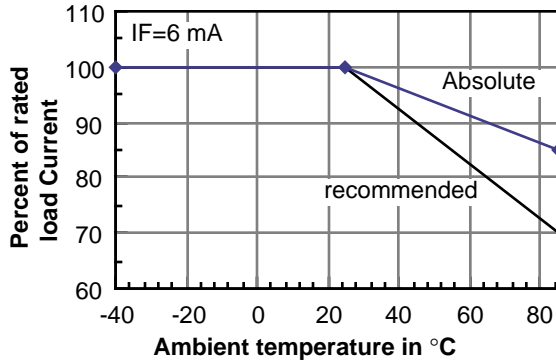

Figure 11. Change in Ton vs. temperature

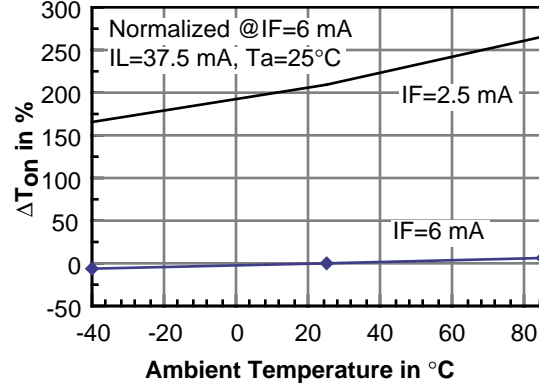

Figure 8. Change in I_{limit} vs. temperature

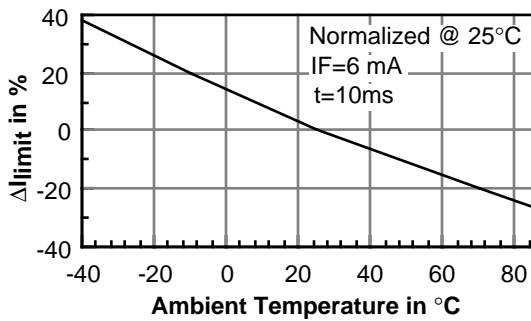

Figure 12. Turn-on and turn-off time vs. LED current

